

# ASSEMBLY INSTRUCTIONS



ID 0: 04/01/2025

# SOFA

# ASSEMBLY INSTRUCTIONS

## ASSEMBLY TIPS:

1. Remove hardware from box and sort by size.
2. Please check to see that all hardware and parts are present prior to start of assembly.
3. Please follow attached instructions in the same sequence as numbered to assure fast and easy assembly.



### WARNING!







1. Don't attempt to repair or modify parts that are broken or defective. Please contact the store immediately.
2. This product is for home use only and not intended for commercial establishments.

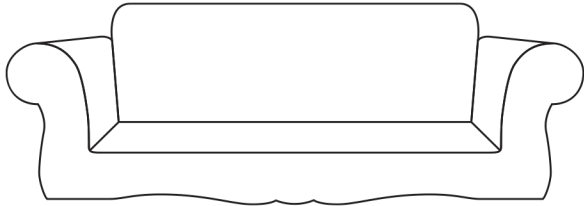

ASSEMBLY TIME

**15**  
MINUTES

## PARTS IDENTIFICATION

	PART NAME	FIGURE	QUANTITY
<b>A</b>	SOFA BASE		1 PC
<b>B</b>	SEAT CUSHION		2 PCS
<b>C</b>	BACK PILLOW		4 PCS
<b>D</b>	SMALL PILLOW		2 PCS
<b>E</b>	FRONT LEG		2 PCS
<b>F</b>	BACK LEG		2 PCS

## ASSEMBLY INSTRUCTIONS

**STEP 1** *Install front and rear legs on underside of sofa base.*

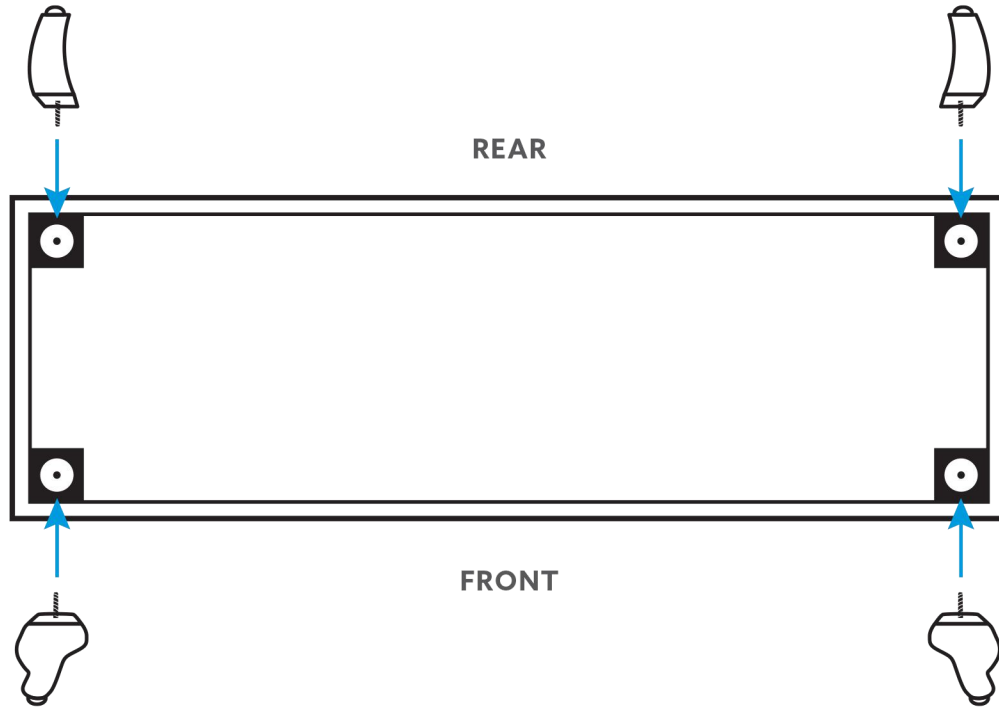

**STEP 2** COMPLETE

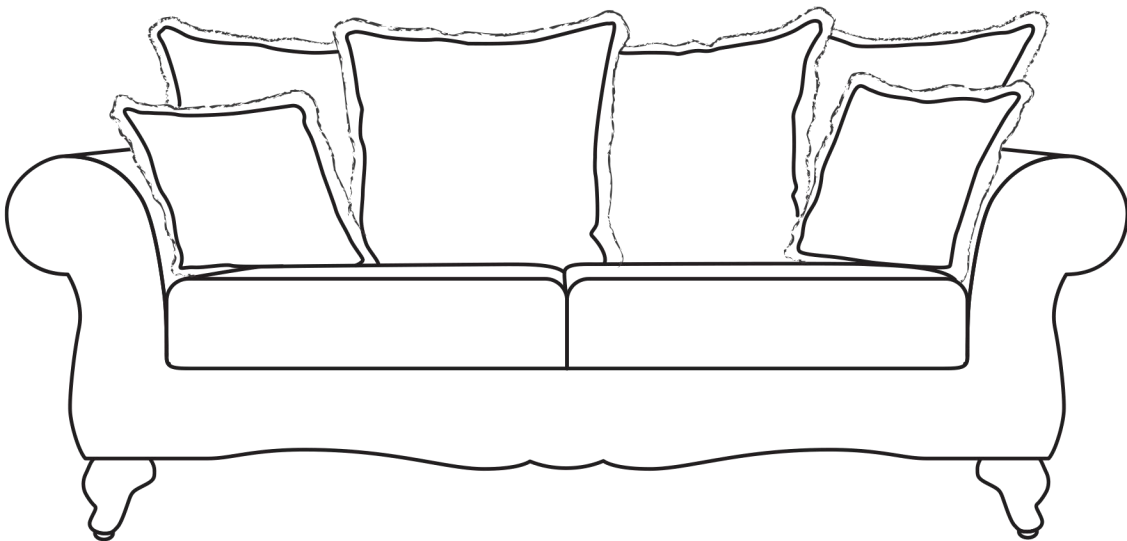

# DIMENSIONS

