

# ASSEMBLY INSTRUCTIONS

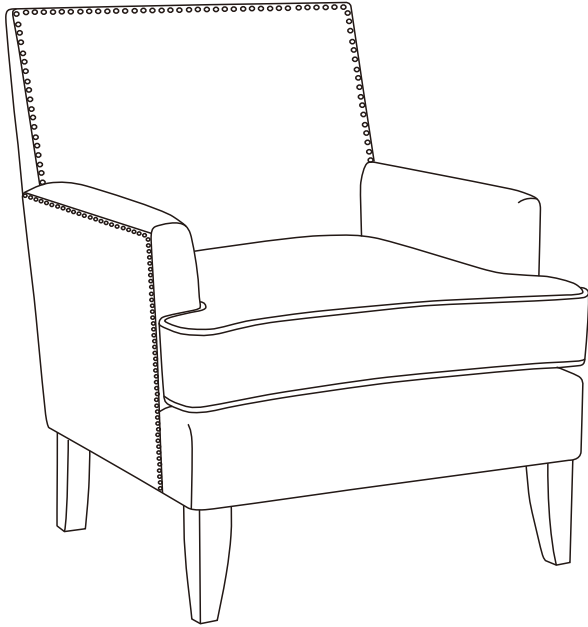

Ax1 	Ex12 
Bx1 	Fx12 
Cx2 	Gx1 
Dx2 	

1

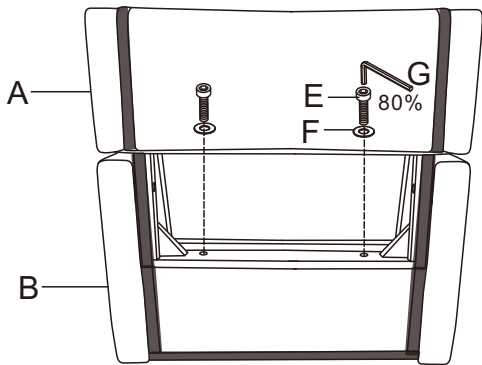

2

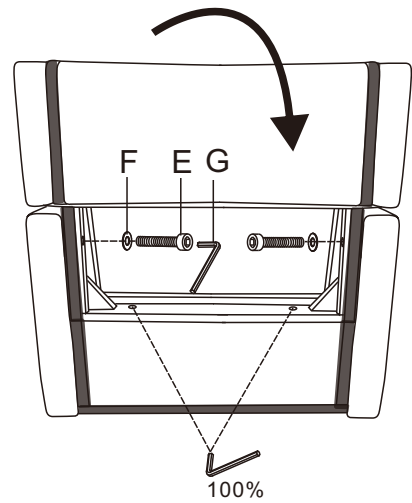

3

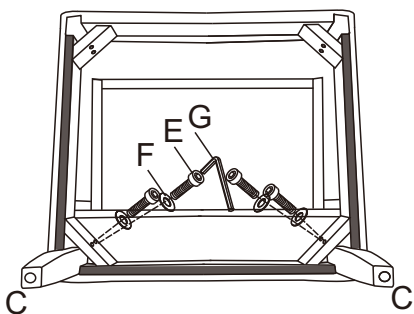

4

