

# CS1905-24

## Specifications & Dimension

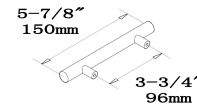

Handle's Dimension

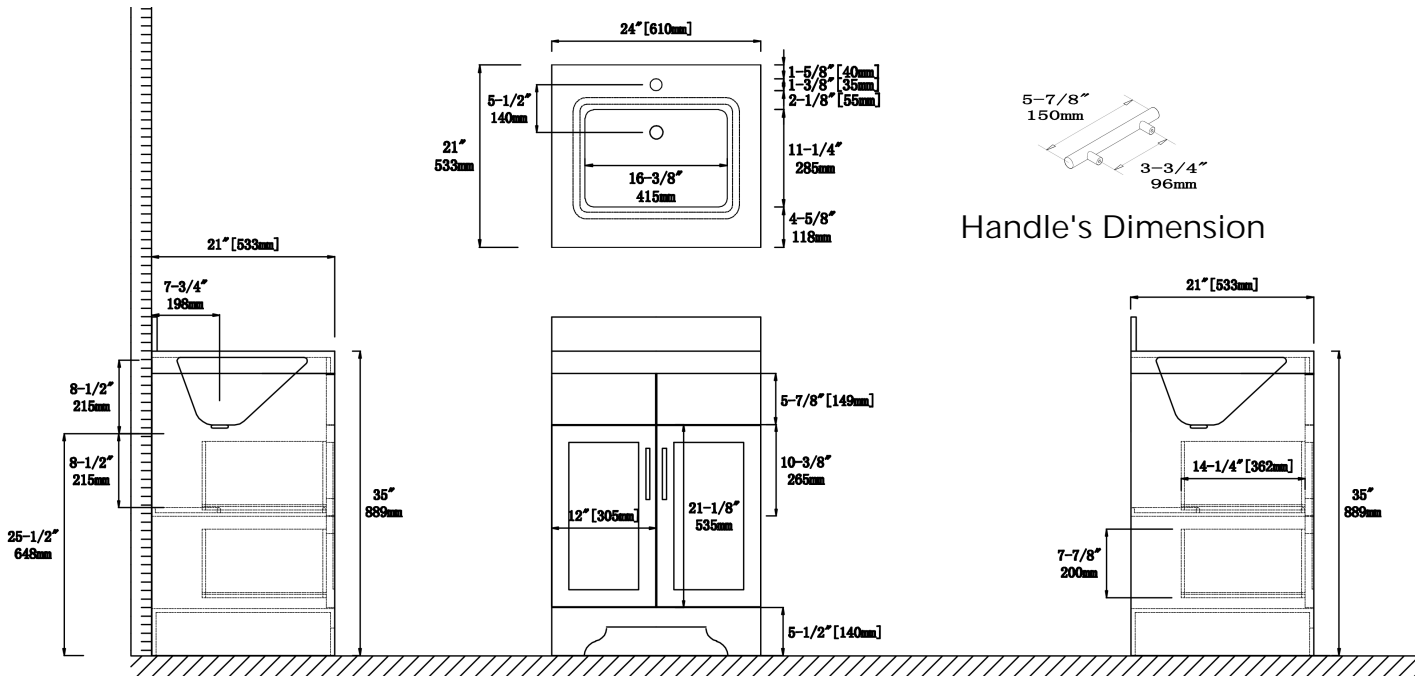
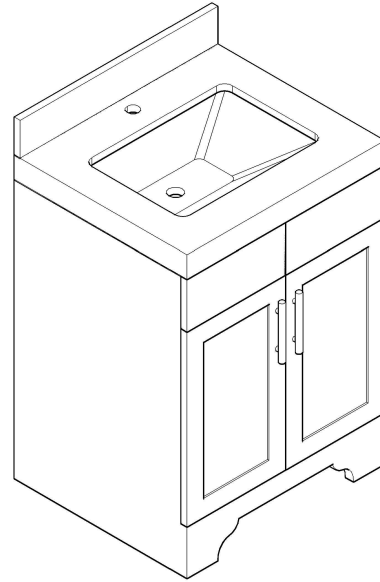