

# **VEVOR<sup>®</sup>**

**TOUGH TOOLS, HALF PRICE**

Technical Support and E-Warranty Certificate [www.vevor.com/support](http://www.vevor.com/support)

## **SIDEBOARD**

**MODEL: A02D.2056**

We continue to be committed to provide you tools with competitive price.

"Save Half", "Half Price" or any other similar expressions used by us only represents an estimate of savings you might benefit from buying certain tools with us compared to the major top brands and does not necessarily mean to cover all categories of tools offered by us. You are kindly reminded to verify carefully when you are placing an order with us if you are actually saving half in comparison with the top major brands.



# VEVOR®

TOUGH TOOLS, HALF PRICE

## SIDEBOARD

**MODEL: A02D.2056**

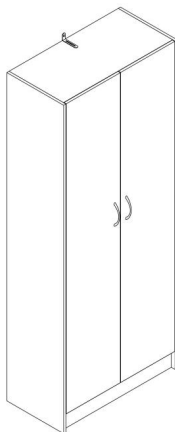



### **NEED HELP? CONTACT US!**

Have product questions? Need technical support? Please feel free to contact us:

**Technical Support and E-Warranty Certificate**  
**[www.vevor.com/support](http://www.vevor.com/support)**

This is the original instruction, please read all manual instructions carefully before operating. VEVOR reserves a clear interpretation of our user manual. The appearance of the product shall be subject to the product you received. Please forgive us that we won't inform you again if there are any technology or software updates on our product.

	<p>Warning-To reduce the risk of injury, user must read instructions manual carefully.</p>
 	<p>Wear eye protection. Wear protective gloves</p>

## SAFETY WARNINGS AND PRECAUTIONS

Thank you for using this product. In order to make sure that you can operate the machine correctly, read this instruction carefully before operation and keep it properly for future reference. Please be sure to read the precautions and safety rules in this page to ensure your safe use. This manual will outline safety warnings and precautions, operating, maintenance and cleaning. The warnings and instructions reviewed in this manual cannot cover all possible conditions and situations that may occur. Caution and common sense are not built into this product, since we believe that the uses will comply with these codes.

**Please read ALL the instructions before using your machine.**

1. Assemble needs to follow these instructions. Incorrect assembly can be a hazard.
2. Wear safety goggles and heavy-duty work gloves during assembly.
3. Do not assemble when tired or when under the influence of alcohol, drugs or medication.
4. Weight and other product properties are only applicable to correctly and completely assembled products.
5. Keep the assembly area clean and well-lit.
6. Keep bystanders out of the area during assembly.
7. This product is not a toy. Do not allow children and pet to play with or approach this item.
8. Use as intended only. Do not sit or stand on the product.
9. Inspect before every use. Do not use it if parts are loose or damaged.
10. For indoor use only.

11. Do not exceed the listed weight capacity. Tighten all knobs securely before applying load. Be aware of dynamic loading! The sudden load movement may briefly create an excess load, causing product failure.
12. Do not apply this unit to any other purposes than the indicated usage.
13. Do not use it outdoors or for commercial purposes. INDOOR USE ONLY.
14. DO NOT CLEAN IT WITH ANY ABRASIVE MATERIAL.
15. Never leave it unattended while in use.
17. Pay attention to hand injuries caused by drawer pinching!
18. Do not place the product on or near hot air, electric burners or heaters.
19. Do not place in a damp environment.
20. The product should be placed on a flat surface.



**WARNING: TO PREVENT SERIOUS INJURY AND DEATH FROM TIPPING:  
20. Attention: An anti tipping device must be installed to securely secure the product to the wall (Ensure the reliability of the wall itself).**

**21. This appliance is not intended for use by young or infirm persons unless supervised by a responsible person to ensure that they can use the appliance safely. Young children should be supervised to ensure that they do not play with the product. Children and pets should stay away from the product.**

## PRODUCT PARAMETERS

MODEL	Loading Capacity
A02D.2056	Max50Kg (About 110LBS)

### CAUTION:









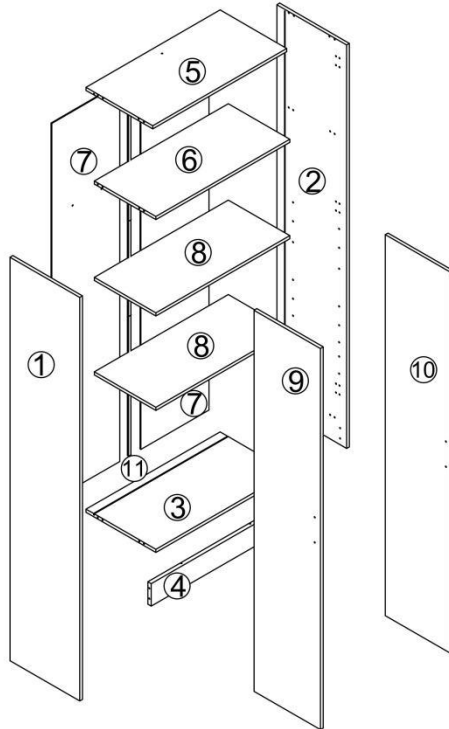





1. **Do not** place all the weights on the same layer!
2. Place the weight evenly on each layer plate to achieve the maximum bearing capacity!

## ASSEMBLY STEPS

1. Please dispose of all plastic bags carefully and keep them away from children and pet.
2. Check all components provided according to the list in this manual. Make sure you have all of the parts listed.
3. Whilst every care is taken in the manufacture of this product, care must be taken during assembly in case sharp edges are present.
4. Wear eye protection, protective gloves, during assembly and using.
5. The product should be placed on a flat surface.
6. The product requires two people to assemble.
7. The product requires the use of a rubber hammer and a Phillips screwdriver (Rubber hammer and cross screwdriver need to be purchased by oneself).
8. If uneven product gaps are found, they can be disassembled and adjusted.

**Attention: An anti tipping device must be installed to securely secure the product to the wall (Ensure the reliability of the wall itself).**







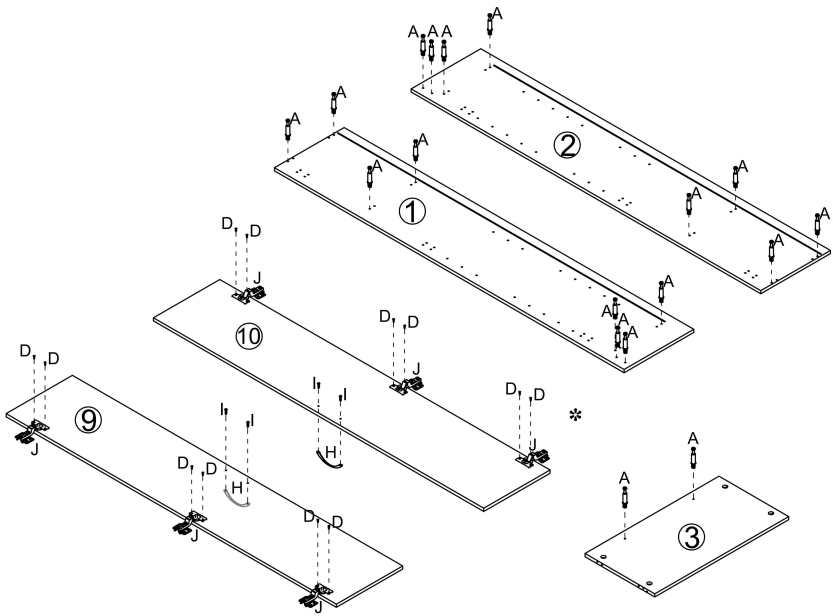

 A x18 6x35mm	 B x18 Ø15x9.5mm	 C x12 6x30mm	 D x36 4x14mm	 E x8 3x16mm	 F x8 5x25mm	 G x8	 H x2
 I x4 4x16mm	 J x6	 K x1 4x12mm	 L x1 70x25mm	 M x1 4x35mm	 N x1 6x30mm	 O x4 3x12mm	

- 2 -

**Note: the quantity of parts shown in the manual is the actual usage and the unused parts are spare parts.**

# Step 1



A		18
D		12
H		2
I		4
J		6

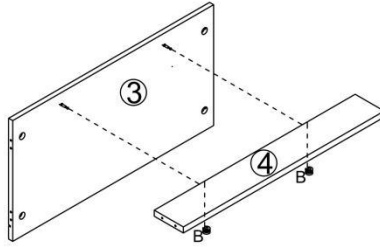

## Step 2

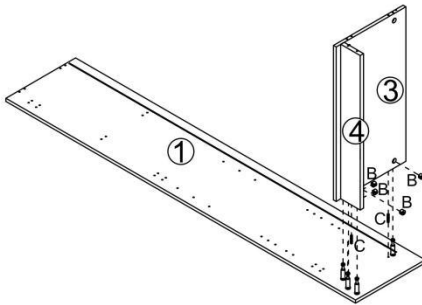

B		2
---	---	---

## Step 3



B		4
C		2

## Step 4

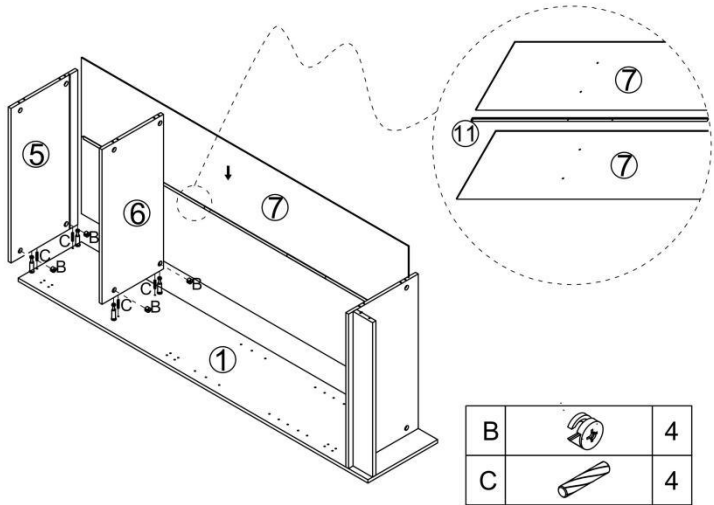

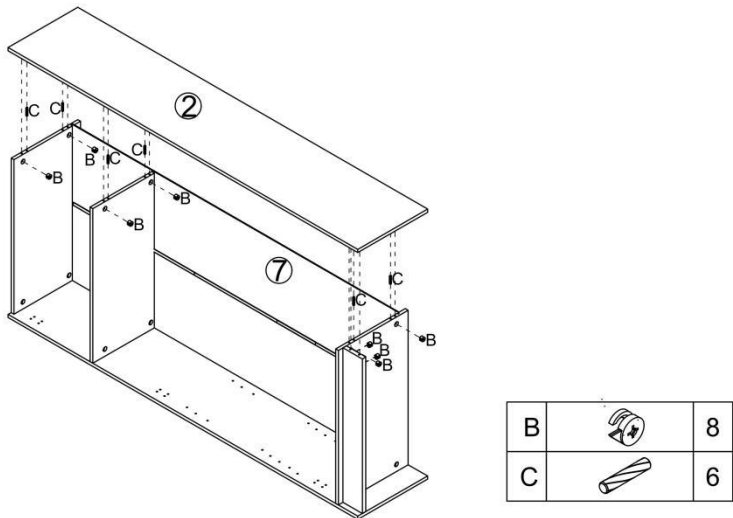

## Step 5

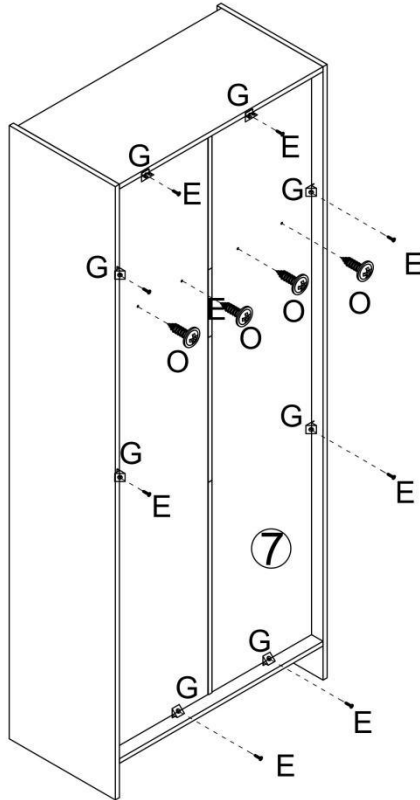

# Step 6



E		8
G		8
O		4

## Step 7



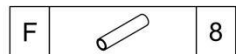
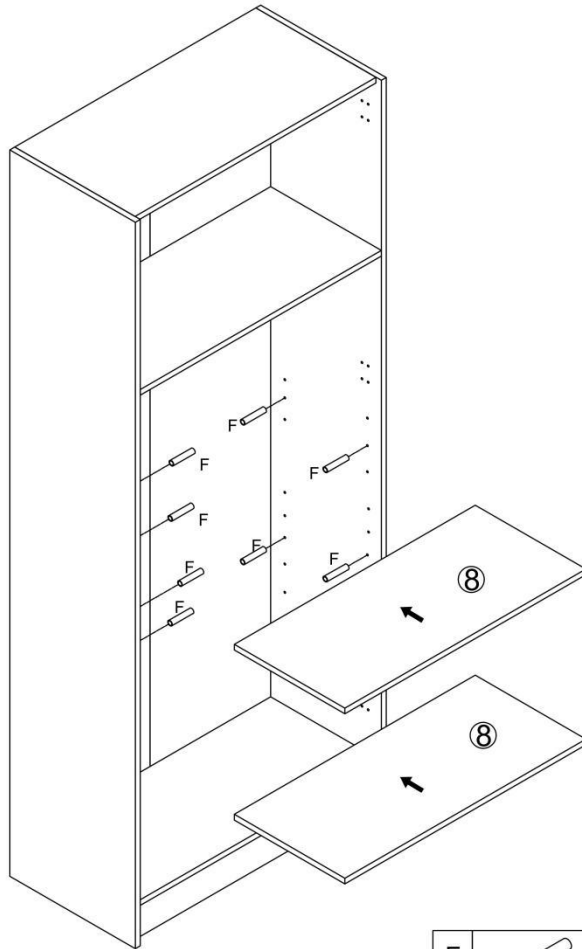

**Notice:** Please adjust the height of the laminate according to the usage needs.

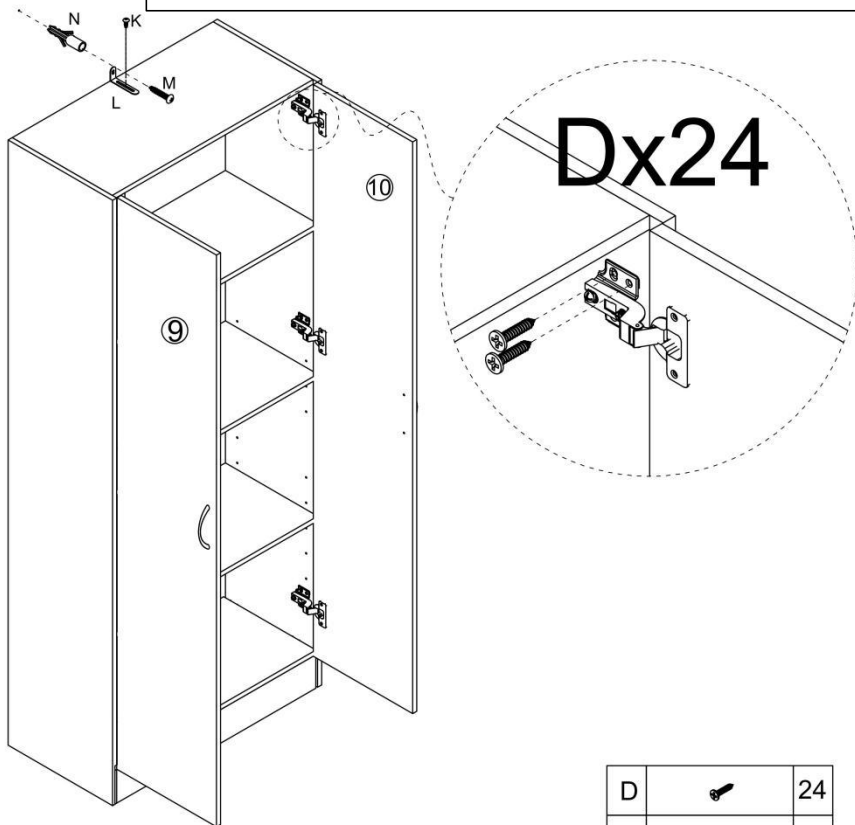

## Step 8

**Attention: An anti tipping device must be installed to securely secure the product to the wall (Ensure the reliability of the wall itself).**



D		24
K		1
M		1
N		1

## CLEANING AND STORAGE

1. Wipe with a soft, dry cloth. Never use an abrasive cleanser or harsh pad. Do not clean with water or other liquids.
2. Be sure to keep the product dry
3. Children are **not allowed** to wipe the product to avoid tipping and falling injuries.
4. Regularly adding industrial grease to the door spindle and drawer slide can reduce noise and extend service life.

### **TIPS:**

5. Adding PVC pads for easy cleaning.

### **Sanven Technology Ltd.**

**Address:** Suite 250, 9166 Anaheim Place, Rancho Cucamonga, CA 91730

**Made In China**



**VEVOR<sup>®</sup>**

**TOUGH TOOLS, HALF PRICE**

**Technical Support and E-Warranty Certificate**

**[www.vevor.com/support](http://www.vevor.com/support)**