

Assembly Instruction

TAB185A

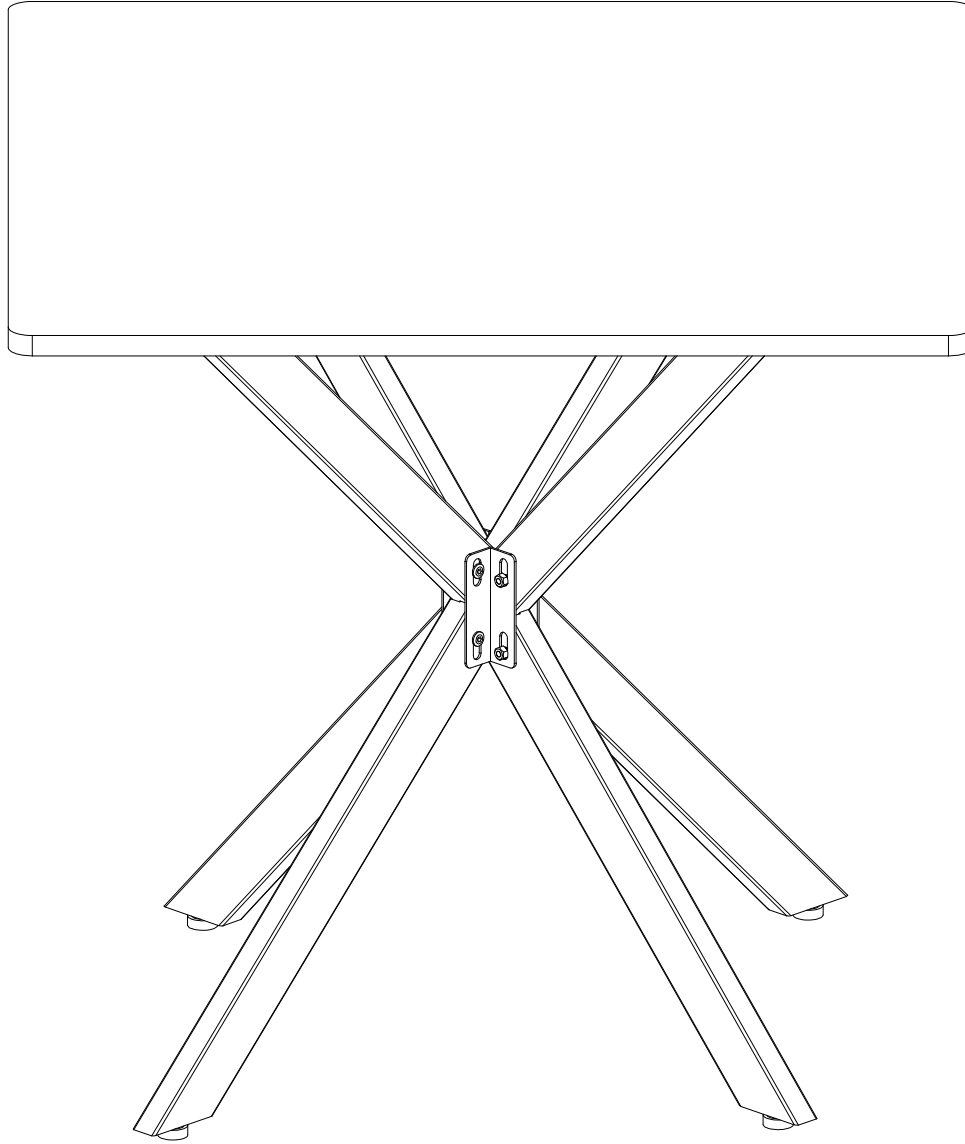

“

Warm Reminder

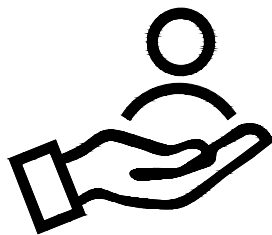

If you experience any issues with our product (including missing parts, damage, installation issues, or not meeting expectations), please contact us. We'll ensure satisfactory assistance within 24 hours.

Email: vipservice2023@yeah.net

”



General Guidelines

- Please read the following instructions carefully and use the product accordingly.
- Please keep this manual and hand it over when you transfer the product.
- This summary may not include every detail of all variations and considered steps. Please contact us when further information and help are needed.

Notes

- The product is intended for indoor use only. The product must be assembled and used in accordance with the provisions of the manual. Personal injury and/or damage to the product may occur if products are used outside of their intended purposes and/or if products have been changed/modified from their original design.
- The seller does not assume any responsibility or liability with respect to any injury/damage caused by incorrect assembly or improper use.
- Avoid long-term exposure to humid environments to prevent mildew.
- Keep the product away from fire sources and high temperatures. Do not expose the product to direct sunlight.
- Do not place any hot objects on the surface of the product.
- If there are any defective or missing parts after unpacking, please cease assembly immediately and contact us.
- Please assemble the item on a spacious surface and do not place the unwrapped product directly on the ground to avoid product damage.
- Please do not stand or sit on the wooden boards.
- Please wear gloves during the assembly and/or disassembly process to avoid scratches from any sharp edges.
- Please match the corresponding part and fitting based on the part number in the manual.
- If the part does not match with the fitting, please check the piece as specified in this manual.
- During assembly, first loosely align all screws with the corresponding pre-drilled holes and then tighten the screws one by one.
- Periodically inspect screw tightness while the product is in use. If necessary, retighten to ensure structural integrity.
- If you accidentally spill water or another liquid on the surface, immediately wipe clean with a dry towel.
- Please keep the product away from sharp, pointed objects and corrosive substances to prevent product damage.
- Please place this item on level, solid ground during use.

Warnings

- During assembly, keep all small parts out of the reach of children. It may be fatal if swallowed or inhaled.
- Children should not climb or play on the product in order to avoid tipping over the furniture and causing serious injury.
- To avoid the potential dangers of suffocation, please keep all parts and packaging (film, plastic bags, foam, etc.) away from babies and children.
- Keep sharp objects and corrosive items away from the product to avoid any damage or injury.
- Do not shake or move violently during use to avoid tipping over the product.

Email: vipservice2023@yeah.net

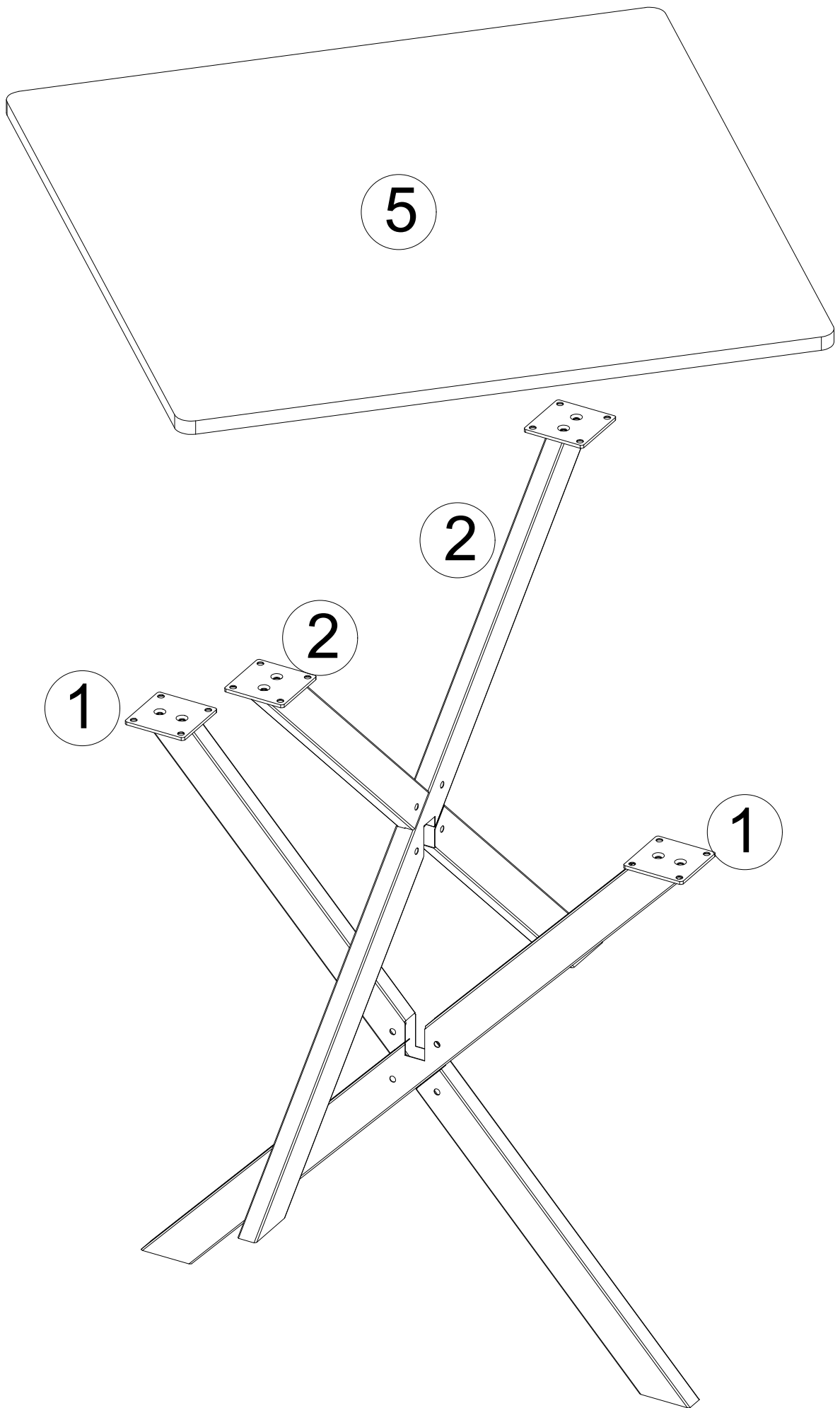

Part list

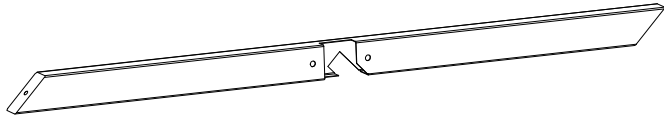

Short pipe

① X2

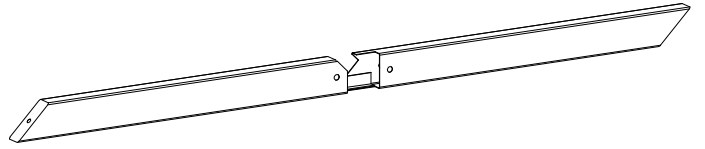

Long tube

There is an iron sheet inside, which is the No. 2 pipe

② X2

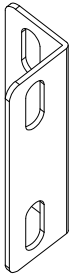

③ X4

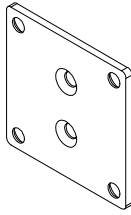

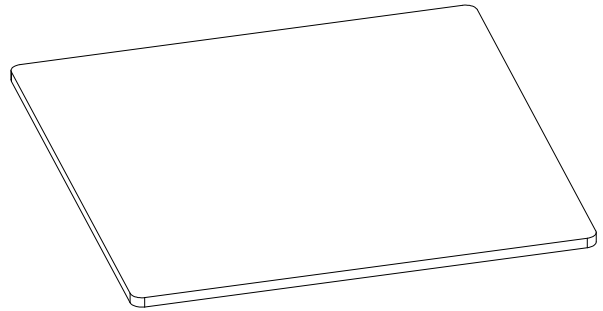

④ X4

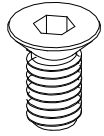
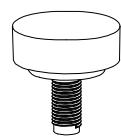
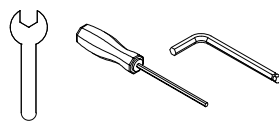

⑤ X1

Hardware list

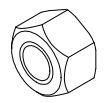
<p>A</p>  <p>M6*12MM</p>	<p>B</p> 	<p>C</p> 	<p>D</p>  <p>M6*40MM</p>	<p>E</p>  <p>M6</p>
<p>24pcs (2 Extra)</p>	<p>4pcs</p>	<p>1pc</p>	<p>8pcs (1 Extra)</p>	<p>8pcs (1 Extra)</p>

Ensure that the screw of part number ④ is installed in place

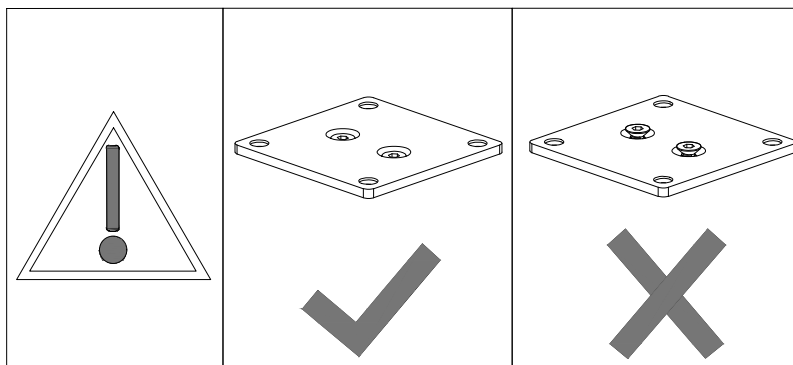

step 1

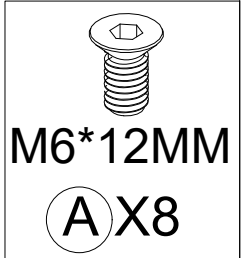
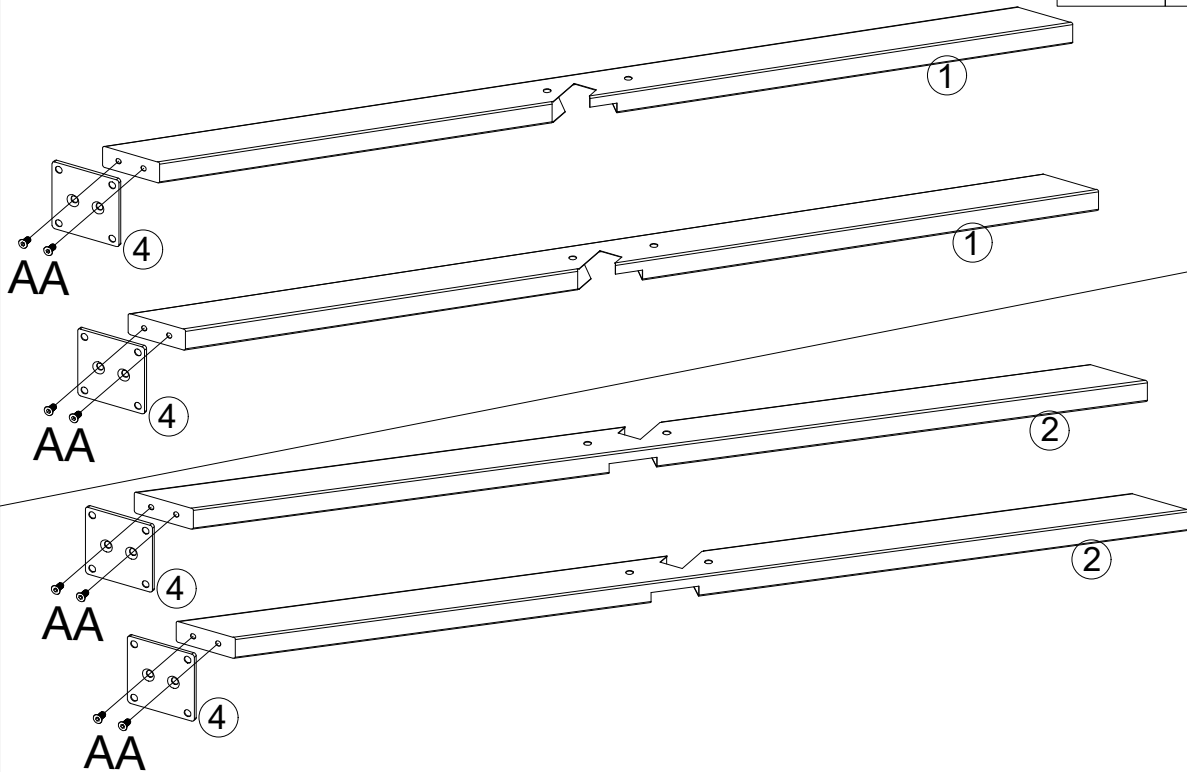
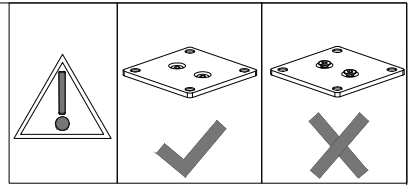

step 2

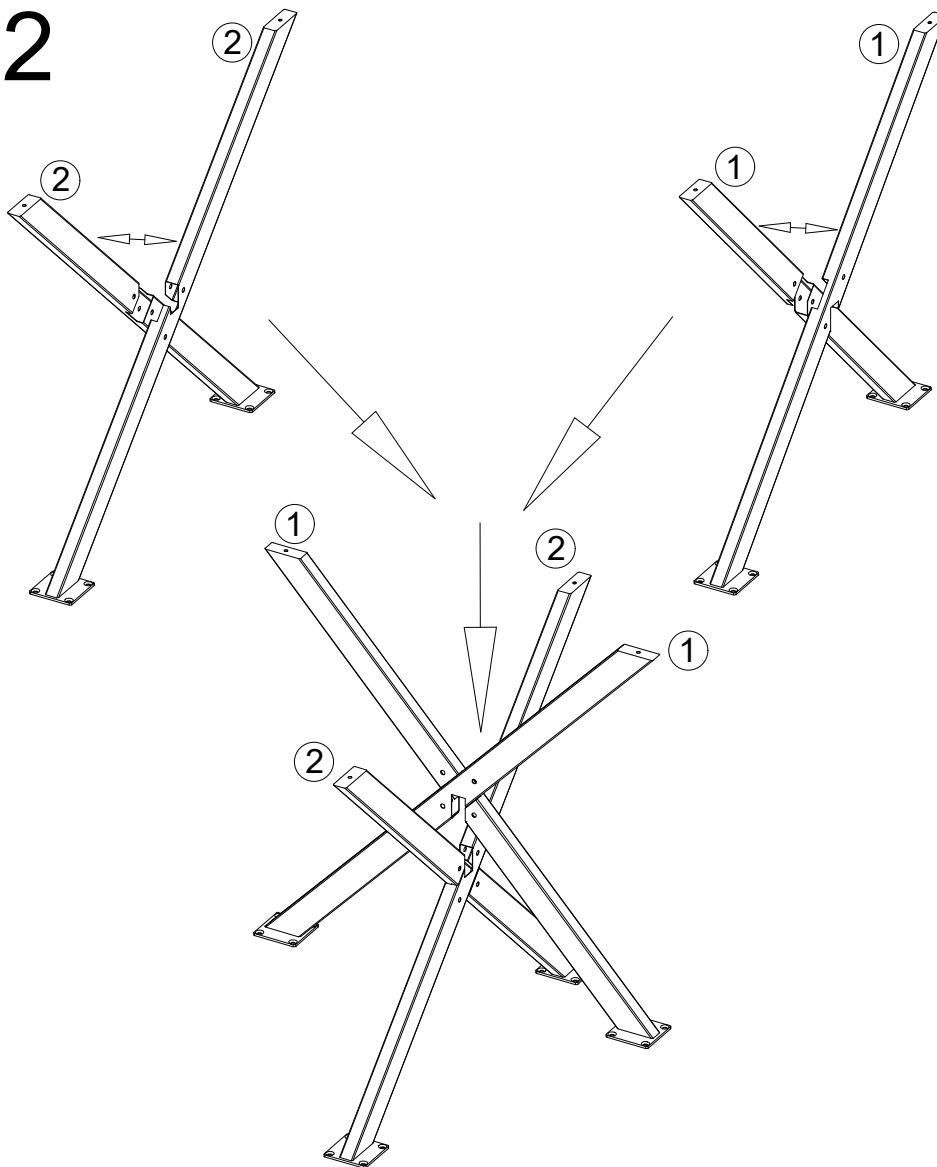

step 3

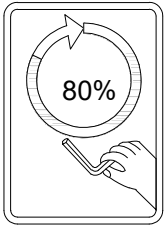

80% tighten bolts.



If the hole position is not aligned with the hole position on the wooden board, please rotate the frame 90 ° before installation

Note: Part ① and Part ② have different lengths. Part ② is longer

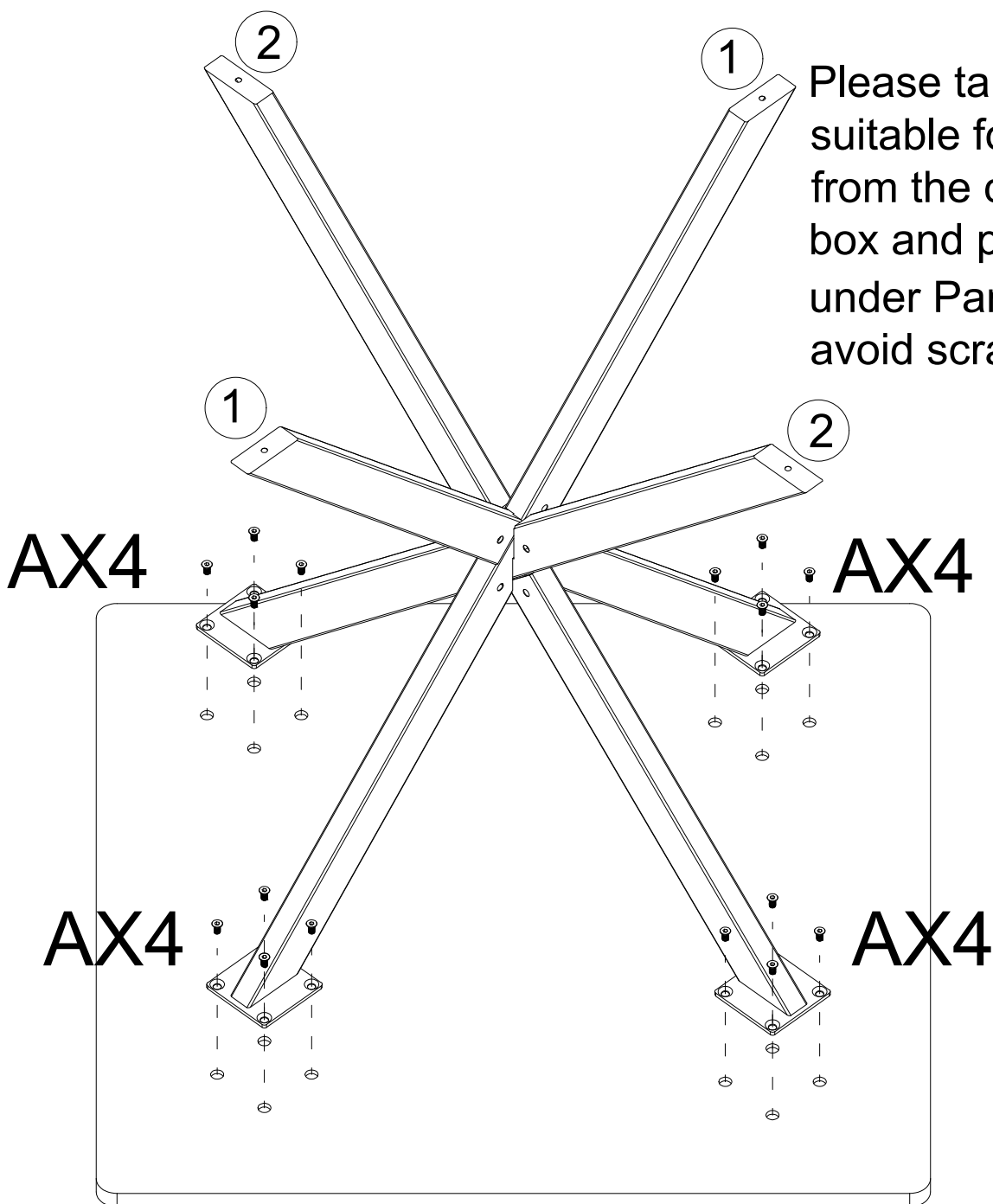

Please take a suitable foam pad from the cardboard box and place it under Panel ⑤ to avoid scratching it

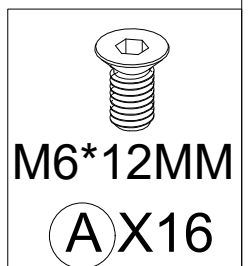

M6*12MM

AX16

step 4

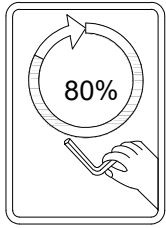

80% tighten bolts.

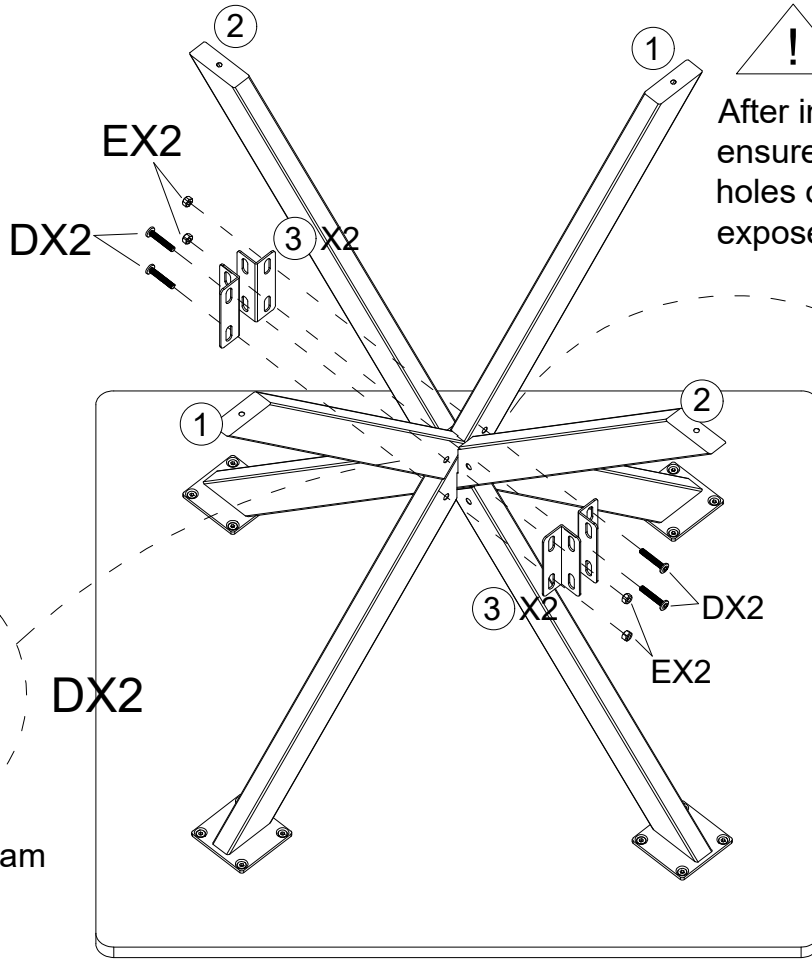

After installing Part ③, ensure that the mounting holes on both sides remain exposed for the next step

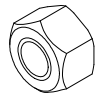
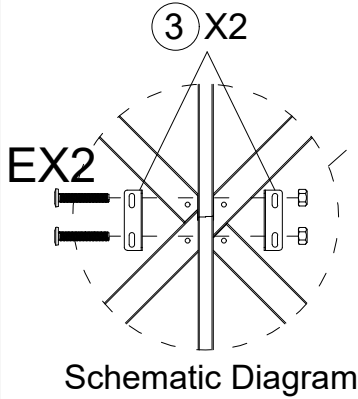
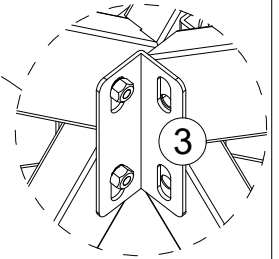

M6
E X4



M6*40MM
D X4

step 5

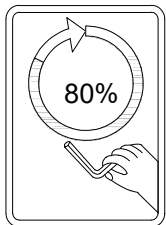

80% tighten bolts.



Pay attention to aligning the installation holes

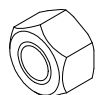
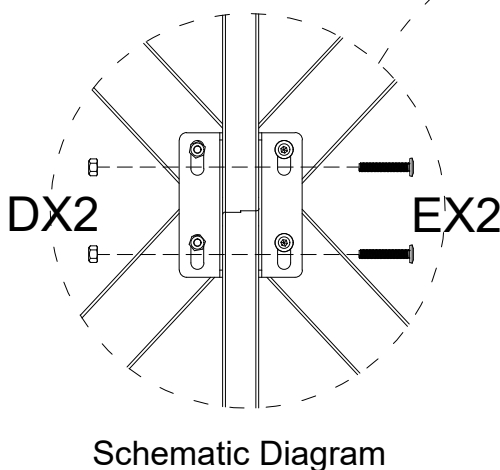
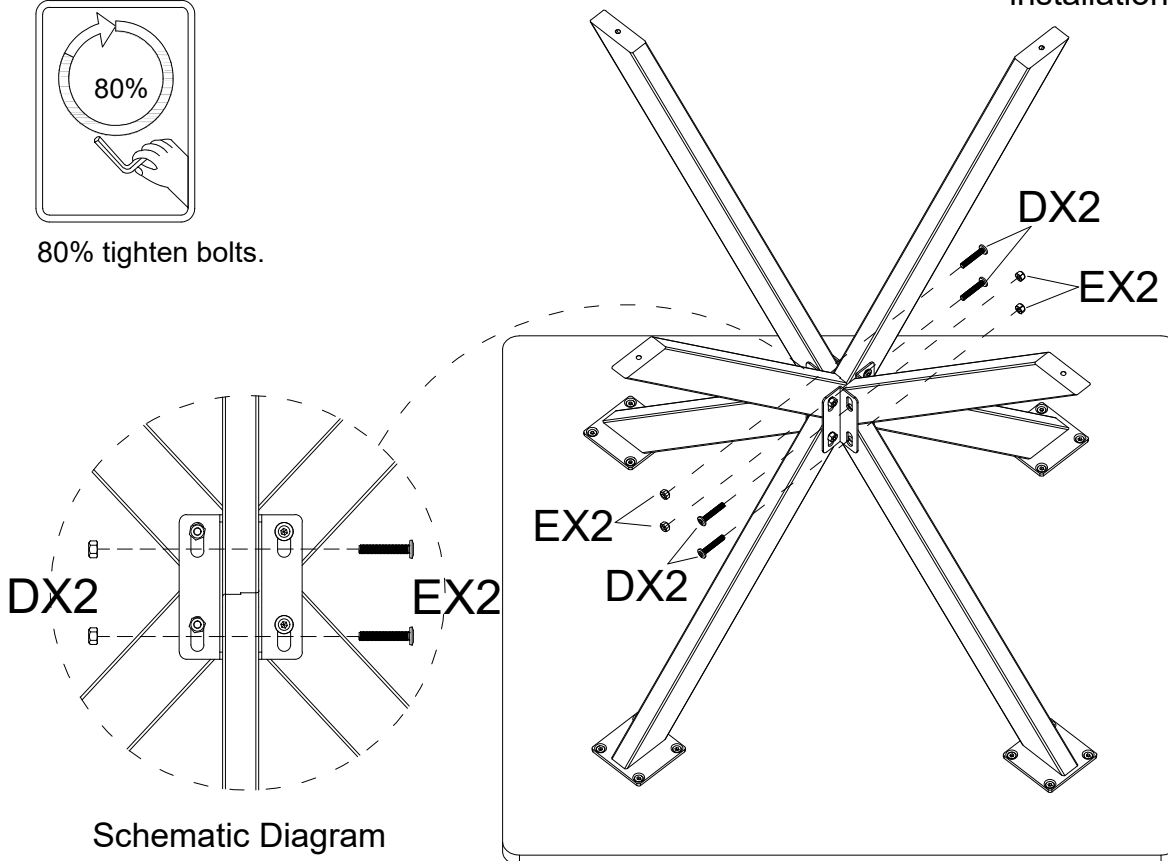

M6
E X4

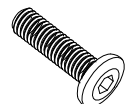

M6*40MM
D X4

step 6

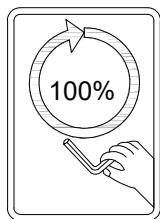

After installation,
tighten the remaining
screws to 100%

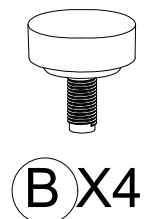
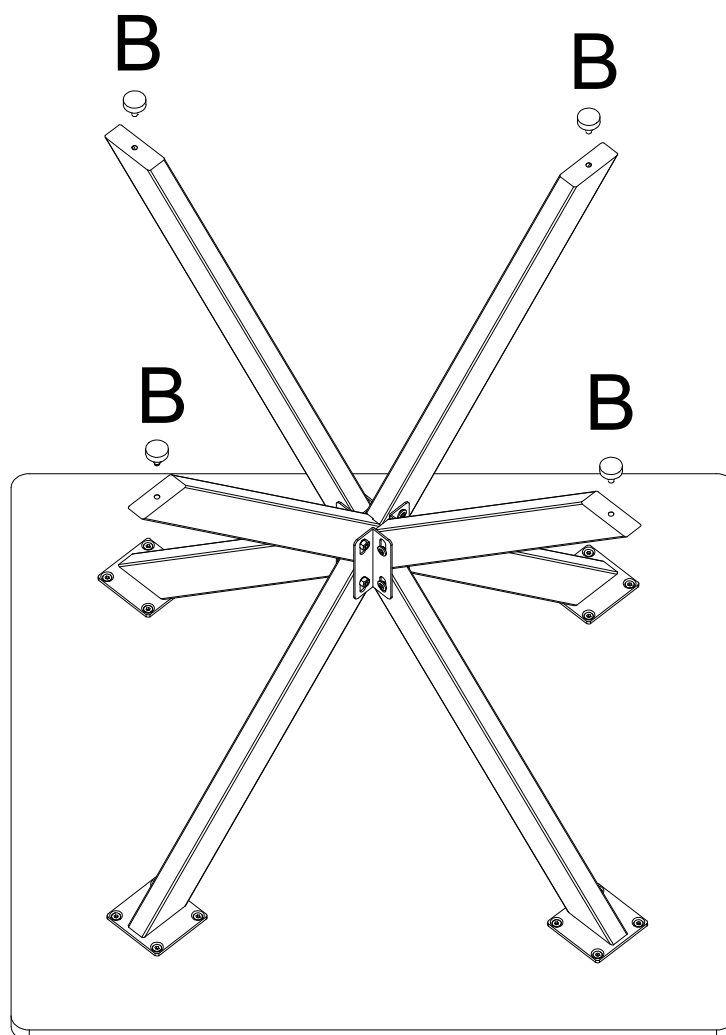

Complete

