

Top View

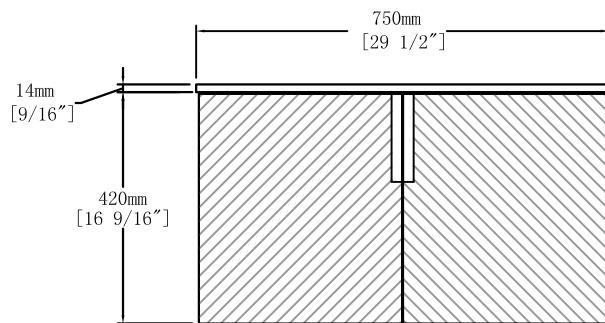

Front View

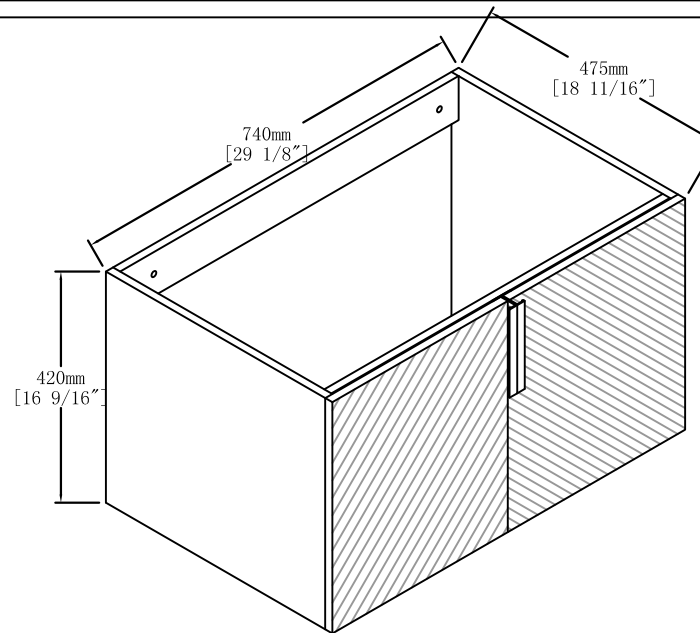
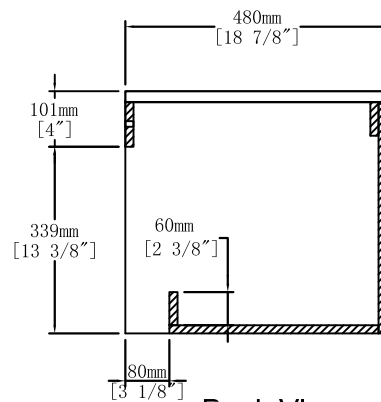

Back View

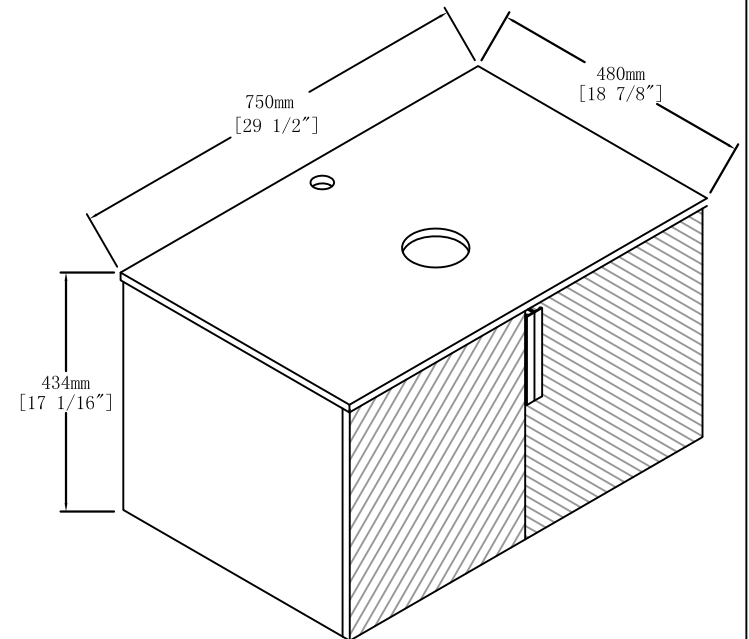

Item NO.

BV B13530

Version

V1

Project

Date

2025-6-16