

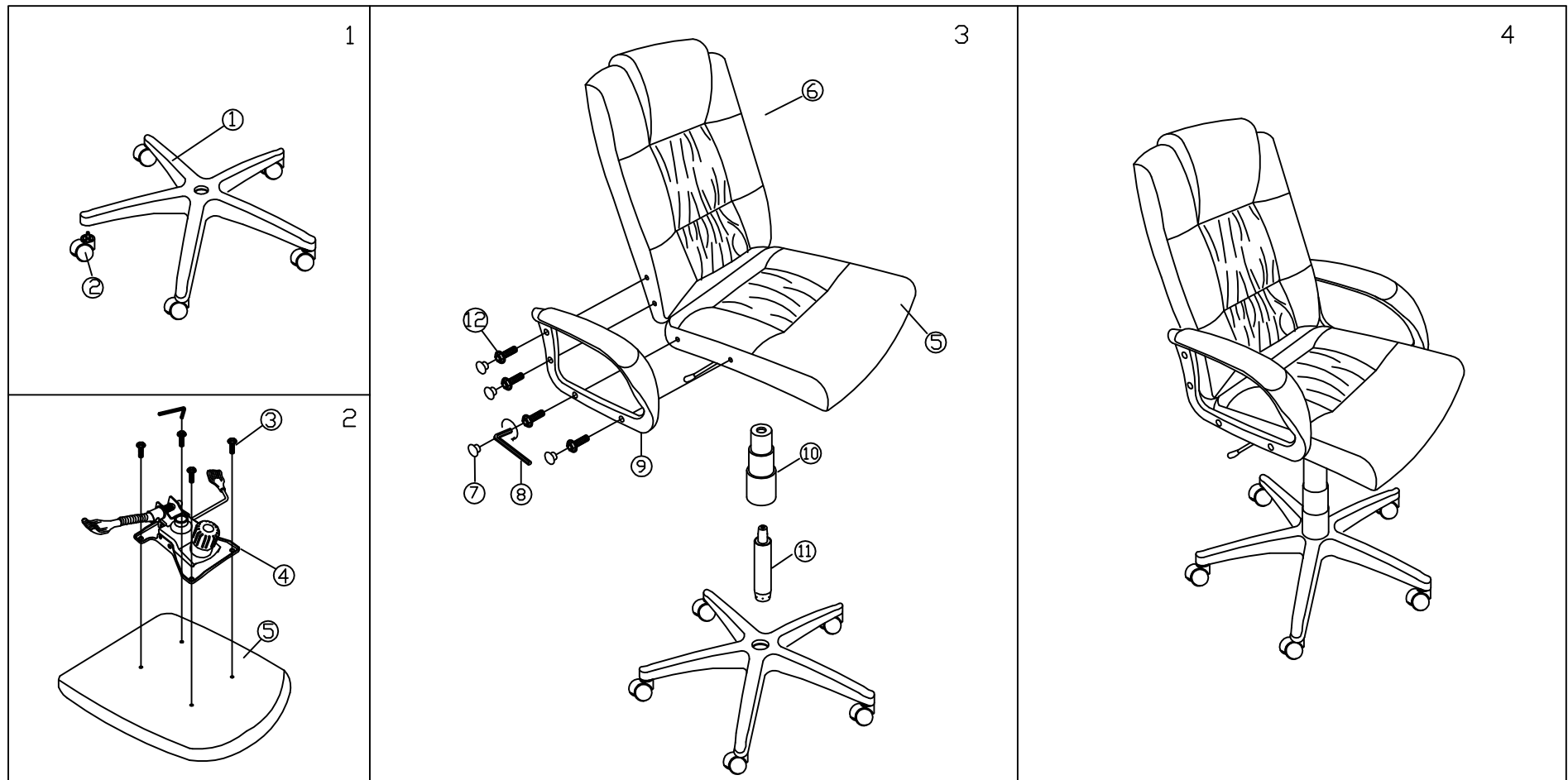











Moore ASSEMBLY INSTRUCTION



① 5-STAR BASE	② CASTOR	③ SCREW	④ MECHANISM	⑤ SEAT CUSHION	⑥ BACK CUSHION	⑦ PLASTIC CAP	⑧ ALLEN KEY	⑨ ARMREST	⑩ DUST COVER	⑪ GAS LIFE	⑫ SCREW
		M6*25									M6*20
											
1 PC	5 PCS	4 PCS	1 PC	1 PC	1 PC	8 PCS	1 PC	1 PAIR	1 PC	1 PC	8 PCS

IMPORTANT NOTE - PLEASE ASSES ALL COMPONENTS PRIOR TO DISPOSAL OF PACKAGING AND ASSEMBLY OF CHAIR