



Assembly Instructions

Caution : You must read this before you proceed

Umbrella



Parts List





Label	Picture	Description	QTY
A		Umbrella Cap	1
B		Umbrella (Pre-attached with Support Pole)	1

C		Base Pole	1
---	---	-----------	---

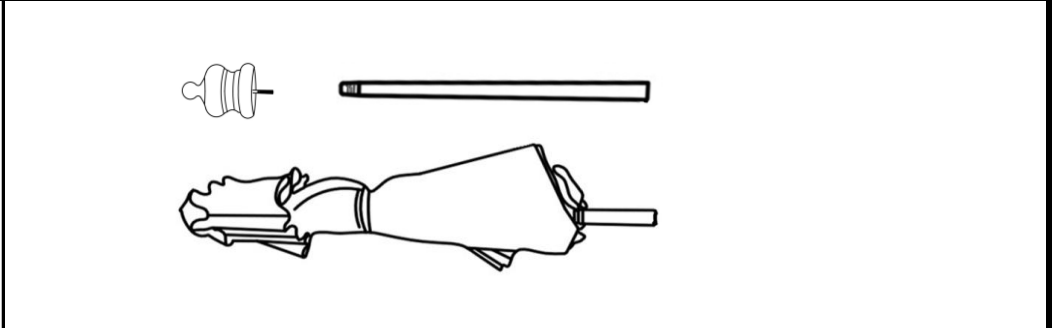
Assembly Preparation

Before Beginning Assembly:
Unpack all the parts for a clear



-  • Read instructions, cover to cover-
-  • Have 2 adults on hand for assembly-
-  • Do not assemble on flooring or carpet-
-  • Assemble on a clean non-marring surface (packing foam)-
-  • Save all packaging until finished-

Assembly Steps

Overview

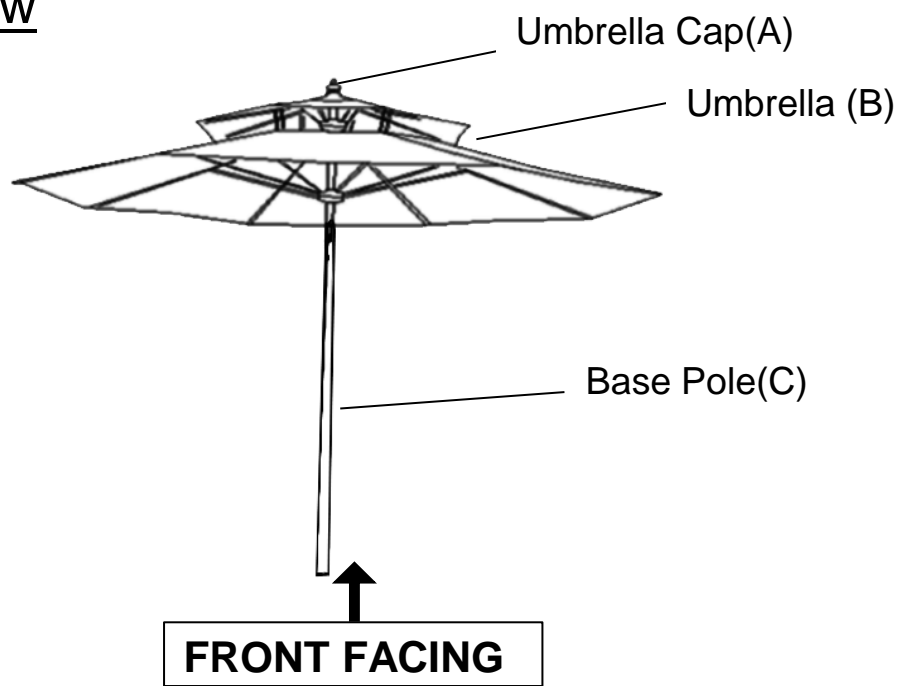

This Umbrella has multiple parts and may require up to 30 minutes to assemble. To give you an overview of the Umbrella parts, the above picture is to help you put the various parts into perspective. Please read through the instructions below to familiarise yourself with the parts and steps before assembly.

Step 1

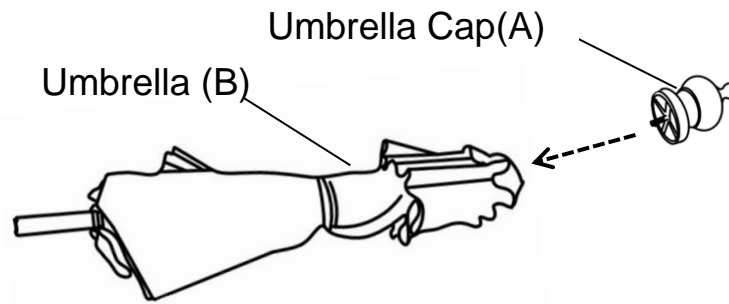

Screw-in the Umbrella Cap(A) to the top of the Umbrella(B) by hand

Step 2

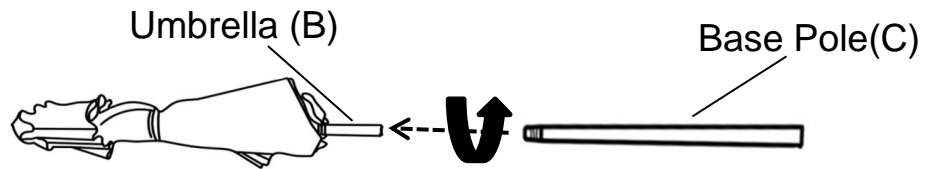

Insert Base Pole(C) into Support Pole of Umbrella(B) and tighten by turning Base Pole(C) clockwise by hand.

Step 3

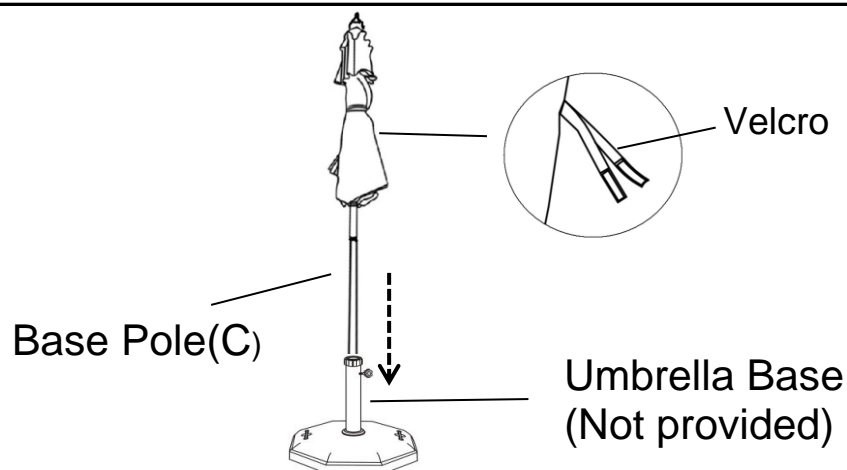

Insert Base Pole(C) into tube of Umbrella Base(Not provided)

Note: This Umbrella requires the matching tube of the Umbrella Base to be Dia. 38mm, and must be ≥ 30 kg.

Then open the Velcro, your Umbrella is ready for use.

Caution: The Umbrella is heavy, take care of your safety and have an adult helper.

Operation Steps

Step 1

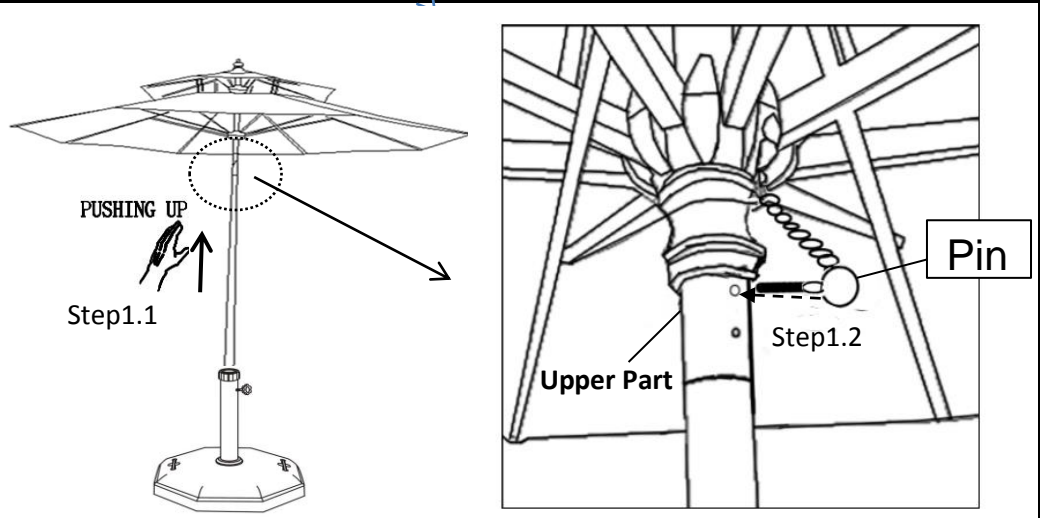

Step1.1) Open the Umbrella by pushing the Umbrella Upper Part upwards until it reaches the mounting position.

Step1.2) Lock the Umbrella into place by inserting Pin into mounting position.

Step 2

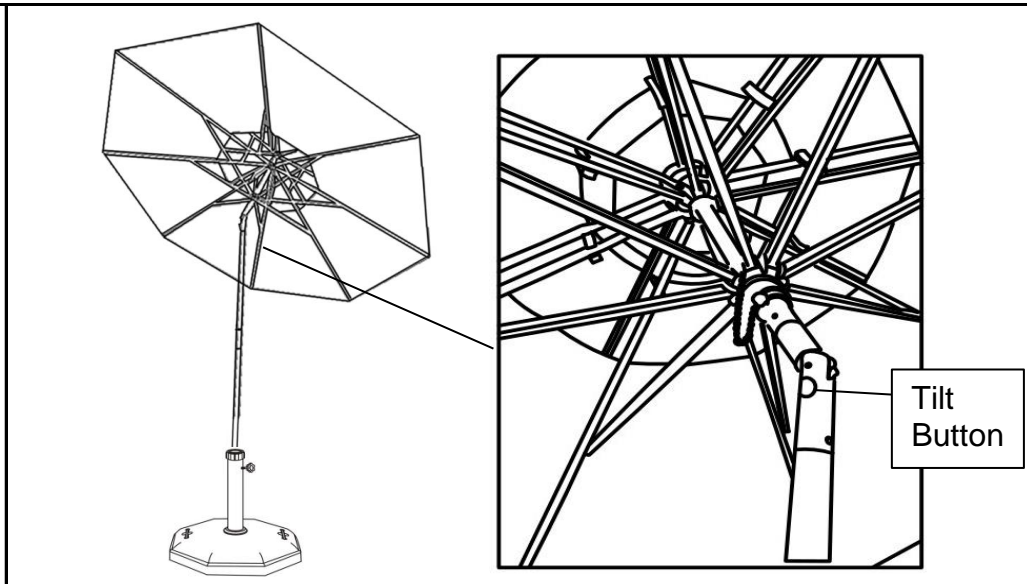

To adjust the angle of the Umbrella Press the Tilt Button on the top of Umbrella(B), adjust to desired position and release.

Step 3

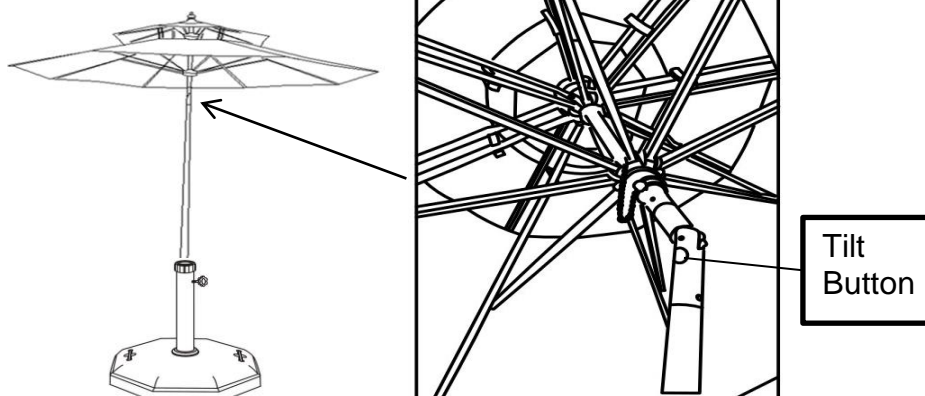

To return the Umbrella to it's original position, Press the Tilt Button again, and straighten the Umbrella by hand, then release.

Caution: Always close the Umbrella when not in use and never use the Umbrella during strong, windy conditions.

This Umbrella can only be used on a flat, level surface.

Step 4

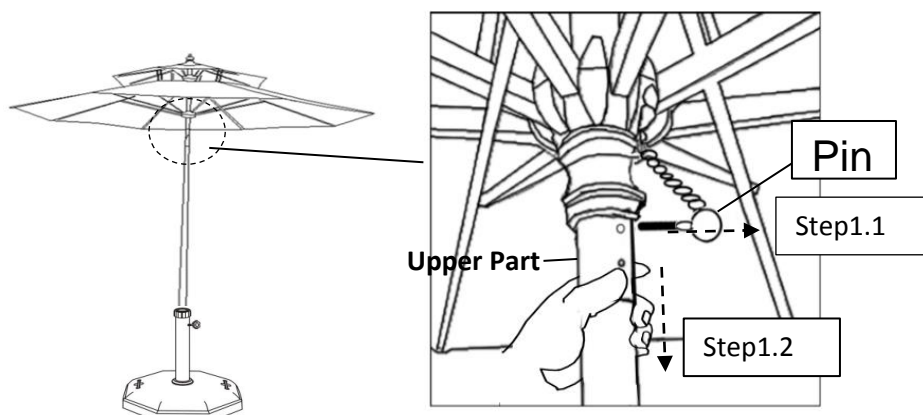



















Step1.1) Holding the Umbrella Upper Part by hand and Unlock the Umbrella by pulling out the Pin out of mounting position.

Step1.2) Close the Umbrella by pull the Umbrella Upper Part downwards , and stick the Velcro.

Caution: Always close the Umbrella when not in use, and never use during strong, windy conditions.

Care & Maintenance

-   • Do not put hot items directly on furniture surface
 -   • Do not clean furniture with harsh cleansers or polish.
 -   • To obtain the longest lifespan of your outdoor products, minimizing exposure to direct sunlight is recommended.
 -   • Children should not climb or jump on the furniture.
 -   • Do not write on furniture without a padded barrier to protect the surface.
 -   • To obtain the longest lifespan of your outdoor products, avoid extended and lengthy exposure to rain, snow, and direct sunshine. Whenever possible cover the product and /or place under patio or awnings.
 -   • Not for commercial use. For residential use only .
 -   • Stains may be removed with mild soap solution and damp cloth.
-
-   • Dust and pick-up spills using a clean, non-colored, lint-free cloth .

What is Proposition 65?

Proposition 65 is a California law that requires warning labels on products that may contain one of more than 800-plus chemicals or ingredients that the California Office of Environmental Health Hazard Assessment (OEHHA) has deemed to cause cancer or other reproductive toxicity. Chemicals and elements on this list include wood dust, brass, and other everyday substances, which can be found in very common household items, such as: lamps, tableware, jewelry, crystal glasses, electric cords, beauty products, automobiles, and furniture.

Why Did I Find a Proposition 65 Warning on My Home Goods Product?

We include Proposition 65 warnings on all of our products because there is always a chance that one of the 800-plus common chemicals and ingredients listed under this law could potentially be on our furniture or packing materials. We risk large fines under this law, if we don't include this warning.

Should I worry?

We realize you may be worried finding this warning on our products, but we want to reassure you that the hazardous exposure limits for any of these chemicals have never been found on furniture products that we've shipped to our customers. Additionally, this warning label is very common and can be found on almost every piece of furniture sold in the state of California.

Just How Common Are Proposition 65 Warnings?

Proposition 65 warnings have become so common in California that it is hard to take a trip to a local bank, grocery store, or restaurant without finding at least one warning. In fact, even the Disney Land Resort has a Proposition 65 warning:

