

ASSEMBLY INSTRUCTION

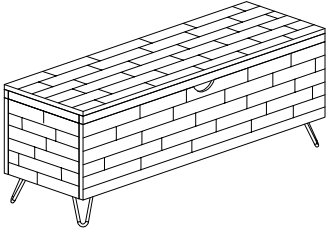

TRUNK



Thank you for purchasing this quality product. Be sure to check all packing material carefully for small parts, which may have come loose inside carton during shipment. Identify and count all parts and compare with the parts list below.

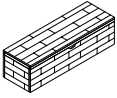

ASSEMBLY INSTRUCTION :

1. Remove hardware from box and sort by size.
2. Please check to see that all hardware and parts are present prior start of assembly.
3. Please follow attached instruction in the same sequence as numbered to assure fast and easy assembly
4. Hand fasten all bolts before tightened with Allen wrench

No.	Component		Q'ty
Ⓐ		Trunk	1
Ⓑ		Leg	4

No.	HARDWARE LIST		Q'ty
①		Bolts M6x20	12
②		Flat washers Ø6x12	12
③		Allen Wrench	1

Step 1

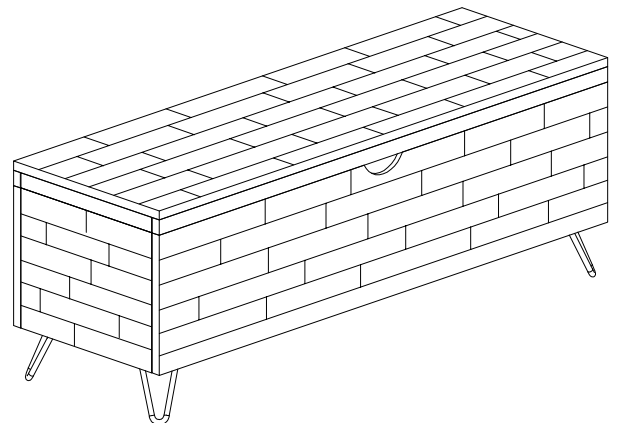
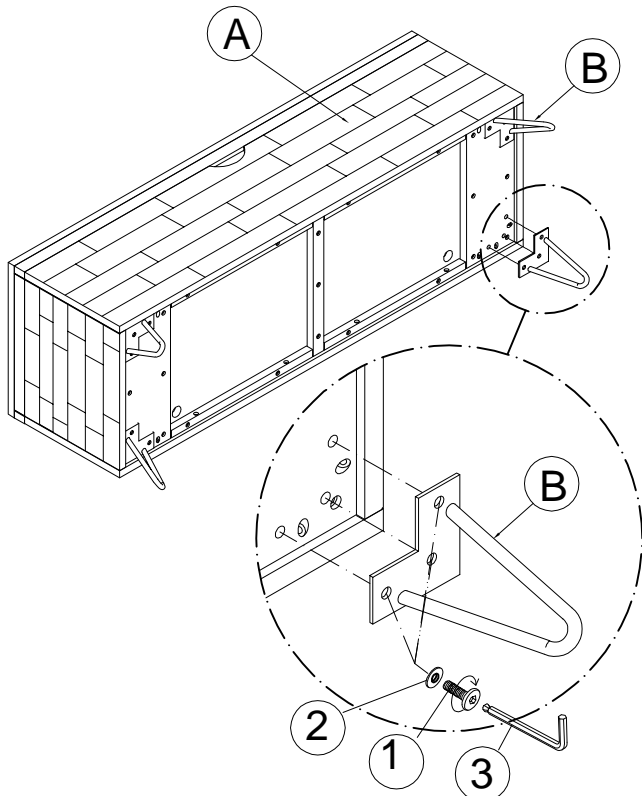

Finish