

# ASSEMBLY INSTRUCTION

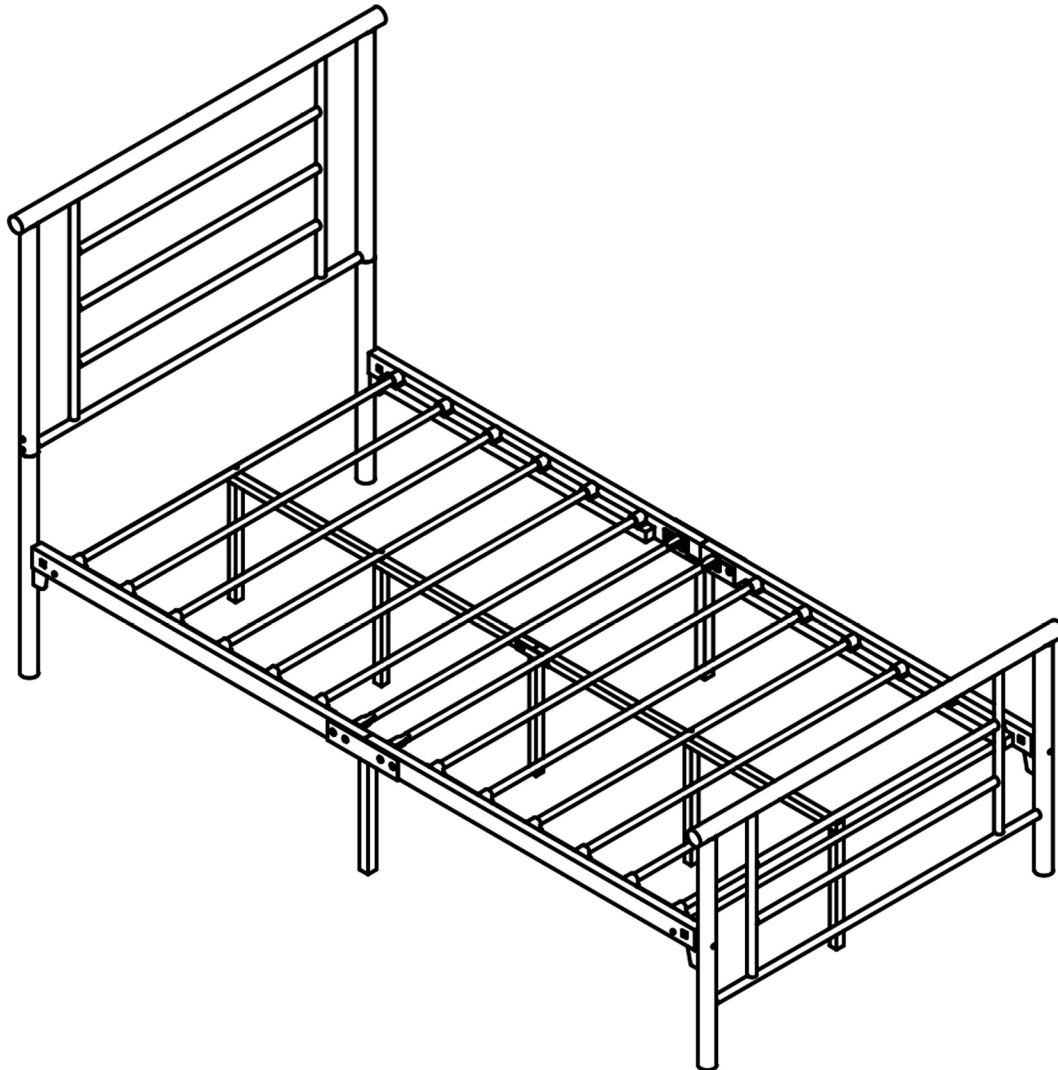

MODEL NUMBER : 633TWIN

## NOTES:











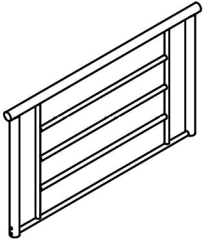
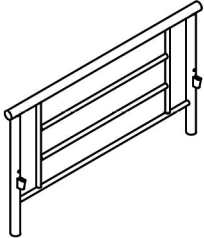
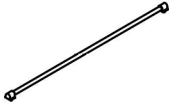
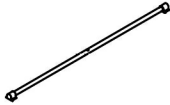

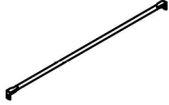
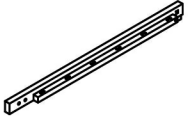
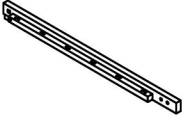

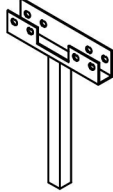





- The item is only intended to be used indoors. The product must be assembled and used in accordance with the provisions of the manual.
- It is recommended that assembly is undertaken by about 2 adults. Please read assembly instructions before assembly and strictly adhere to each step outlined. Estimated assembly time is 30 minutes.

## WARNING:

- **WARNING FOR YOUNG CHILDREN** - This product contains small components, please ensure that they are kept away from small children while assembling.

# 1

# PARTS LIST

A		B		C		D		E		F		G	
													
1PCS		1PCS		8PCS		4PCS		2PCS		2PCS		2PCS	
H		I		J		K		L		M		N	
													
2PCS		2PCS		1PCS		1PCS		2PCS		4PCS		1PCS	
a	b	c	d	e	f	g	h	i	j	k	l	m	
													
1/4*90 4PCS	1/4*60 4PCS	1/4*45 4PCS	1/4*37 2PCS	1/4*26 4PCS	1/4*23 4PCS	1/4*16 4PCS	4PCS	8PCS	1/4 2PCS	2PCS	4PCS	1PCS	

NOTE: PLEASE DO NOT TIGHTEN THE BOLTS UNTIL ALL FIXED

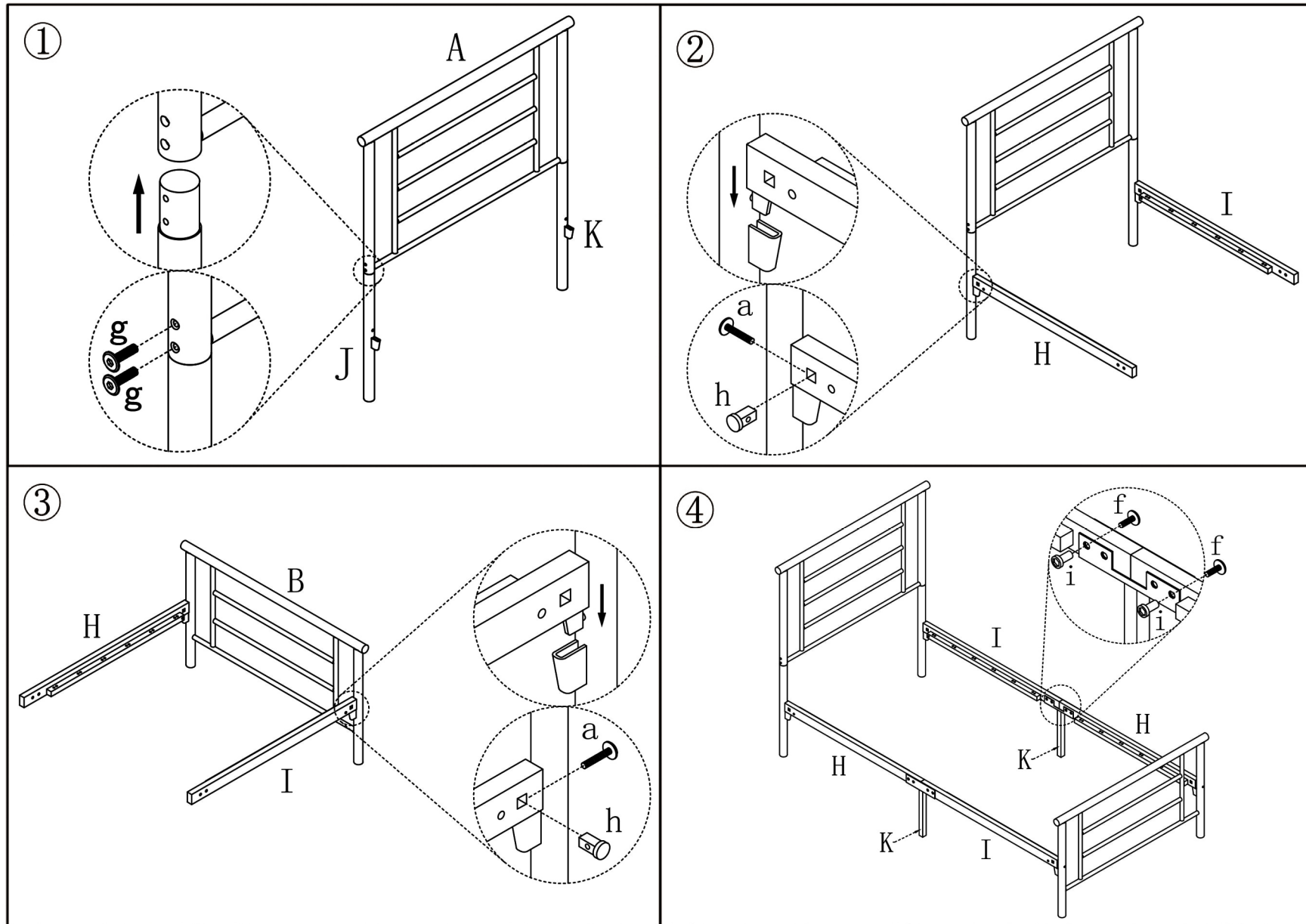

⑤

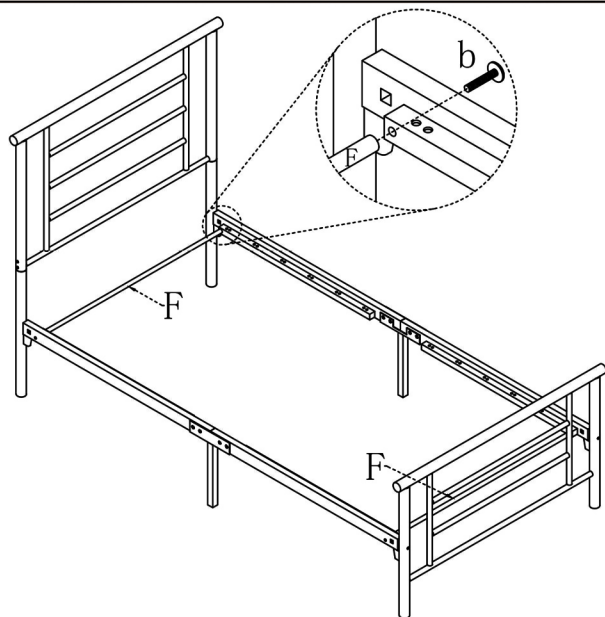

⑥

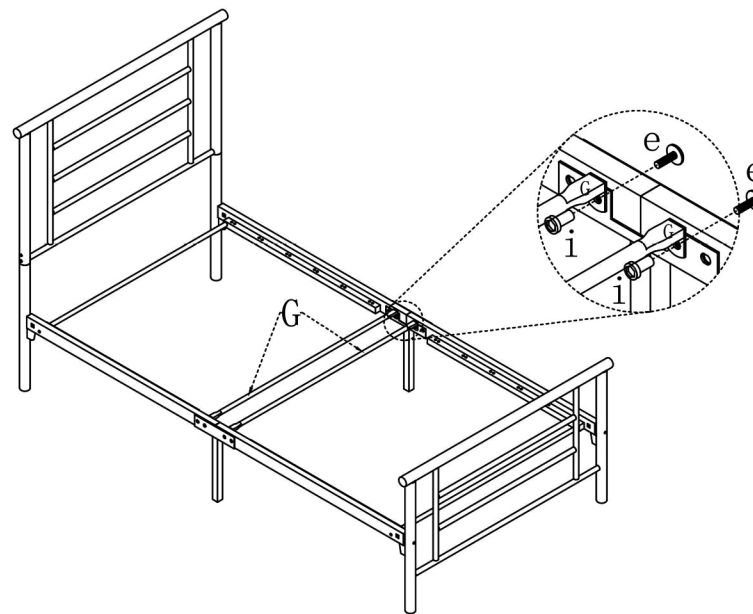

⑦

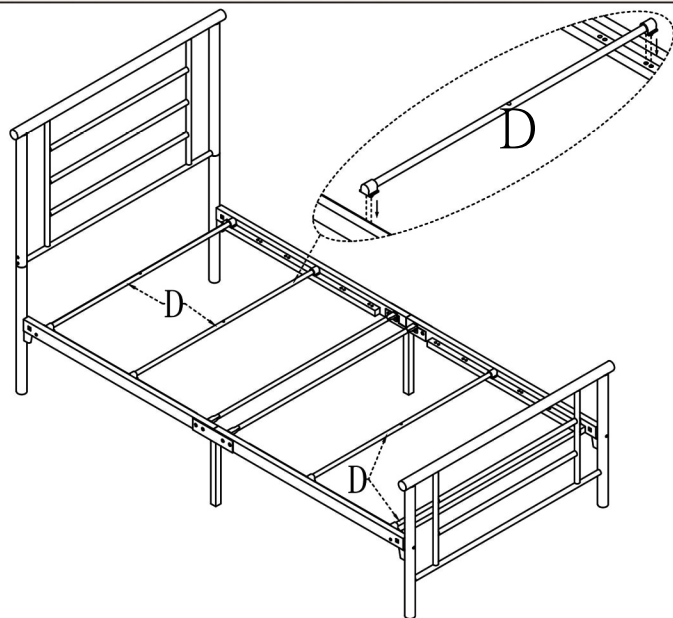

⑧

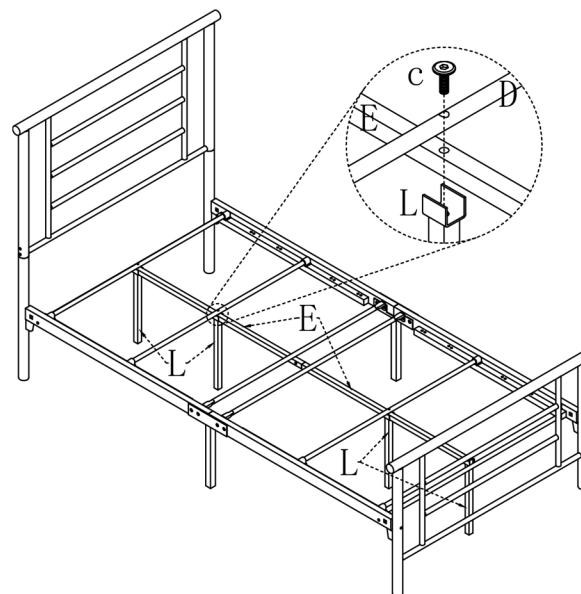

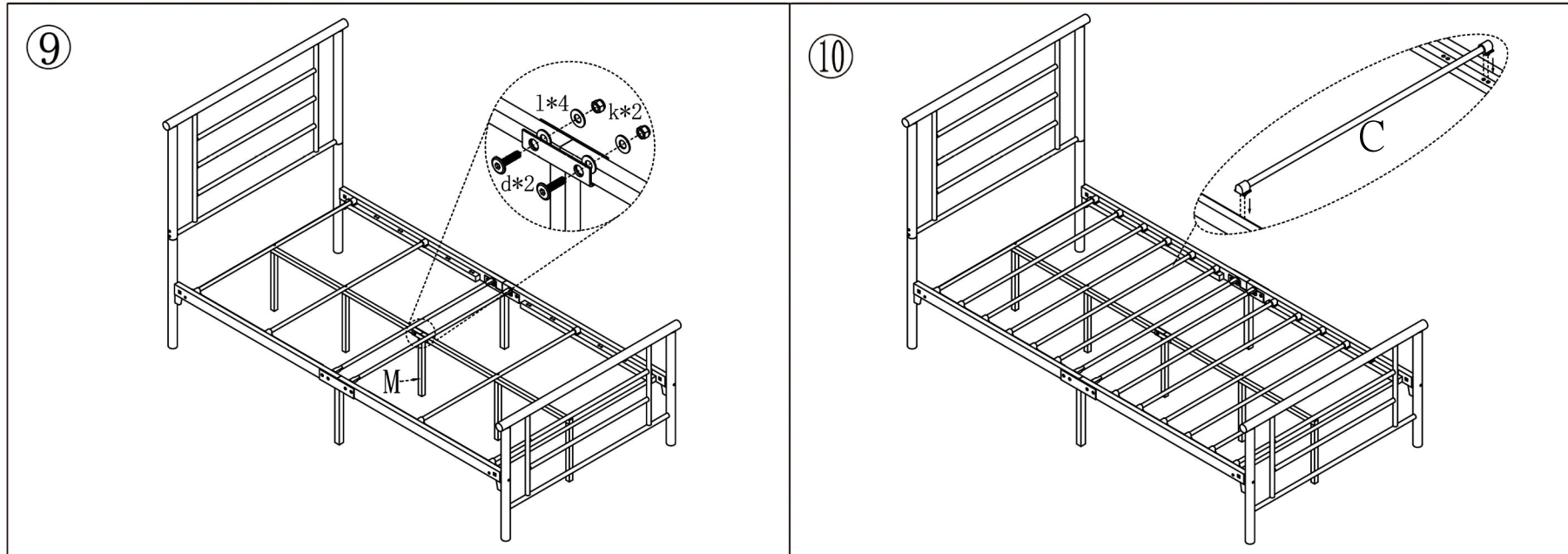

### Warranty Information:

We warranty this product to be free from defects in materials. This warranty covers five years from the date of original purchase.