

WARRANTY

We strive to offer high-quality products, and we also try our best to satisfy each and every customer that orders from us with product or service as needed. We provide 30 days warranty starting from the time you receive the item. Each customer must provide a record of their order such as the order number, or item receipt for any items that are out of the warranty period you may also still receive replacement parts by purchasing them with our company if they are available.

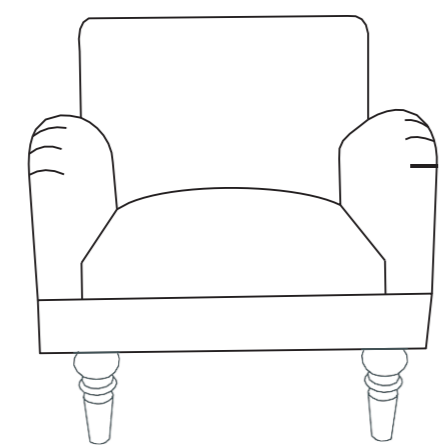

NOTE:

This brochure contains IMPORTANT safety info. Please read and keep for future reference.

8

1

MAINTAINANCE AND WARNING

- Keep furniture away from heat.
- Do not clean furniture with harsh cleansers or polish. Do not use detergents, Solvents, abrasives, spray packs or leather cleaner. Use non-color mild soap with warm water clean spills(Mix 1:10 soap to water)
- Do not place furniture under direct sunlight, material will possibly fade overtime.
- Do not use on site dry Cleaning machine.
- Children should not climb or jump on the furniture.
- Do not write on furniture without a padded barrier to protect the surface.
- Not for commercial use, For residential use only.



Weight Limitation
250LBS

2

PARTS LIST

A*1

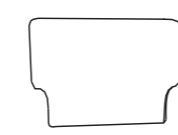

B*2

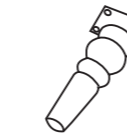

C*1



D*1



E*1

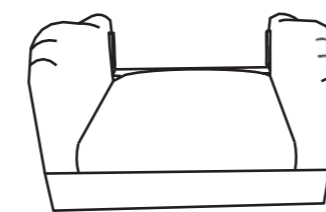

3

HARDWARE LIST

F * 14

M6*25mm



G*1



SPARE

F*1



Be sure to check all packing material carefully for small parts, which may have come loose inside the carton during shipment.

4

ASSEMBLY INSTRUCTIONS

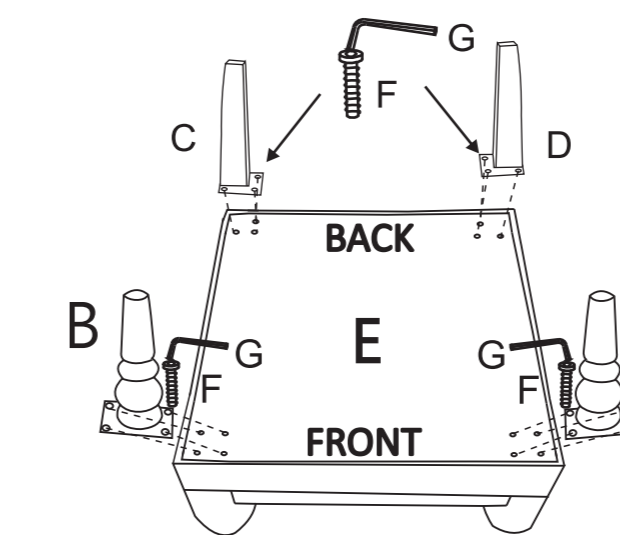
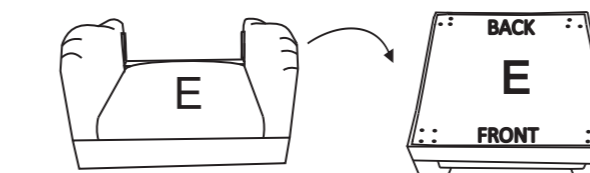

STEP 1: Place seat E upside down on clean padded surface. Use bolt F, allen key G to attach legs B/C/D to bottom of the seat E, make sure all parts align then fasten all bolts to secure.

5

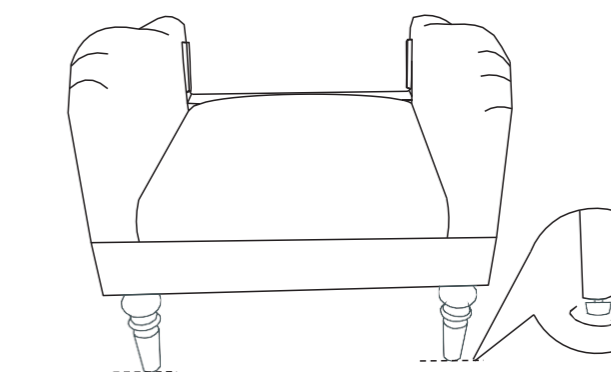

STEP 2: Align male and female metal bracket then insert backrest A and push it all the way down to secure.

6

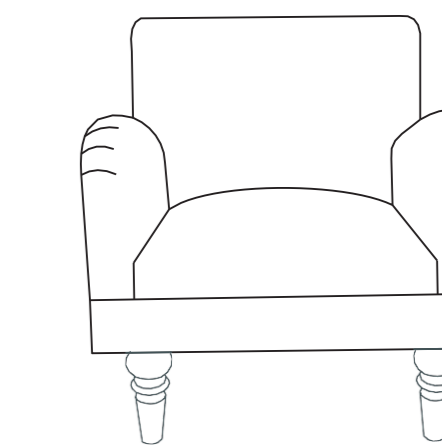

STEP 3: Assembly completed

7