

ASSEMBLY INSTRUCTION

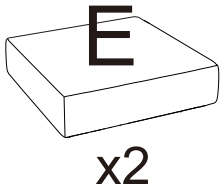

PARTS LIST

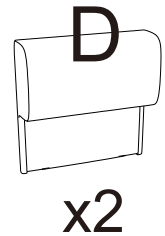
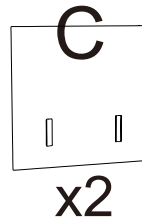
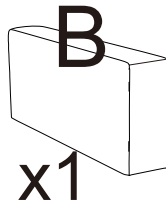
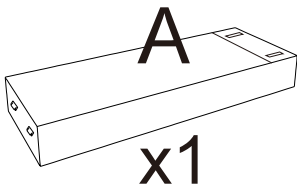

BEFORE ASSEMBLY

Open up of Non-Woven Fabric cover on the bottom to remove hardware, legs and parts.

1. Please open the black woven fabric with Velcro closure on the bottom of the frame then cut off the black straps before removing the parts for assembly.

2. After removing the cushion from the compress bag, please allow air to flow through the cushion for few days. You can try to fluff cushion by push in and push out on all four sides of the cushion. Hitting the top/front of the cushion with your hand to fluff them after installation.

3. Please allow at least 24 hours for the cushions to recover to its natural state after removing from the package.

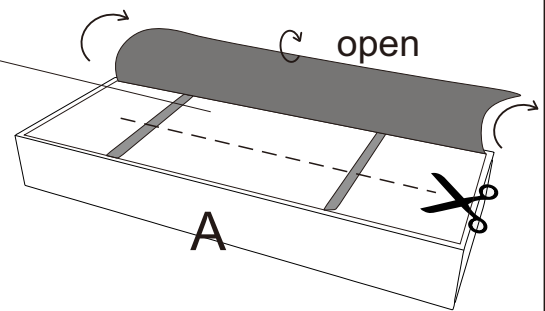
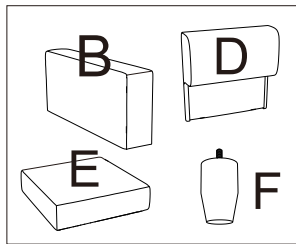

Step1

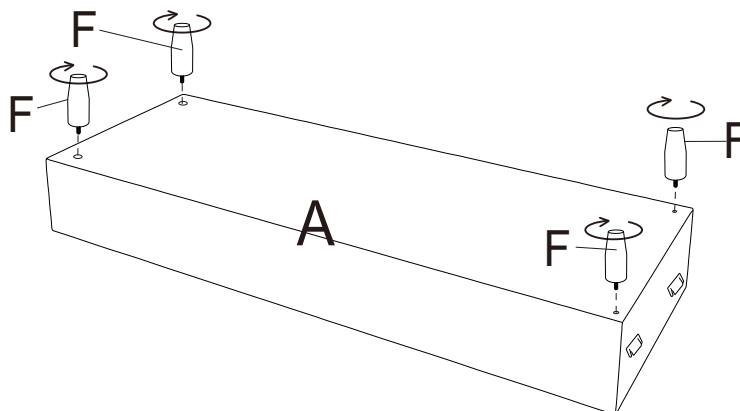

ASSEMBLY INSTRUCTION

Step2

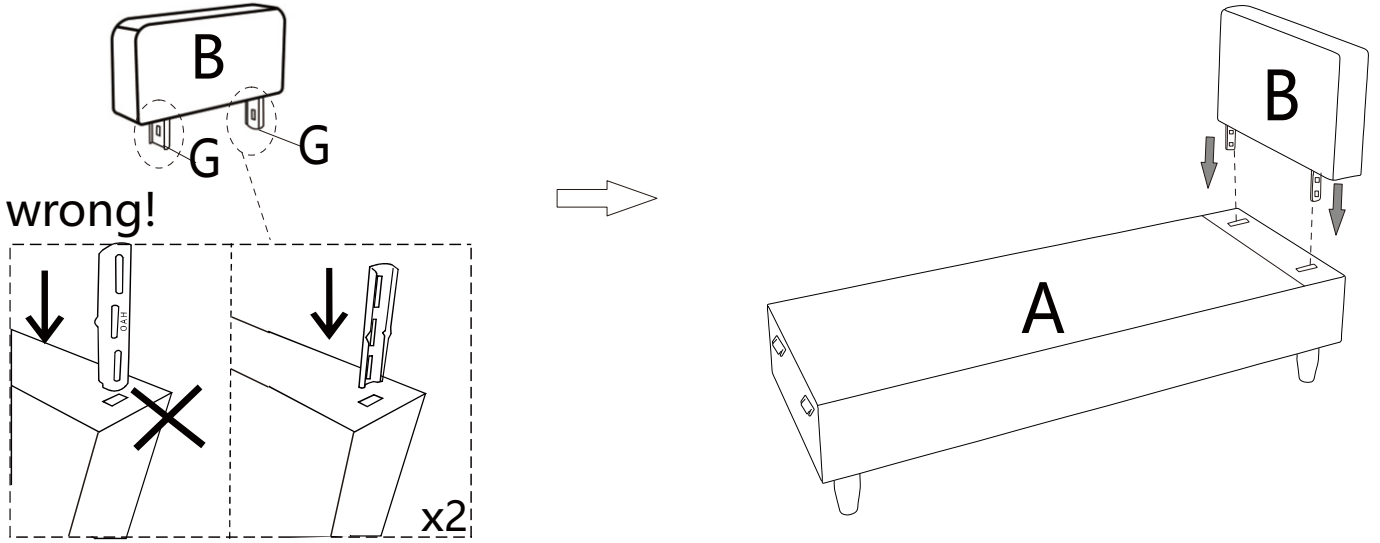

Step3

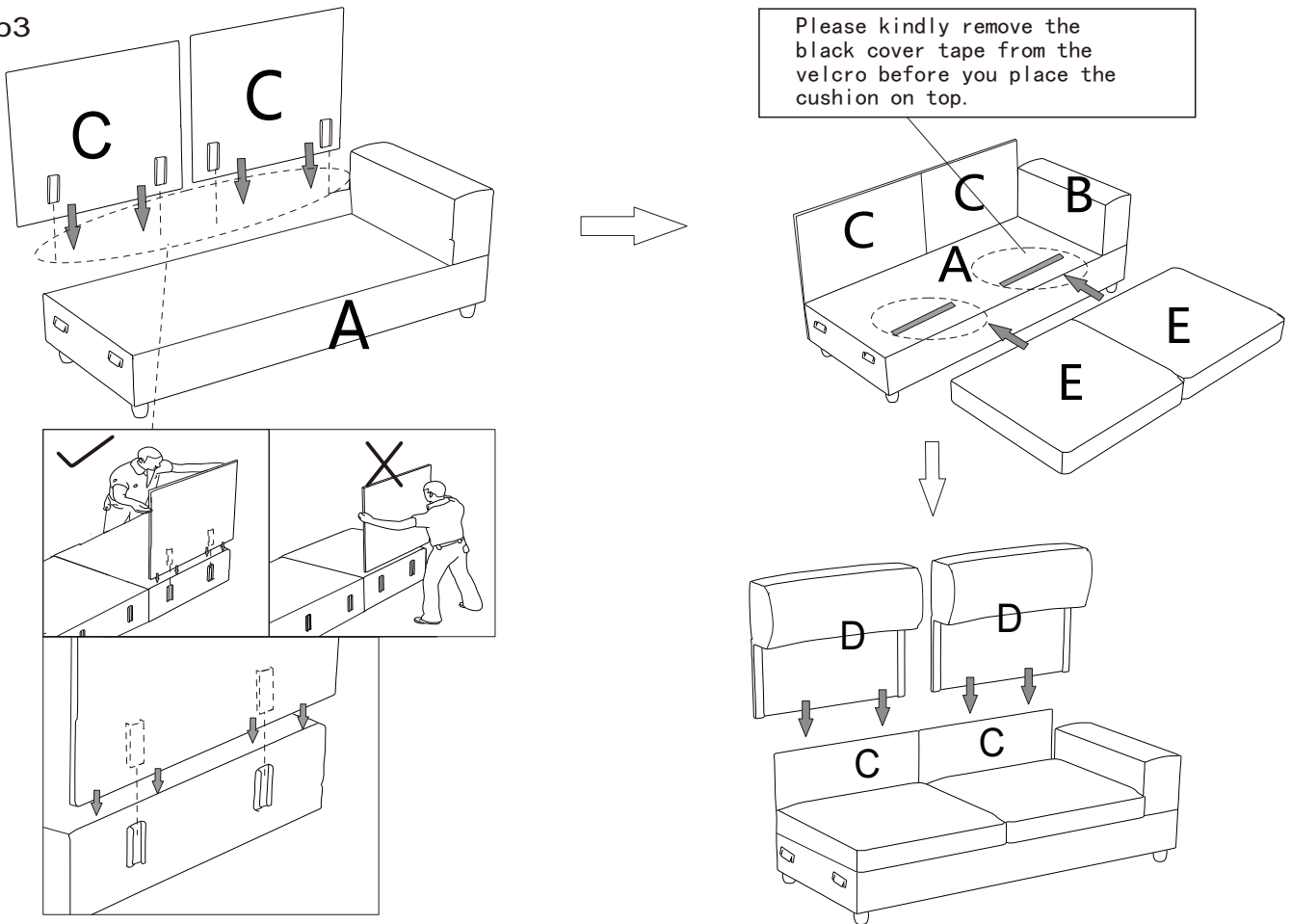

Step4

