



**INSTRUCTIONS D'ASSEMBLAGE  
ASSEMBLY INSTRUCTIONS**

---

**LIT -  
SIMPLE / BORDURE EN ARGENT TISSUS GRIS**

**BED -  
TWIN SIZE / GREY LINEN WITH CHROME TRIM**



**POUR DE L'ASSISTANCE OU POUR COMMANDER  
DES PIÈCES CONTACTEZ NOTRE DÉPARTEMENT  
DE SERVICE À LA CLIENTÈLE.**

**FOR ASSISTANCE OR TO ORDER PARTS  
CONTACT OUR CUSTOMER SERVICE DEPARTMENT**

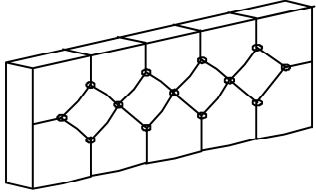
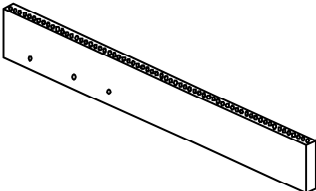
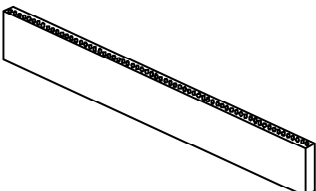
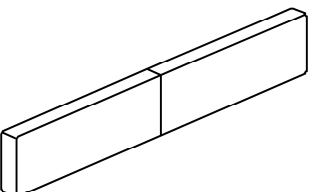
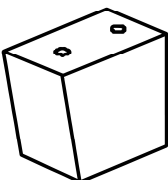

## LISTE DES PIÈCES PARTS LIST

PIÈCE / PART #	IMAGE	DESCRIPTION	QTY / QTÉ
<b>1</b>		<b>HEADBOARD TÊTE DE LIT</b>	<b>1</b>
<b>2</b>		<b>FRONT FACING HEADBOARD RIGHT LEG TÊTE DE LIT AVANT DROITE</b>	<b>1</b>
<b>3</b>		<b>FRONT FACING HEADBOARD LEFT LEG TÊTE DE LIT AVANT GAUCHE</b>	<b>1</b>
<b>4</b>		<b>FOOTBOARD PIED DE LIT</b>	<b>1</b>
<b>5</b>		<b>FRONT FACING FOOTBOARD RIGHT LEG PIED DE LIT AVANT DROIT</b>	<b>1</b>

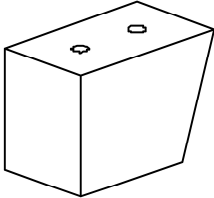
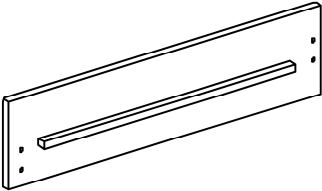
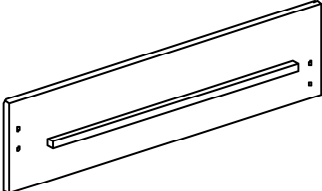
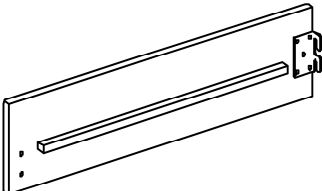
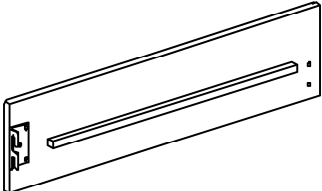

## LISTE DES PIÈCES PARTS LIST

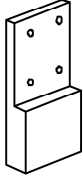
PIÈCE / PART #	IMAGE	DESCRIPTION	QTY / QTÉ
<b>6</b>		<b>FRONT FACING FOOTBOARD LEFT LEG PIED DE LIT AVANT GAUCHE</b>	<b>1</b>
<b>7</b>		<b>FRONT FACING LEFT SIDE RAIL RAIL DE CÔTÉ GAUCHE</b>	<b>1</b>
<b>8</b>		<b>FRONT FACING RIGHT SIDE RAIL RAIL DE CÔTÉ DROIT</b>	<b>1</b>
<b>9</b>		<b>FRONT FACING LEFT SIDE RAIL RAIL DE CÔTÉ GAUCHE</b>	<b>1</b>
<b>10</b>		<b>FRONT FACING RIGHT SIDE RAIL RAIL DE CÔTÉ DROIT</b>	<b>1</b>

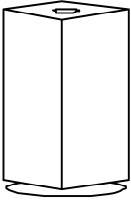
## LISTE DES PIÈCES PARTS LIST

PIÈCE / PART #	IMAGE	DESCRIPTION	QTY / QTÉ
<b>11</b>		SIDE RAIL SUPPORT LEG RAIL DE CÔTÉ PATTE DE SOUTIENT	<b>2</b>
<b>12</b>		SLAT LAMELLE	<b>4</b>
<b>13</b>		SUPPORT LEG PATTE DE SOUTIEN	<b>4</b>

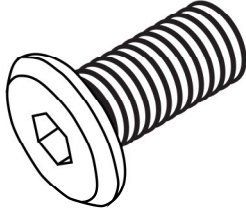
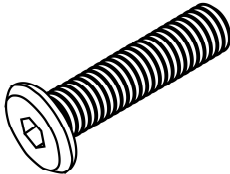
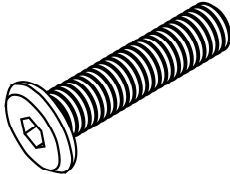
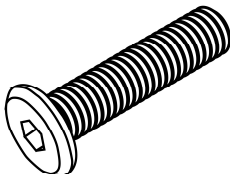
## LISTE DES PIÈCES DE MONTAGE HARDWARE LIST

PIÈCE / PART #	IMAGE	DESCRIPTION	QTY / QTÉ
<b>A</b>		<b>ASSEMBLING BOLT - Ø 5/16" X 3/4"</b> <b>BOULON D'ASSEMBLAGE - Ø 5/16" X 3/4"</b>	<b>4</b>
<b>B</b>		<b>ASSEMBLING BOLT - Ø 1/4" X 1"</b> <b>BOULON D'ASSEMBLAGE - Ø 1/4" X 1"</b>	<b>8</b>
<b>C</b>		<b>ASSEMBLING BOLT - Ø 1/4" X 1 3/8"</b> <b>BOULON D'ASSEMBLAGE - Ø 1/4" X 1 3/8"</b>	<b>10</b>
<b>D</b>		<b>ASSEMBLING BOLT - Ø 5/16" X 2"</b> <b>BOULON D'ASSEMBLAGE - Ø 5/16" X 2"</b>	<b>4</b>
<b>E</b>		<b>ASSEMBLING BOLT - Ø 1/4" X 2 3/4"</b> <b>BOULON D'ASSEMBLAGE - Ø 1/4" X 2 3/4"</b>	<b>2</b>

## LISTE DES PIÈCES DE MONTAGE HARDWARE LIST

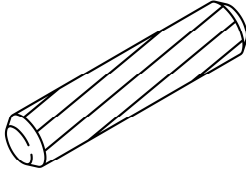
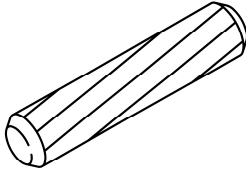
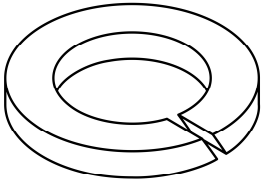
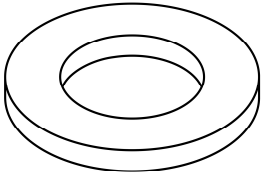
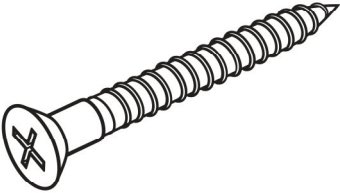
PIÈCE / PART #	IMAGE	DESCRIPTION	QTY / QTÉ
<b>F</b>		WOOD DOWEL Ø 5/16" X 1 3/16"	2
<b>G</b>		WOOD DOWEL Ø 3/8" X 1 3/16"	4
<b>H</b>		LOCK WASHER - M6 ENTRETOISE DE MÉTAL - M6	14
<b>I</b>		METAL WASHER - M6 RONDELLE DE MÉTAL - M6	14
<b>J</b>		ASSEMBLING SCREW - Ø 1/8" X 1 1/4" VIS D'ASSEMBLAGE - Ø 1/8" X 1 1/4"	8

**LISTE DES PIÈCES DE MONTAGE**  
**HARDWARE LIST**

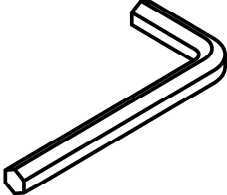
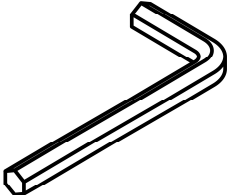
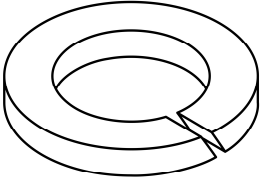
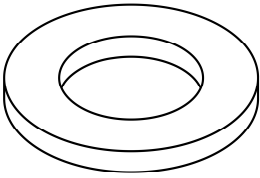
PIÈCE / PART #	IMAGE	DESCRIPTION	QTY / QTÉ
<b>K</b>		<b>HEX KEY -</b> <b>M5 X 2 9/16"</b> <b>CLÉ HEXAGONALE -</b> <b>M5 X 2 9/16"</b>	<b>1</b>
<b>L</b>		<b>HEX KEY -</b> <b>M4 X 2 9/16"</b> <b>CLÉ HEXAGONALE -</b> <b>M4 X 2 9/16"</b>	<b>1</b>
<b>M</b>		<b>LOCK WASHER -</b> <b>M8</b> <b>ENTRETOISE DE MÉTAL -</b> <b>M8</b>	<b>4</b>
<b>N</b>		<b>METAL WASHER -</b> <b>M8</b> <b>RONDELLE DE MÉTAL -</b> <b>M8</b>	<b>4</b>



**OUTIL DE VÉRIFICATION DE DIMENSIONS DES PIÈCES  
HARDWARE DIMENSIONS VERIFICATION TOOL**



ÉTAPE / STEP 1

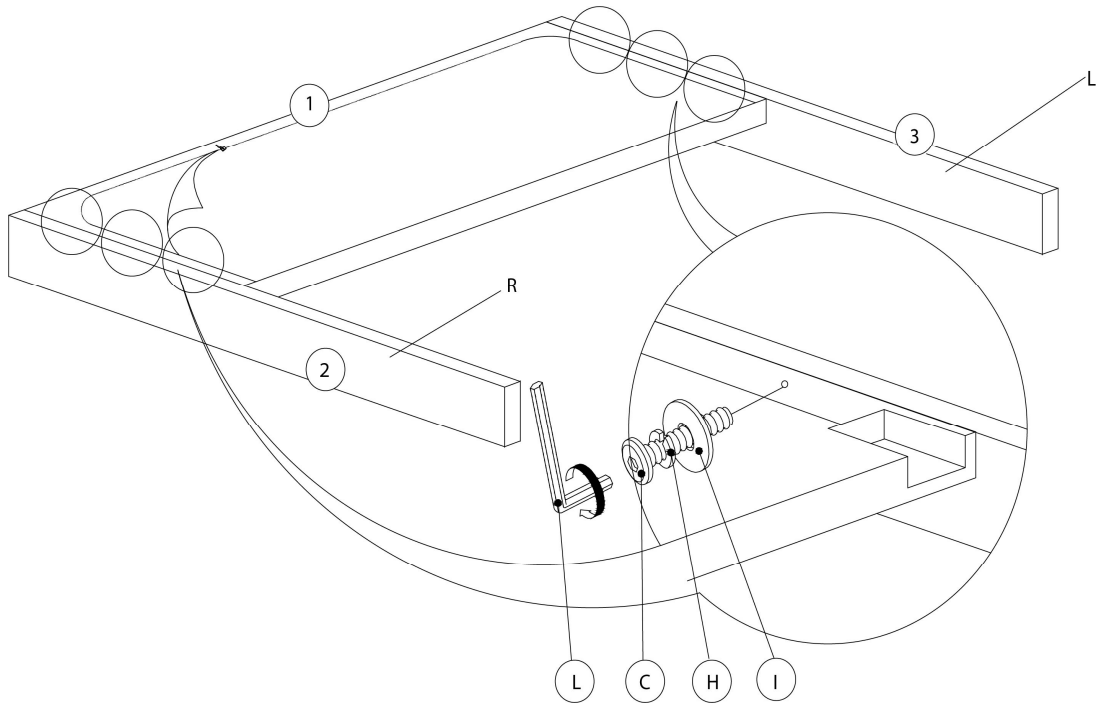

ÉTAPE / STEP 2

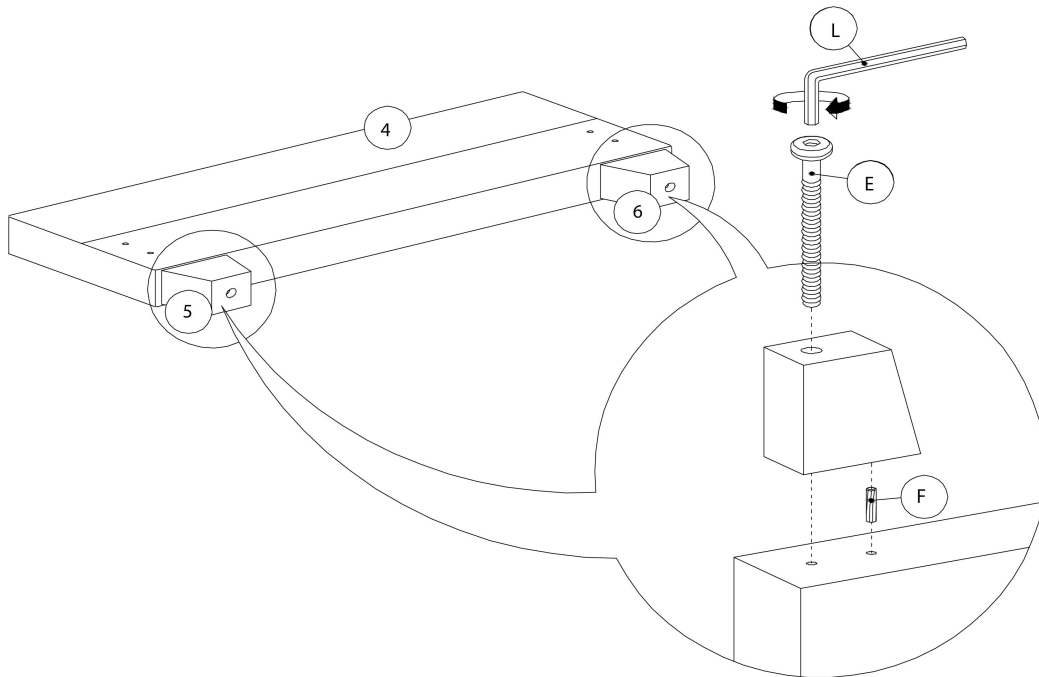

ÉTAPE / STEP 3

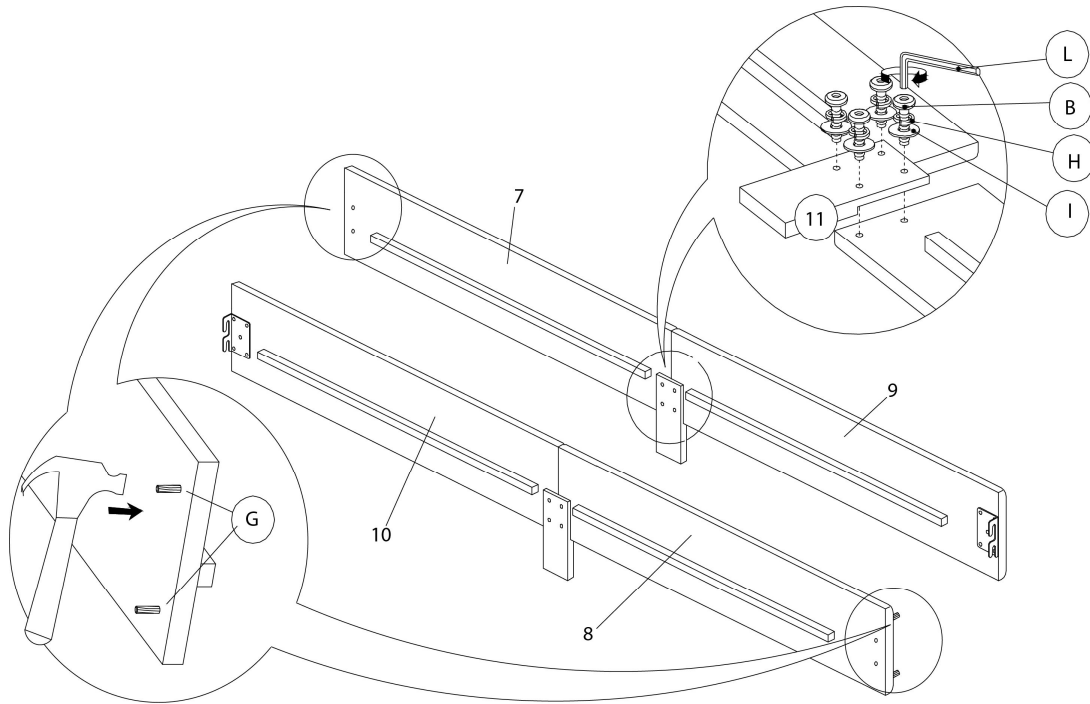

ÉTAPE / STEP 4

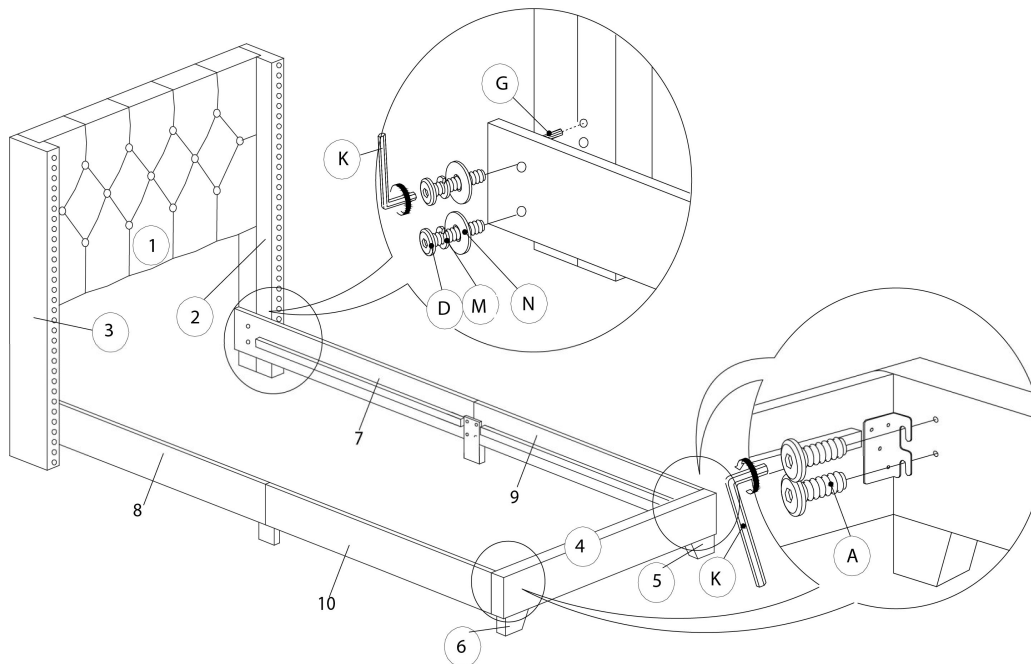

ÉTAPE / STEP 5

