



ASSEMBLY INSTRUCTION MODULAR CHAIR W/REMOVABLE PILLOW & BOLSTER

NOTE: Please identify and locate all assembly parts (see parts list) before discarding any packing materials. Some parts may have become loose during transit.

COMPONENT LIST

NO.	DRAWING	QTY	DESCRIPTION
A		1	PILLOW
B		1	BOLSTER
C		4	PLASTIC LEG
D		1	SEAT

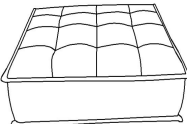
STEP# 1

Parts are stored inside the bottom of the seat. Please take out for assembly.

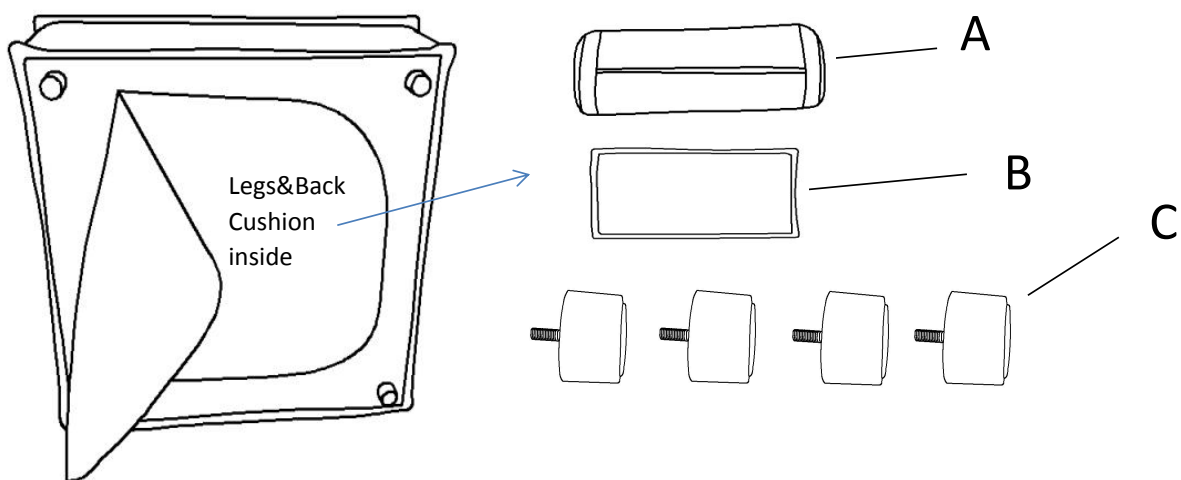

STEP# 2

Zip the pillow and bolster as follow.

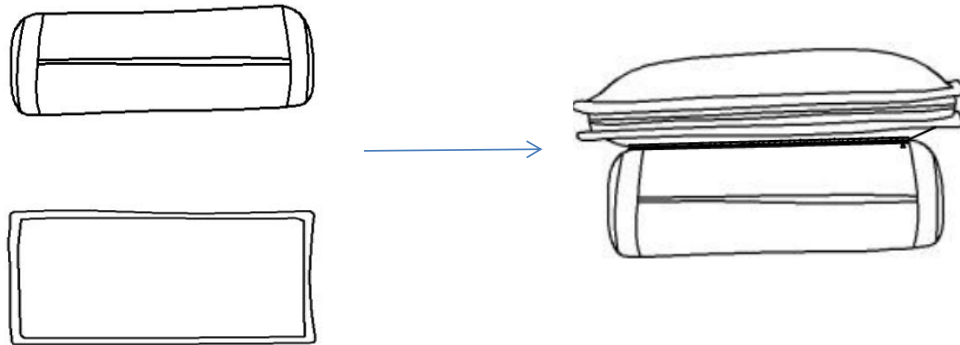

STEP# 3

Place bolster and pillow on seat and fix properly.

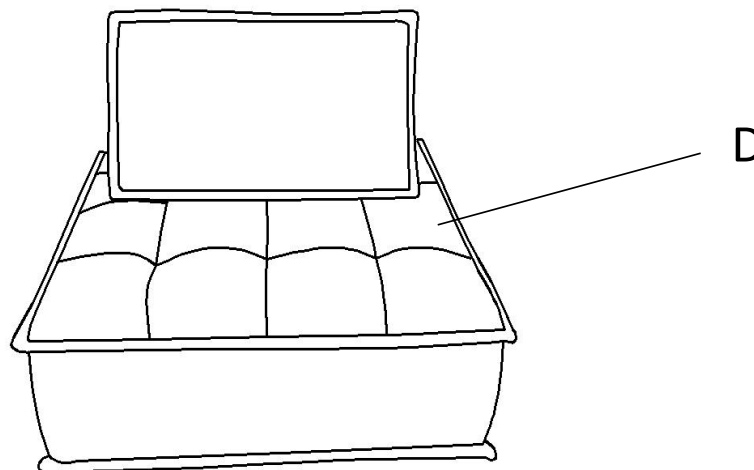

Care Instruction for 100% Polyester Furniture.

In order to maintain the original appearance of your 100% Polyester match furniture, please follow below simple care procedures:

- Avoid exposing furniture directly to sunlight or heating and air conditioning outlets. Sunlight and/or exposure to heating and air conditioning outlets will fade/damage 100% Polyester. Do not place your 100% Polyester furniture too close to windows, radiators, or vents.
- Vacuum or wipe with a soft brush to remove dust.
- Do not pull out hang tag. Use scissors to cut off the plastic string to remove the tag.



For items use on wooden floor, hard surfaces or carpets, it is recommended to Install protective pads under all legs and supports to avoid/prevent from damages/scratches and discoloration.