

5/8" DRAPERY ROD INSTALLATION INSTRUCTIONS - 26-48" ROD SET

Care Instructions: Clean with a soft cloth. Do not use abrasive cleaning agents, solvents or polishes.

SET INCLUDES:

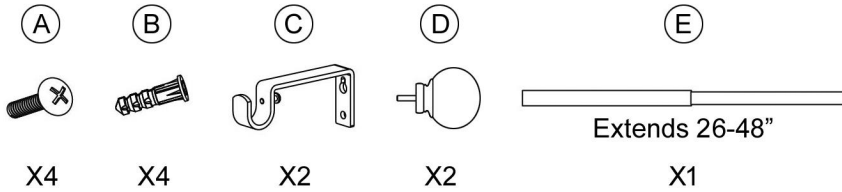

YOU WILL NEED:

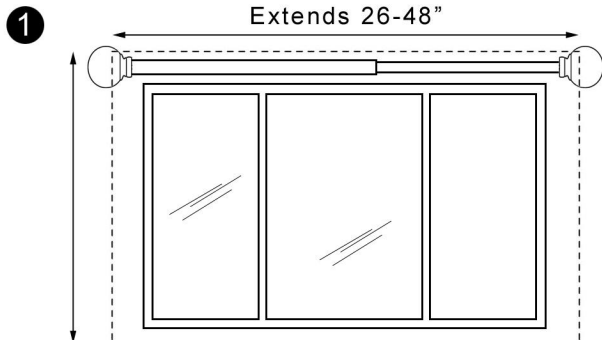
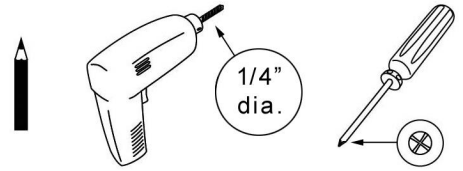

Before installation, measure windows to determine appropriate drapery rod length.

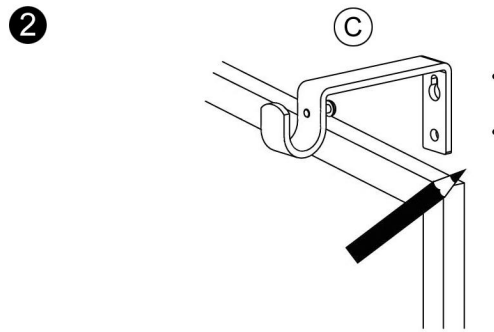

Use bracket (C) as a guide to mark location for mounting screws (A).

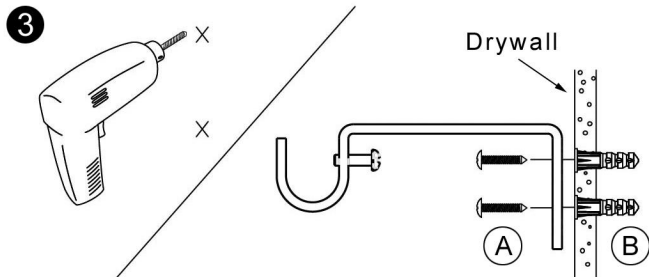

Drill pilot holes into wall with 1/4" drill bit (not included). Insert wall anchors (B) and attach bracket (C) using mounting screws (A). Wall anchors may not be necessary if drilling into studs.

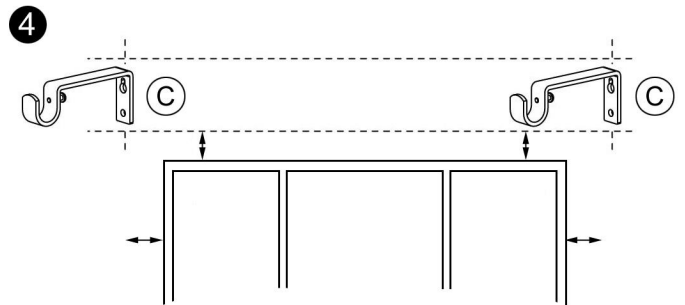

Repeat steps 2-3 for additional bracket. Use level if necessary.

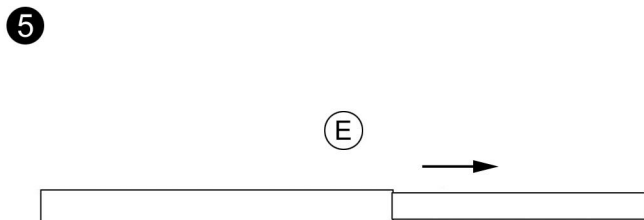

Extend telescoping rod (E) slightly.

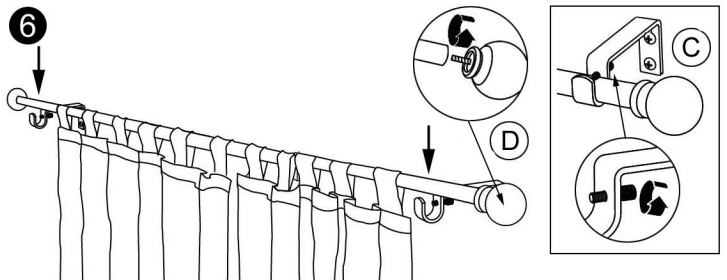

Place drapery panels (not included) onto drapery rod and extend to desired length. Hang rod on brackets. Screw finials (D) onto ends of rod and tighten set screws on brackets (C).