

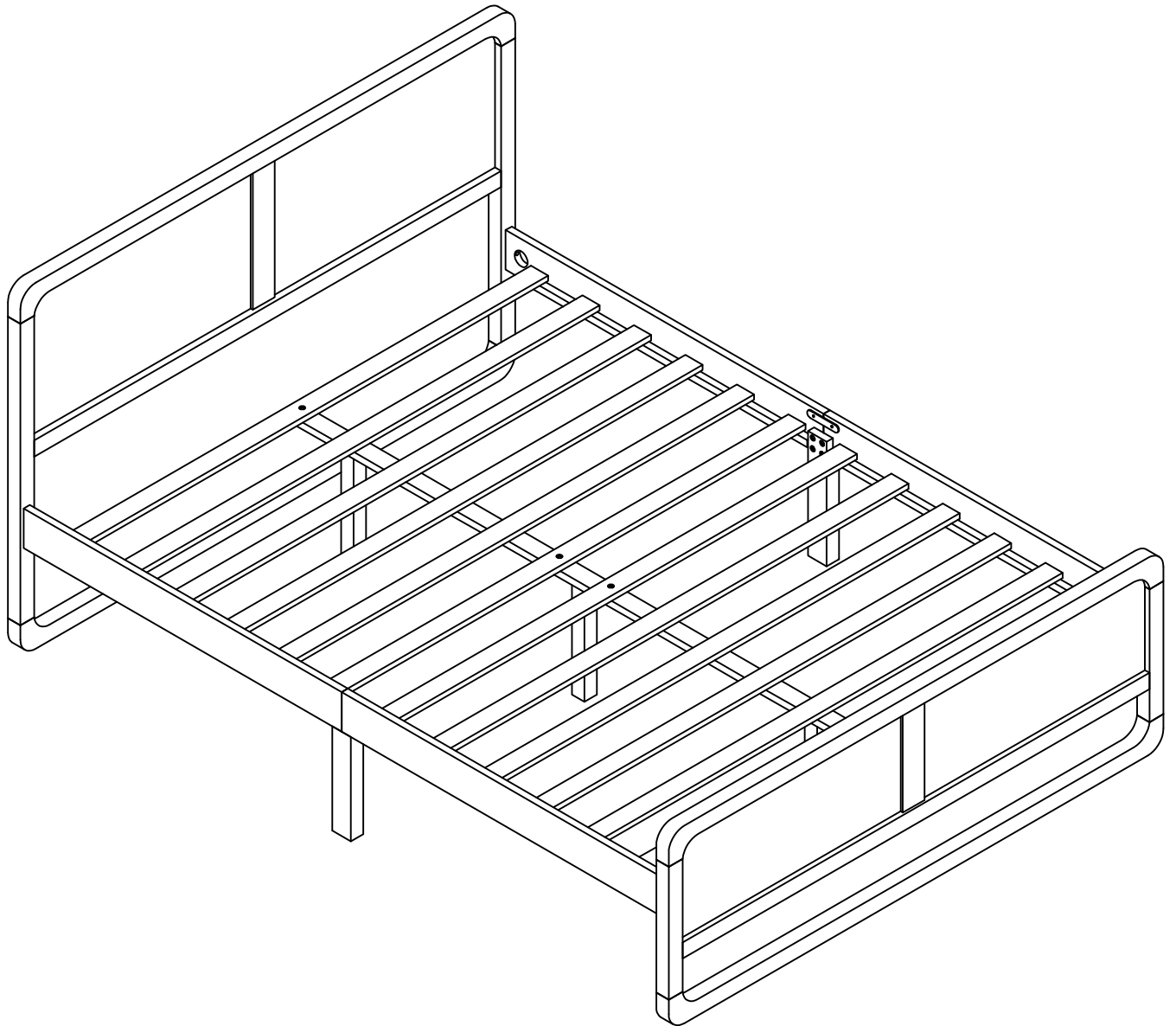

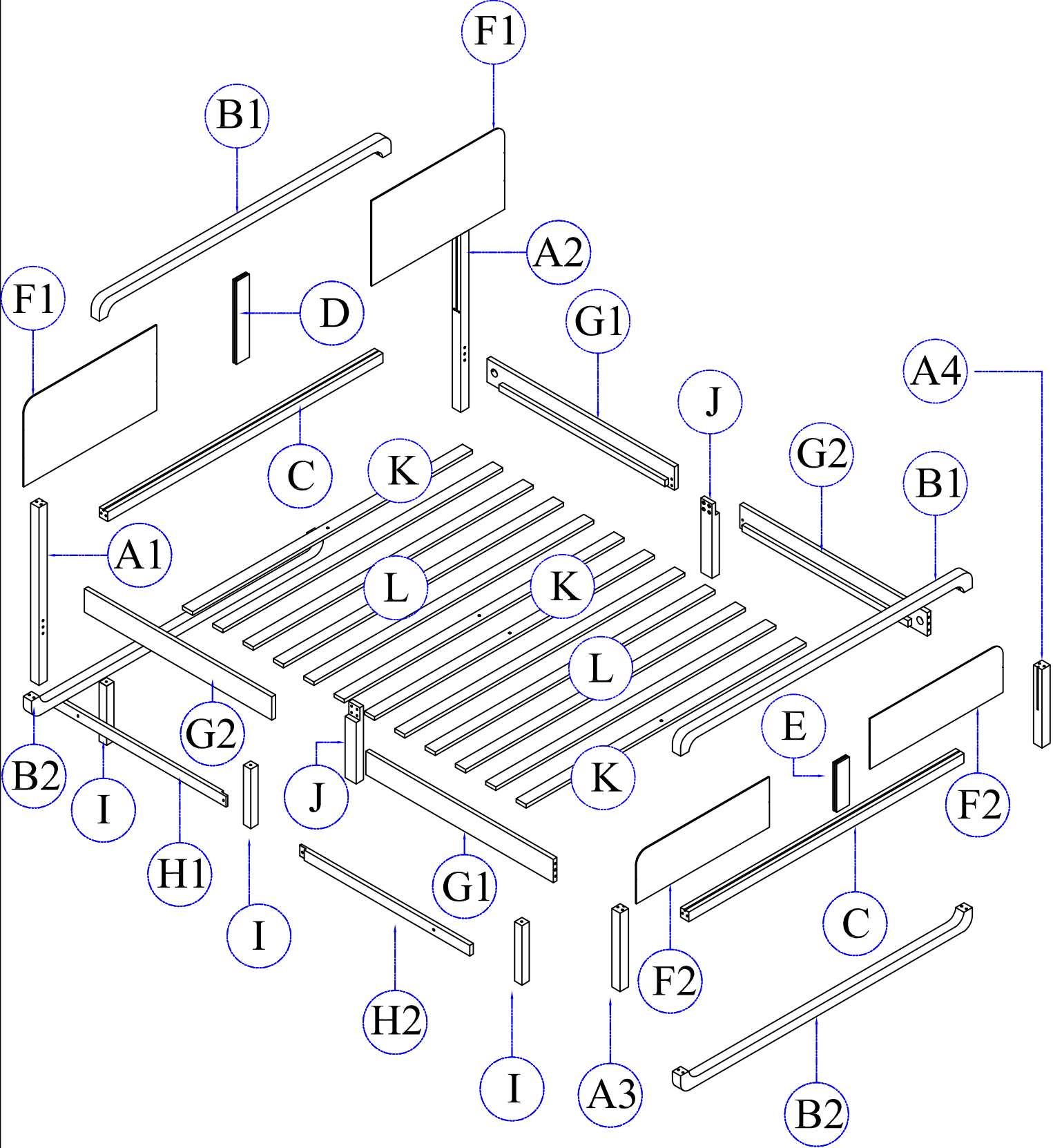

Assembly Instructions





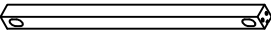
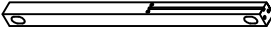
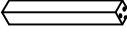
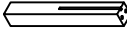
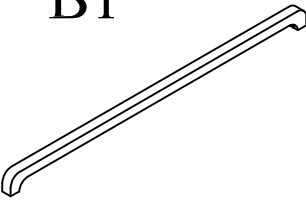
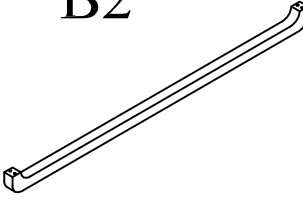
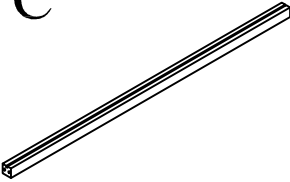

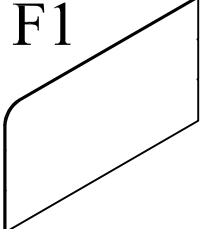
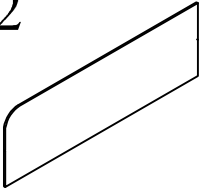

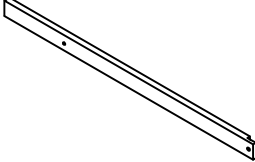
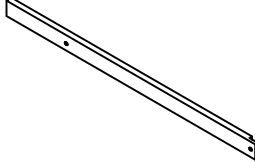
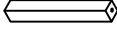
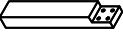
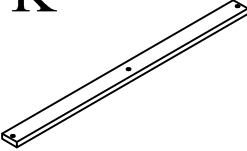
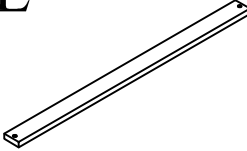

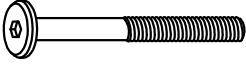
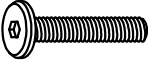
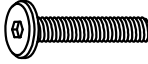

DETAIL VIEW

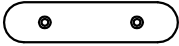
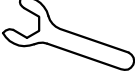

BOX :

| | | | |
|---|--|--|--|
| <p>A1</p>  <p>Headboard post (L) (1 pc)</p> | <p>A2</p>  <p>Headboard post (R) (1 pc)</p> | <p>A3</p>  <p>Footboard post (L) (1 pc)</p> | <p>A4</p>  <p>Footboard post (R) (1 pc)</p> |
| <p>B1</p>  <p>Top slat (2 pcs)</p> | <p>B2</p>  <p>Bottom slat (2 pcs)</p> | <p>C</p>  <p>Middle slat (2 pcs)</p> | <p>D</p>  <p>Headboard Center bar (1 pc)</p> |
| <p>E</p>  <p>Footboard Center bar (1 pc)</p> | <p>F1</p>  <p>Headboard panel (2 pcs)</p> | <p>F2</p>  <p>Footboard panel (2 pcs)</p> | <p>G1</p>  <p>Side Rail (2 pcs)</p> |
| <p>G2</p>  <p>Side Rail (2 pcs)</p> | <p>H1</p>  <p>Center slat (1 pc)</p> | <p>H2</p>  <p>Center slat (1 pc)</p> | <p>I</p>  <p>Support post (3 pcs)</p> |
| <p>J</p>  <p>Support post side rail (2 pcs)</p> | <p>K</p>  <p>Slat with one center hole (4 pcs)</p> | | <p>L</p>  <p>Slats no center hole (8 pcs)</p> |
| | | | |

HARDWARE LIST :

| | | | |
|---|--|---|---|
| <p>1</p>  <p>Hex - Head bolts Ø1/4" * 40 - 12pcs</p> | <p>2</p>  <p>Hex - Head bolts Ø1/4" * 30 - 8pcs</p> | <p>3</p>  <p>Hex - Head bolts Ø1/4" * 65 - 3pcs</p> | <p>4</p>  <p>Wood dowel Ø8 * 30 - 12pcs</p> |
| <p>5</p>  <p>Wood dowel Ø10 * 40 - 8pcs</p> | <p>6</p>  <p>Adjusting screw Ø1/4" * 30 - 3 pcs</p> | <p>7</p>  <p>Allen key M4*100 - 1pc</p> | <p>8</p>  <p>Wood crews M3.5 * 15 - 4pcs</p> |
| <p>9</p>  <p>Wood crews M4 * 30 - 28pcs</p> | <p>10</p>  <p>Connecting Metal=2 pcs</p> | <p>11</p>  <p>Wrench Metal =1 pc</p> | <p>12</p>  <p>Stud bolt Ø5/16" * 75 - 4pcs</p> |
| <p>13</p>  <p>connecting rod -4 pcs</p> | <p>14</p>  <p>Hexanon nut =4 pcs</p> | | |

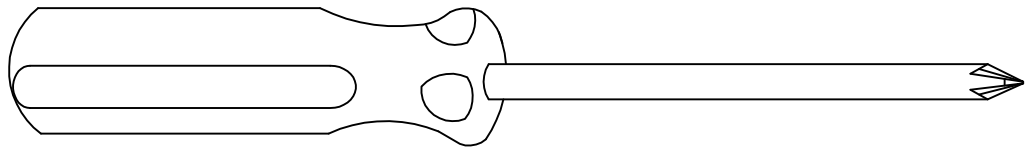

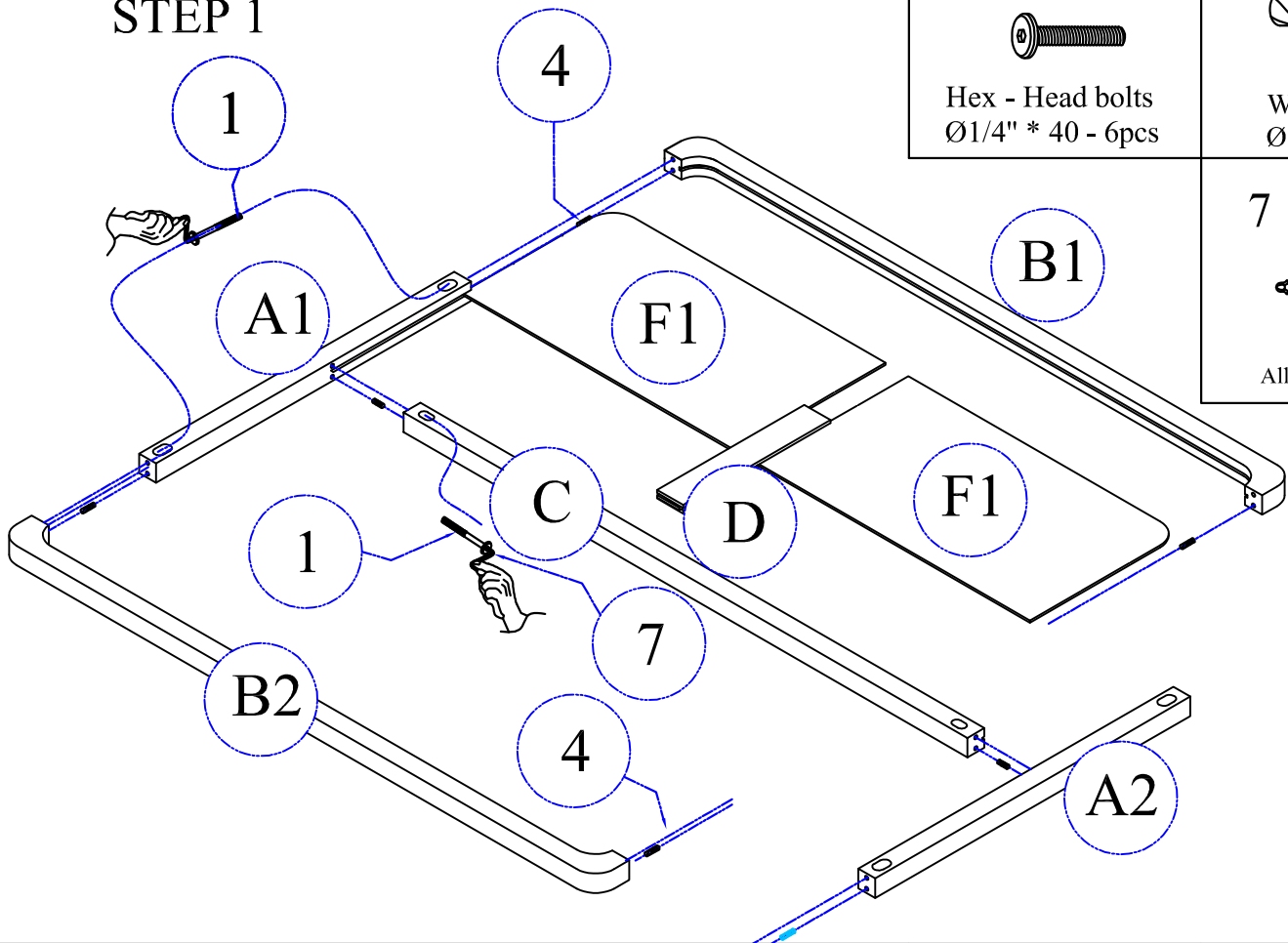

Assembly Tools Required (Not Included)

STEP 1

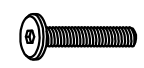

1

 Hex - Head bolts
 Ø1/4" * 40 - 6pcs

4

 Wood dowel
 Ø8 * 30 - 6pcs

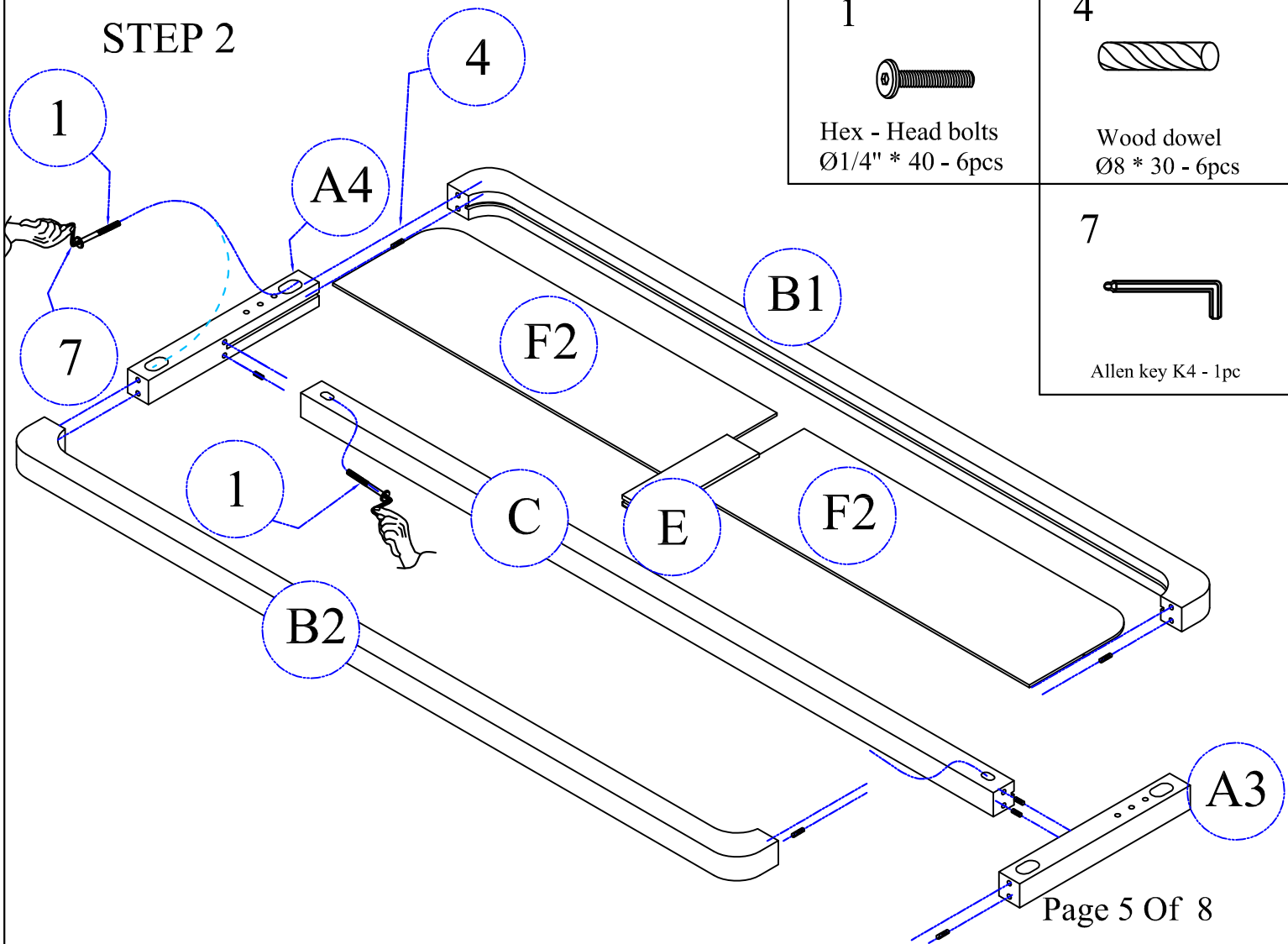
7

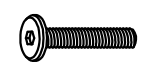
 Allen key K4 - 1pc

STEP 2





1

 Hex - Head bolts
 Ø1/4" * 40 - 6pcs

4

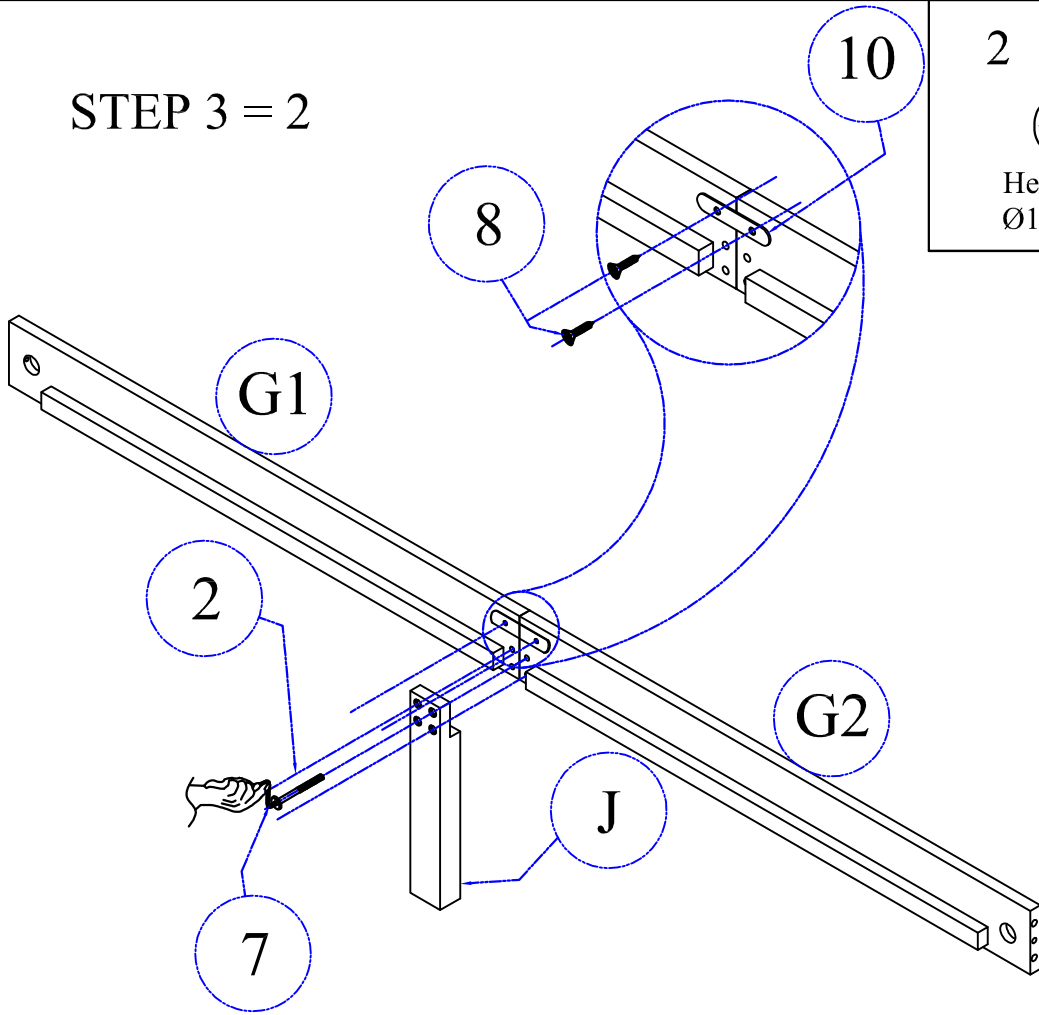
 Wood dowel
 Ø8 * 30 - 6pcs

7

 Allen key K4 - 1pc

STEP 3 = 2



2

 Hex - Head bolts
 Ø1/4" * 30 - 4pcs

7

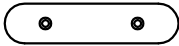
 Allen key K4 - 1pc

8

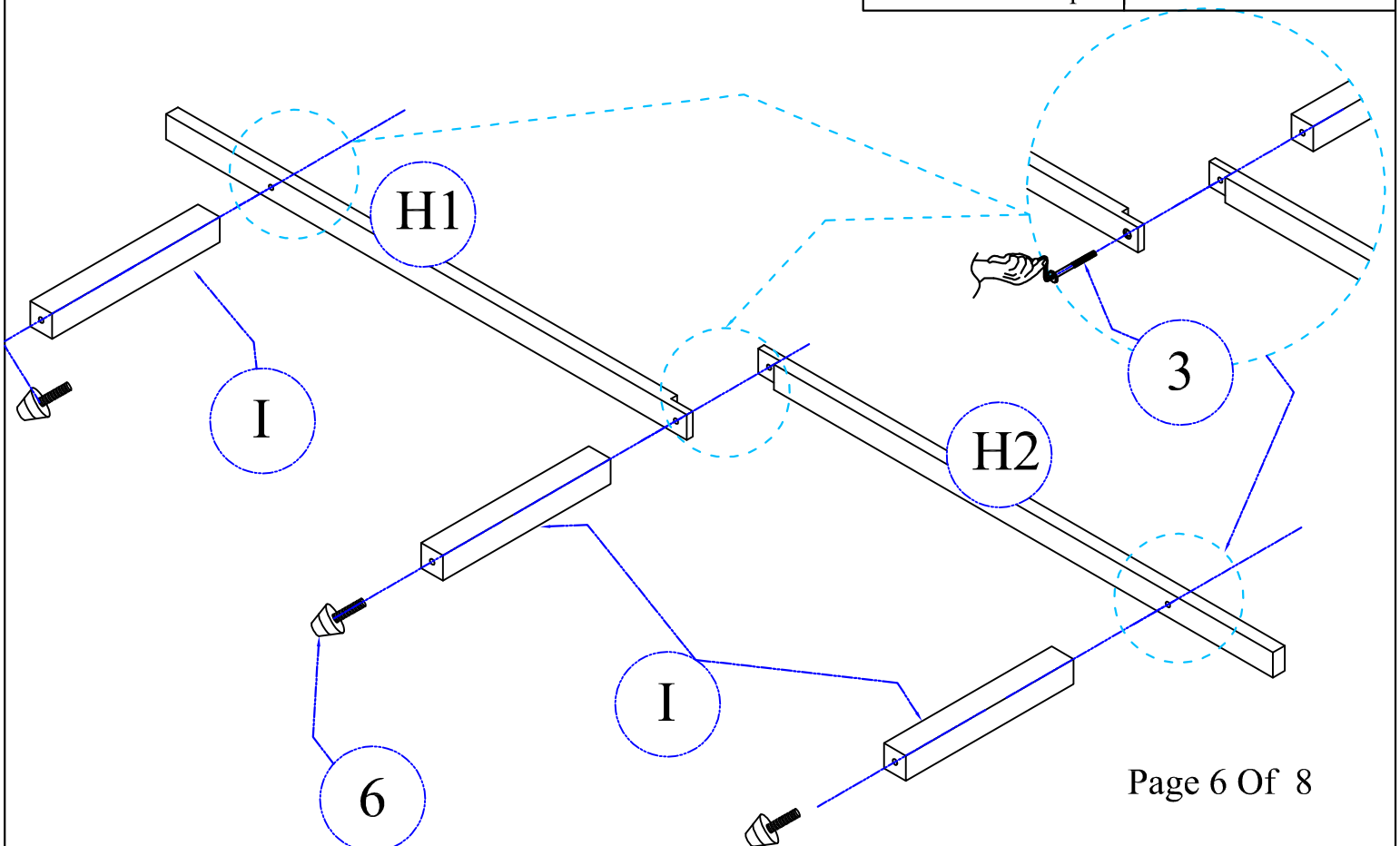
 Wood crews
 M3.5 * 15 - 2pcs

10

 Connecting Metal = 1 pc

STEP 4



6

 Adjusting screw
 Ø1/4" * 30 - 3 pcs

3

 Hex - Head bolts
 Ø1/4" * 65 - 3pcs

STEP 5

5



Wood dowel
Ø10 * 40 - 8pcs

11



Wrench Metal=1 pc

12



Stud bolt
Ø1/4" * 75 - 4pcs

13



Connecting rod -4 pcs

14



Hexanon nut = 4 pcs

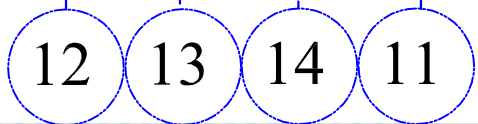
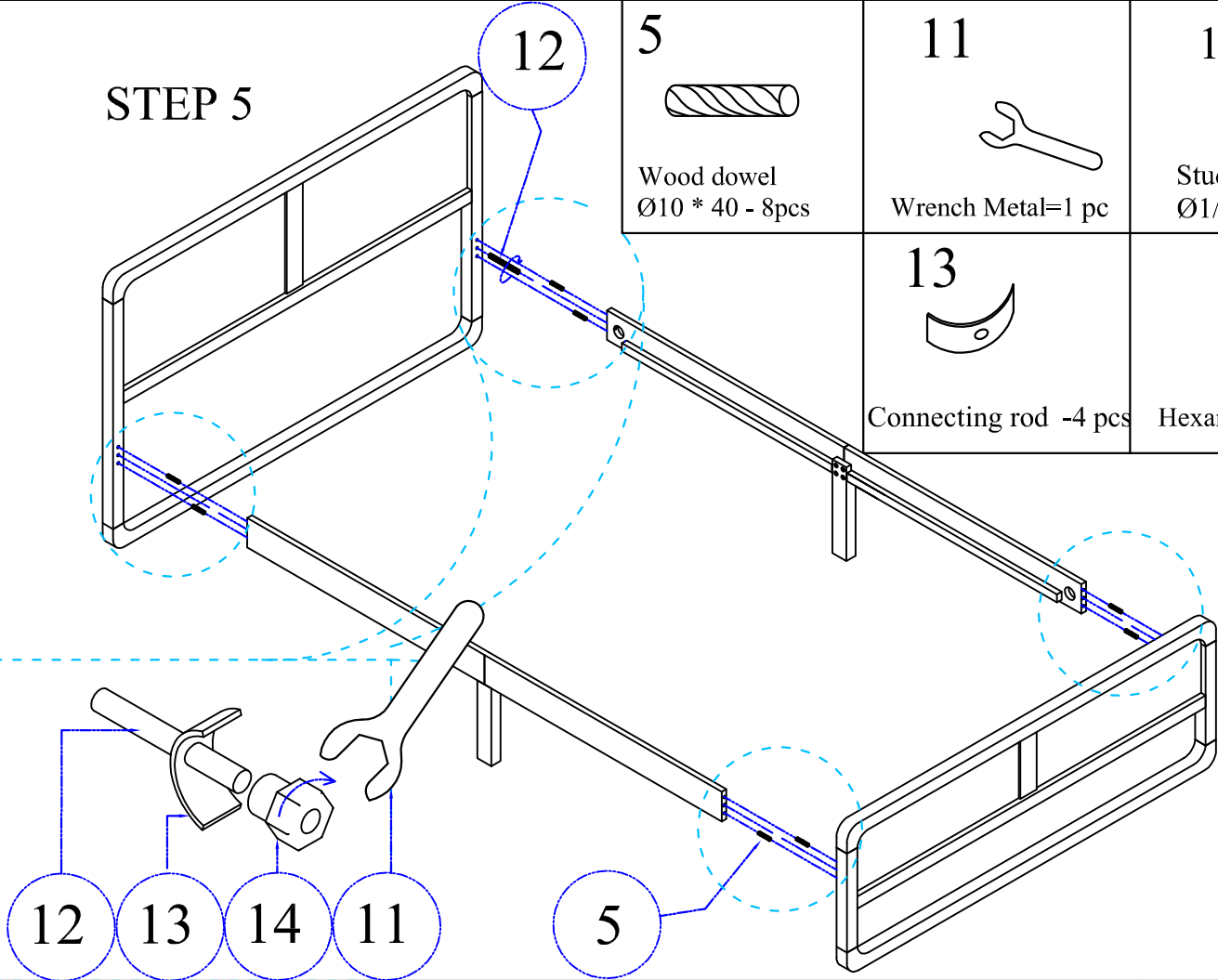

STEP 6

9



Wood crews
M4 * 30 - 24pcs

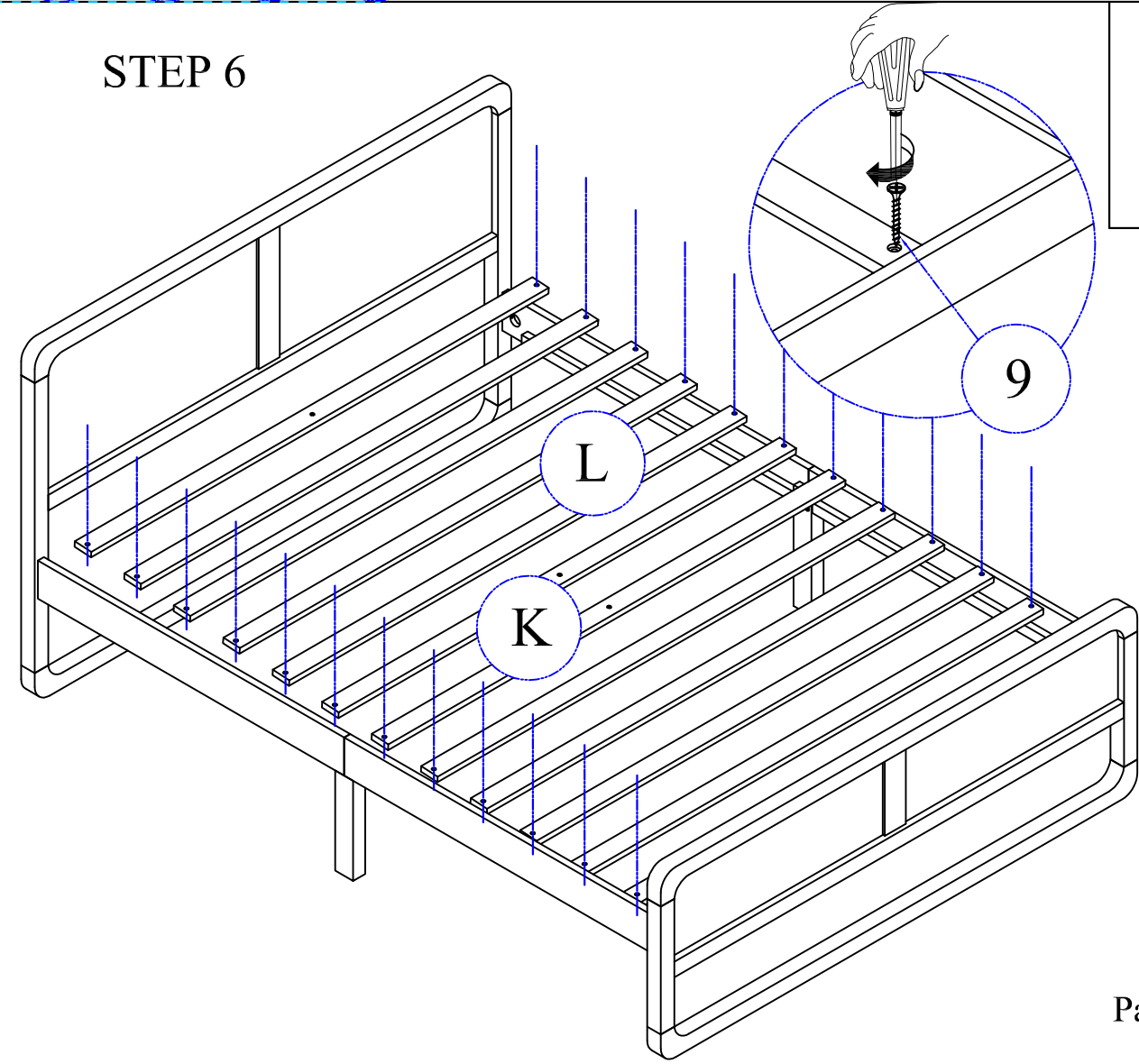

STEP 7

9



Wood crews
M4 * 30 - 4 pcs

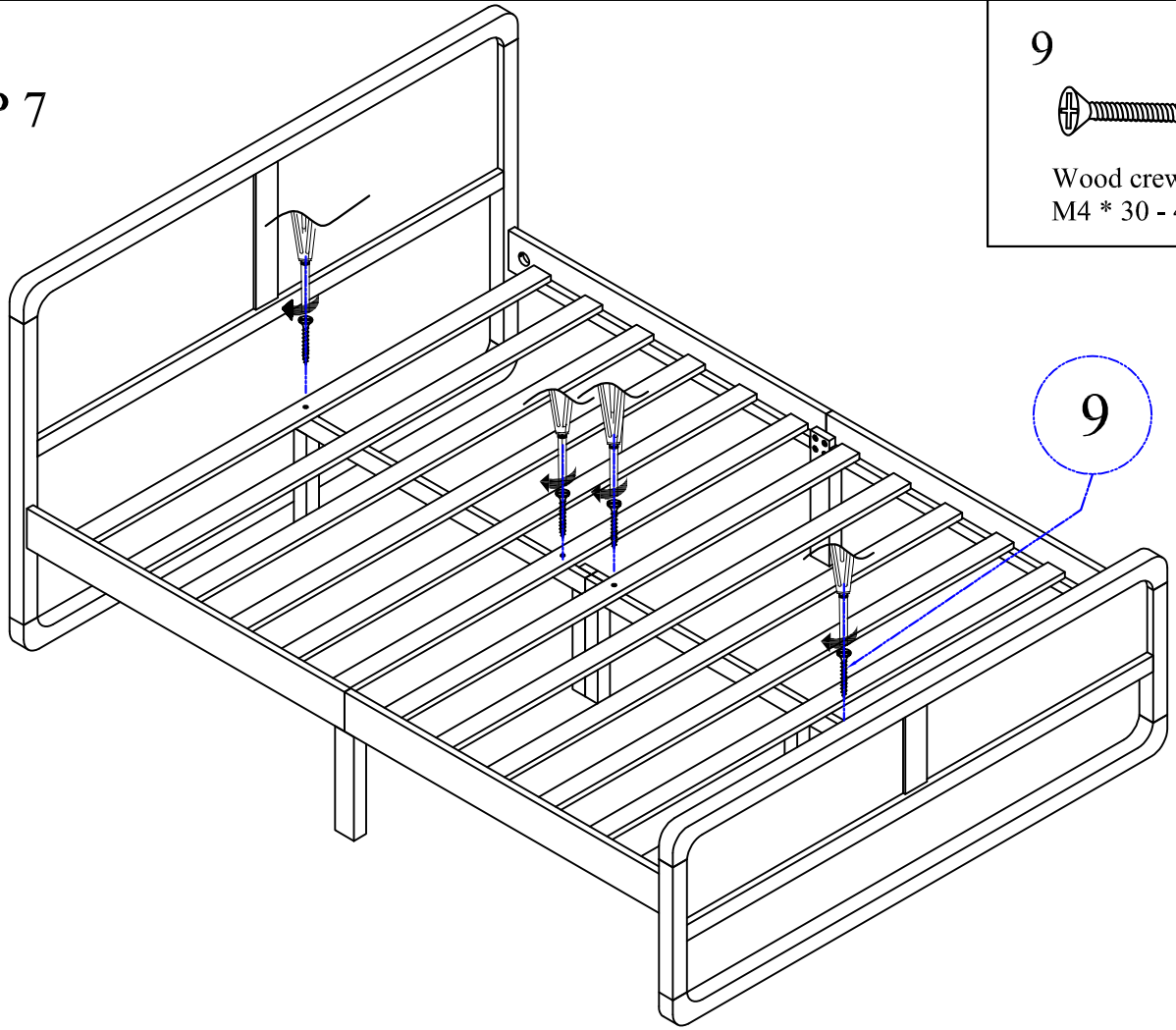

STEP 8

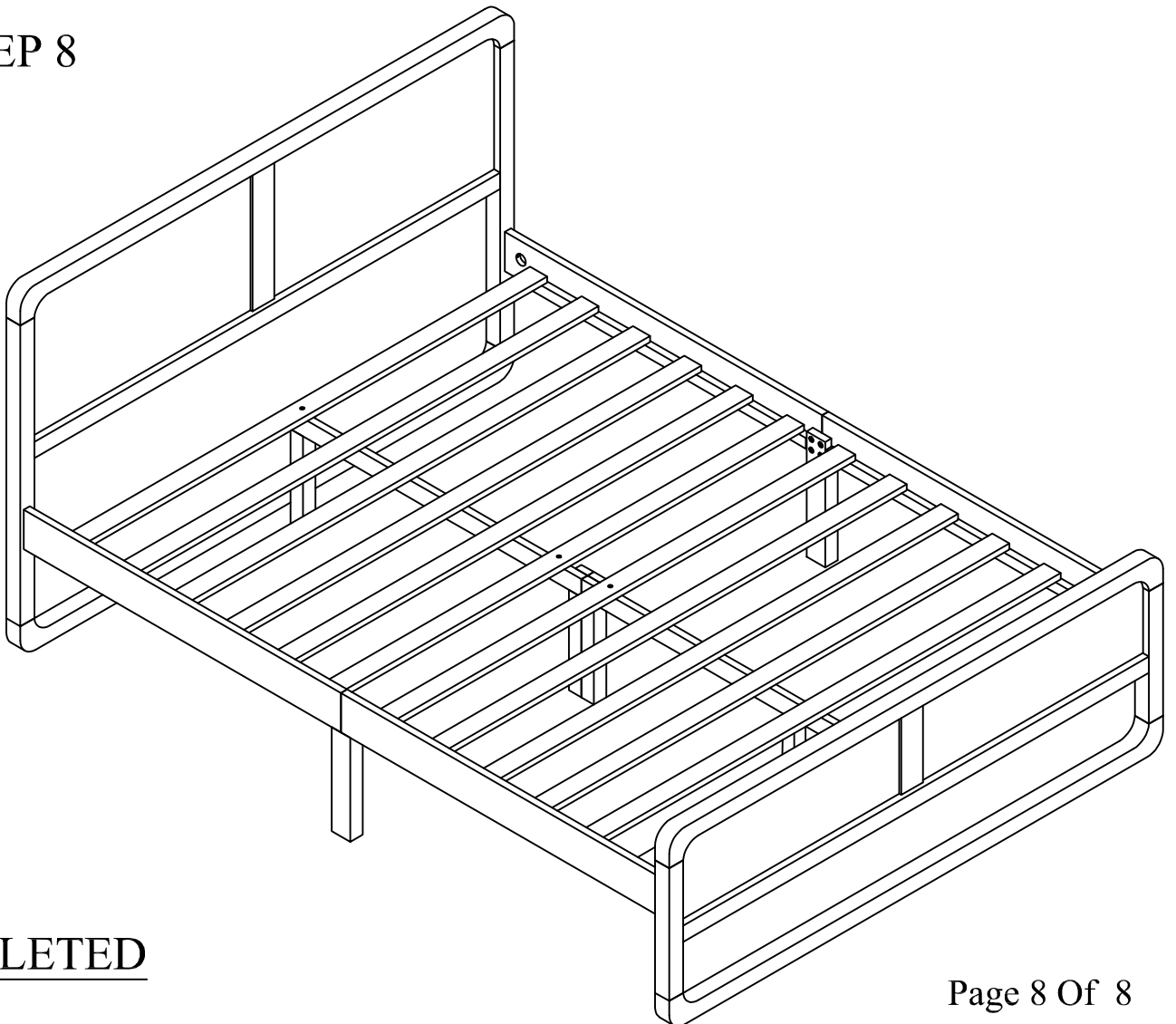

COMPLETED