

Outdoor portable Storage Shed Manual

Dear Customer,

Thank you for choosing our product! To ensure your safety and the proper usage of the product, please adhere to the following crucial recommendations during installation and use:

1. Secure the product using sandbags: To enhance the stability and safety of the product, it is imperative to use sandbags during installation. Sandbags effectively prevent unintended movement or tilting of the product, providing additional support and stability.
2. Avoid installing near or directly on air vents: Air vents can cause airflow variations that may adversely affect the normal operation of the product. Choose a location away from air vents to ensure the product's stability under various environmental conditions.

Our objective is to provide you with the highest quality and safest product experience. If you have any questions regarding installation or usage, please feel free to contact our customer service team. Once again, thank you for choosing our product, and we wish you a delightful user experience!

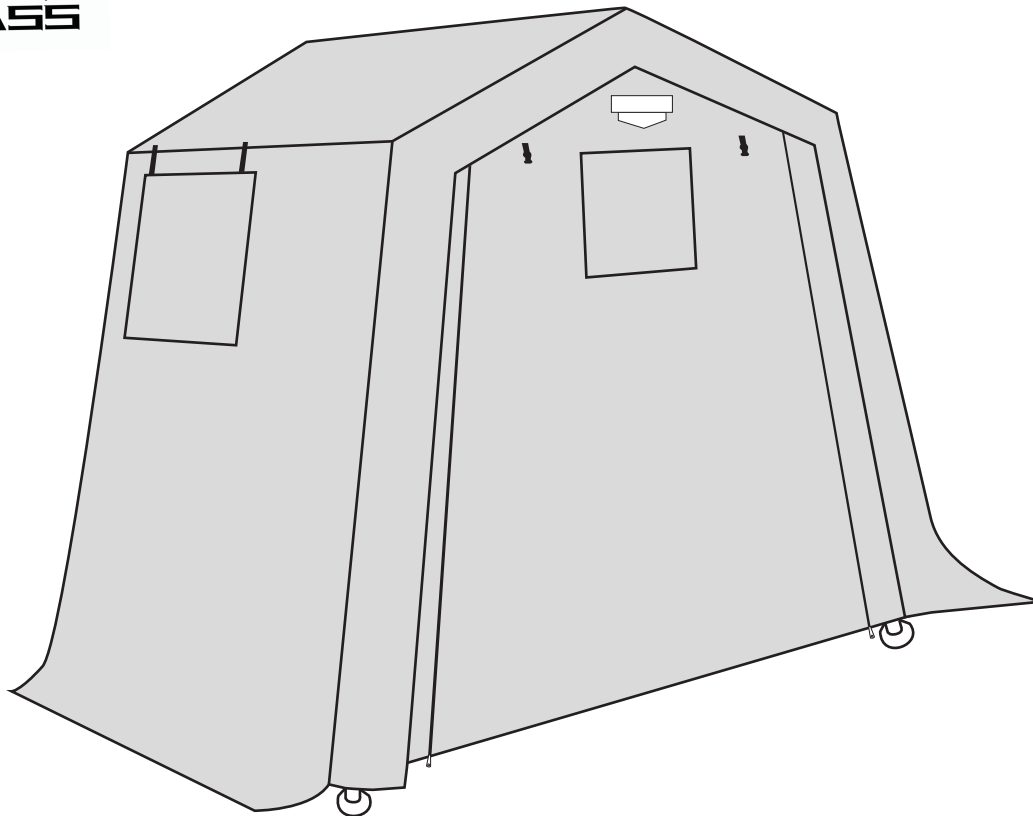







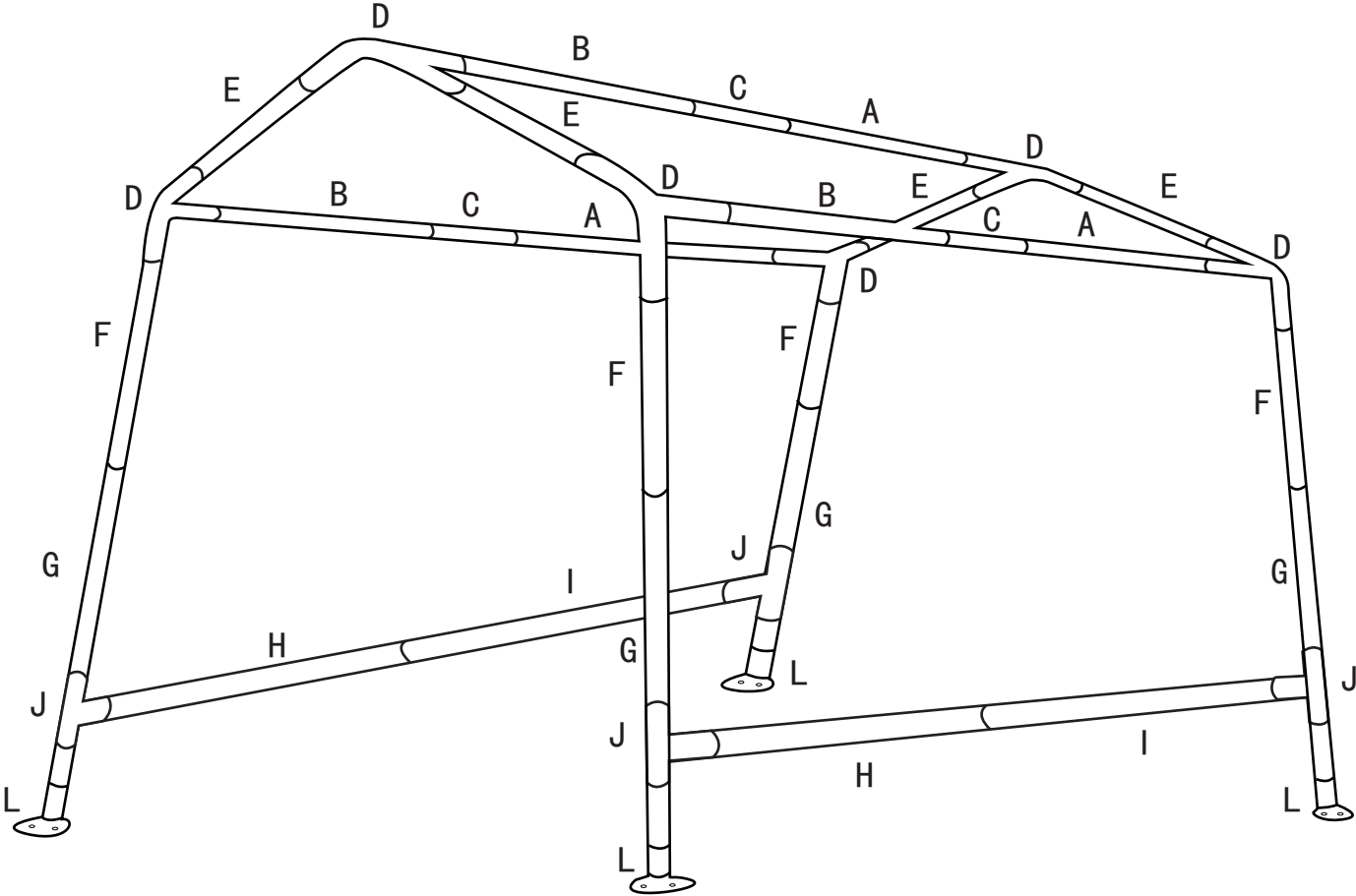

8x8FT Outdoor portable Storage Shed

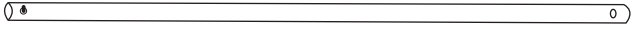

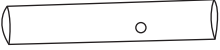

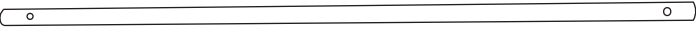
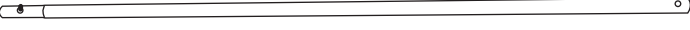
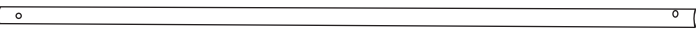
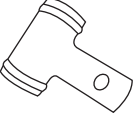

Phone:3022415039/6605538327
Email:easyhelpservice@yahoo.com
Please contact us by phone or email.

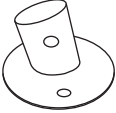
After-sales phone service hours:
US Central Time: 19:00-23:00
Seattle time: 17:00-21:00
US Eastern Time: 20:00-00:00
Toronto time: 20:00-00:00
Germany time: 8:00-11:00
After-sales mailbox service time: 7*24 hours

Assembly Diagram

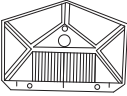
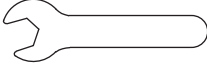

Letter	Illustration	Description	Q'ty
A		Crossbeam	3
B		Crossbeam	3
C		horizontal sleeve	3
D		Tee-junction	6
E		Slant beam	4
F		Post	4
G		Post	4
H		Fabric tube	2
I		Fabric tube	2
J		T-joint	8
K		Elastic cord	34
L		Base	4

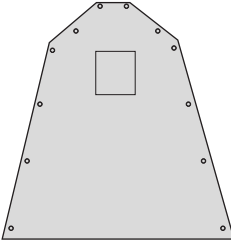
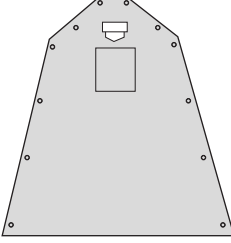
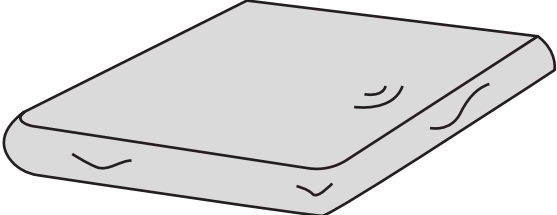
Letter	Illustration	Description	Q'ty
M1		M6*40	4
M2		M6*50	4
N		Stake	8
O		Solar Lamp	1
P		Wrench	1
Q		Wrench	1
R		Sand bags	2
V		Hook	4
S		Door	1
T		Door	1
U		Canopy&Wall	1

Step 1

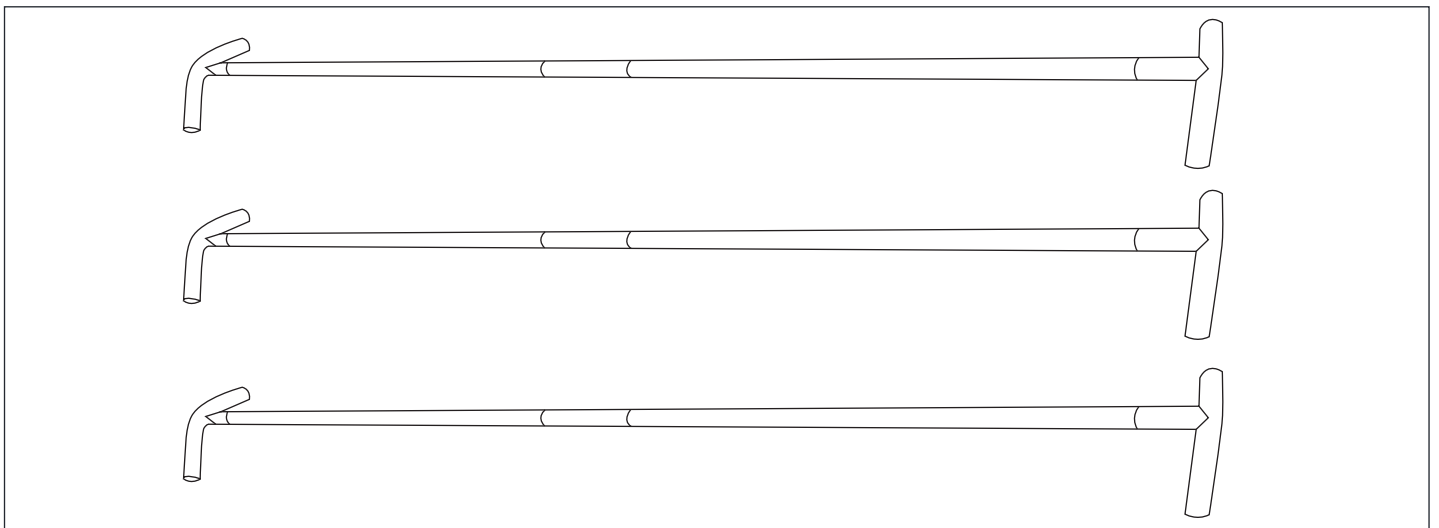
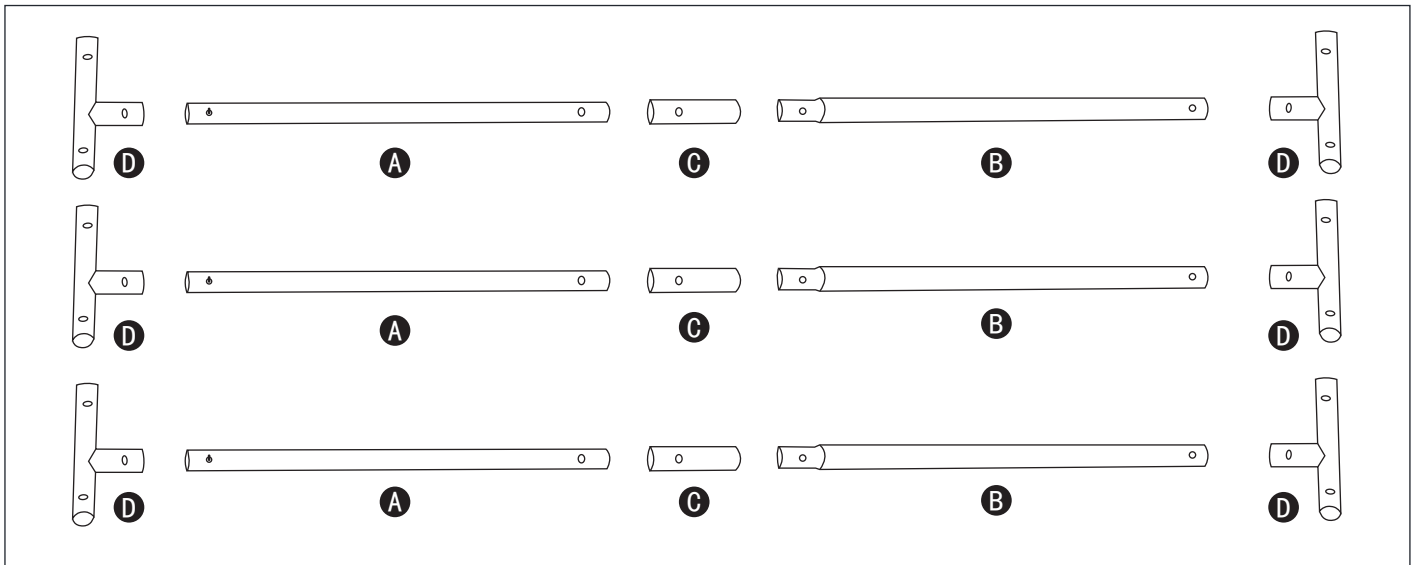

1. Connect D to A. Insert A into tube C, then connect B to C, ensuring that the hole on C aligns with the joint between A and B. Finally, connect B to D.

Step 2

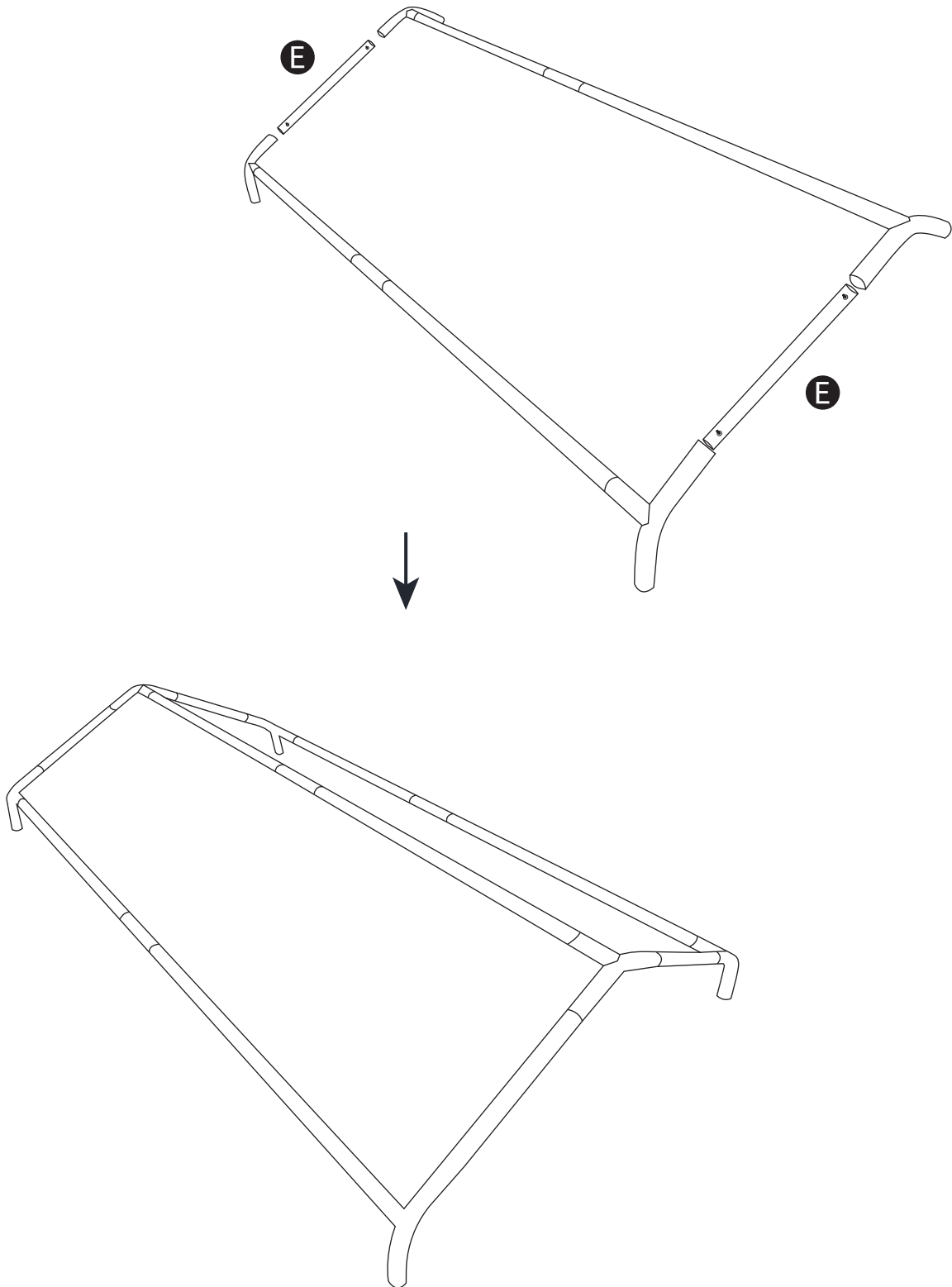

2. After assembling $D \rightarrow A \rightarrow C \rightarrow B \rightarrow D$ in order, connect both ends of E to the two D components on either side.

Step 3

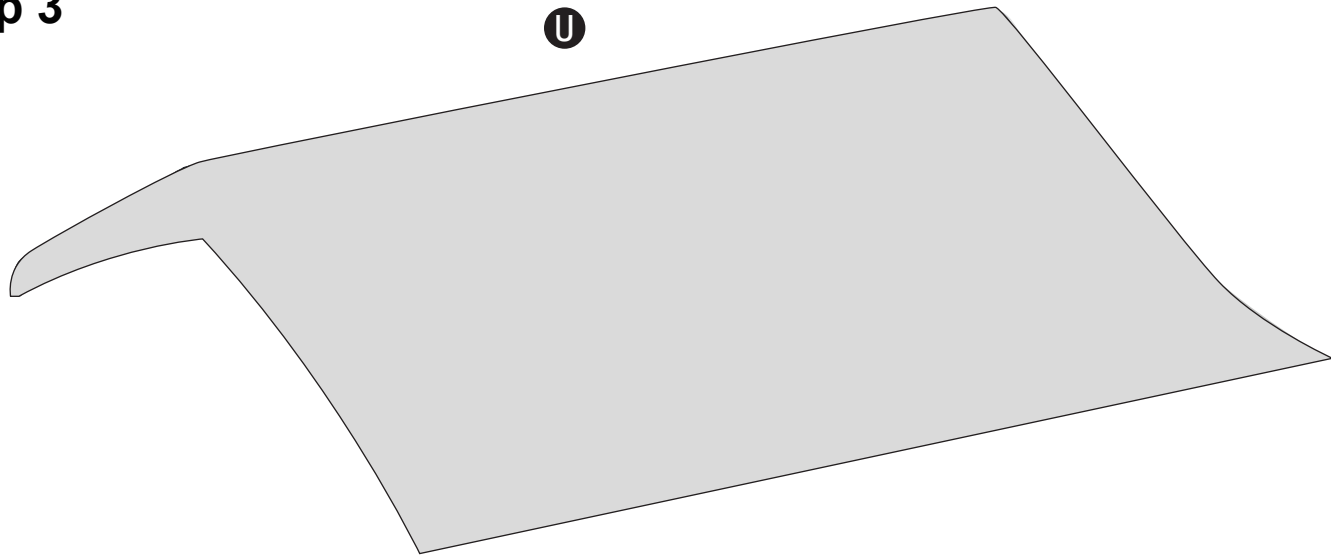

3. Once the roof structure is assembled, place the canopy fabric U over the top structure.

Step 4

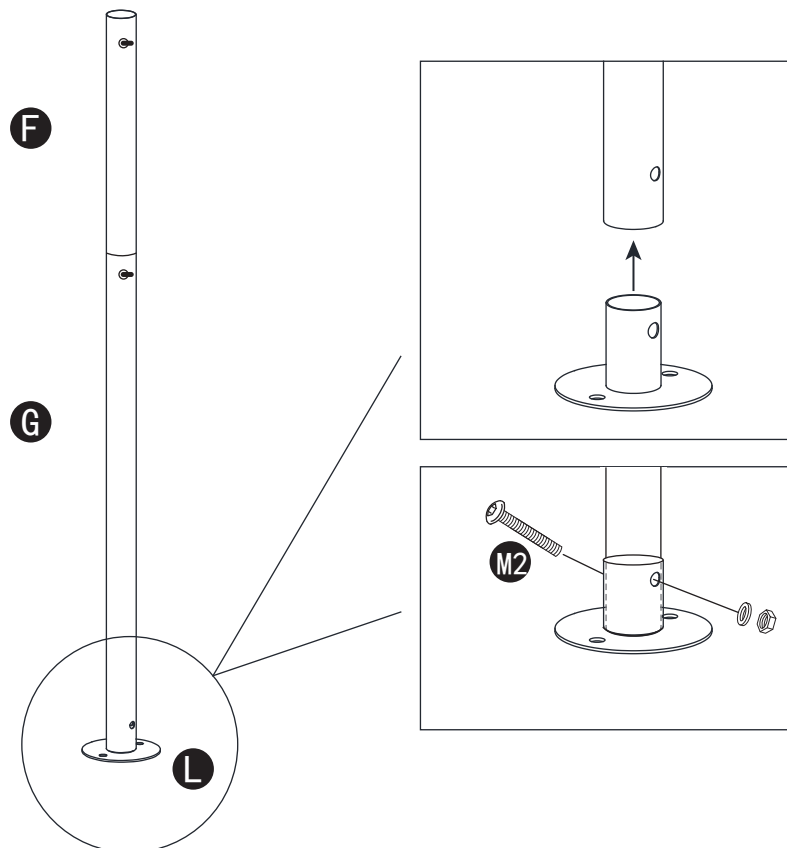

4. Assemble the leg tube structure: Connect the blind hole of F to G. Attach the other end of G to L, aligning the through-hole of G with the base L, and secure it using part M2.

Step 5

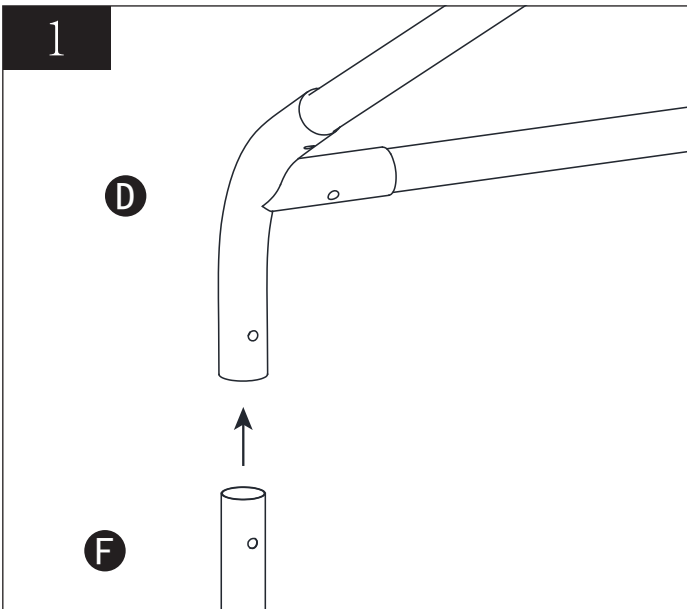
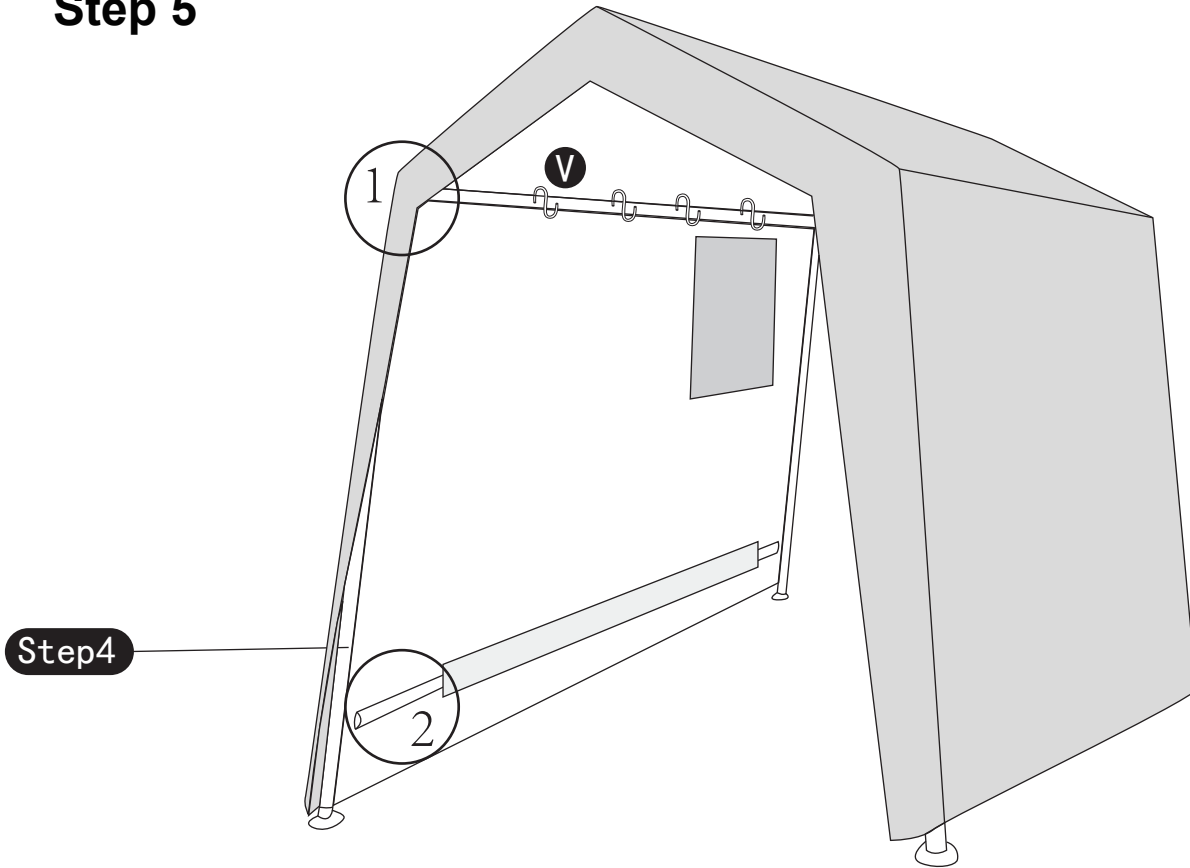

Slide the Post into the Tee-junction (E) and Cross fittings (F).

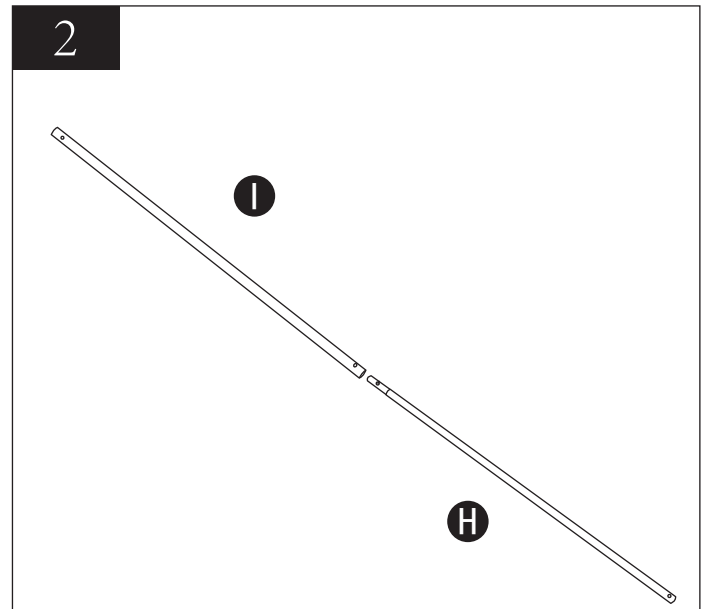

Insert the connected (I) and (H) into the fabric conduit below the surrounding fabric.

Step 6

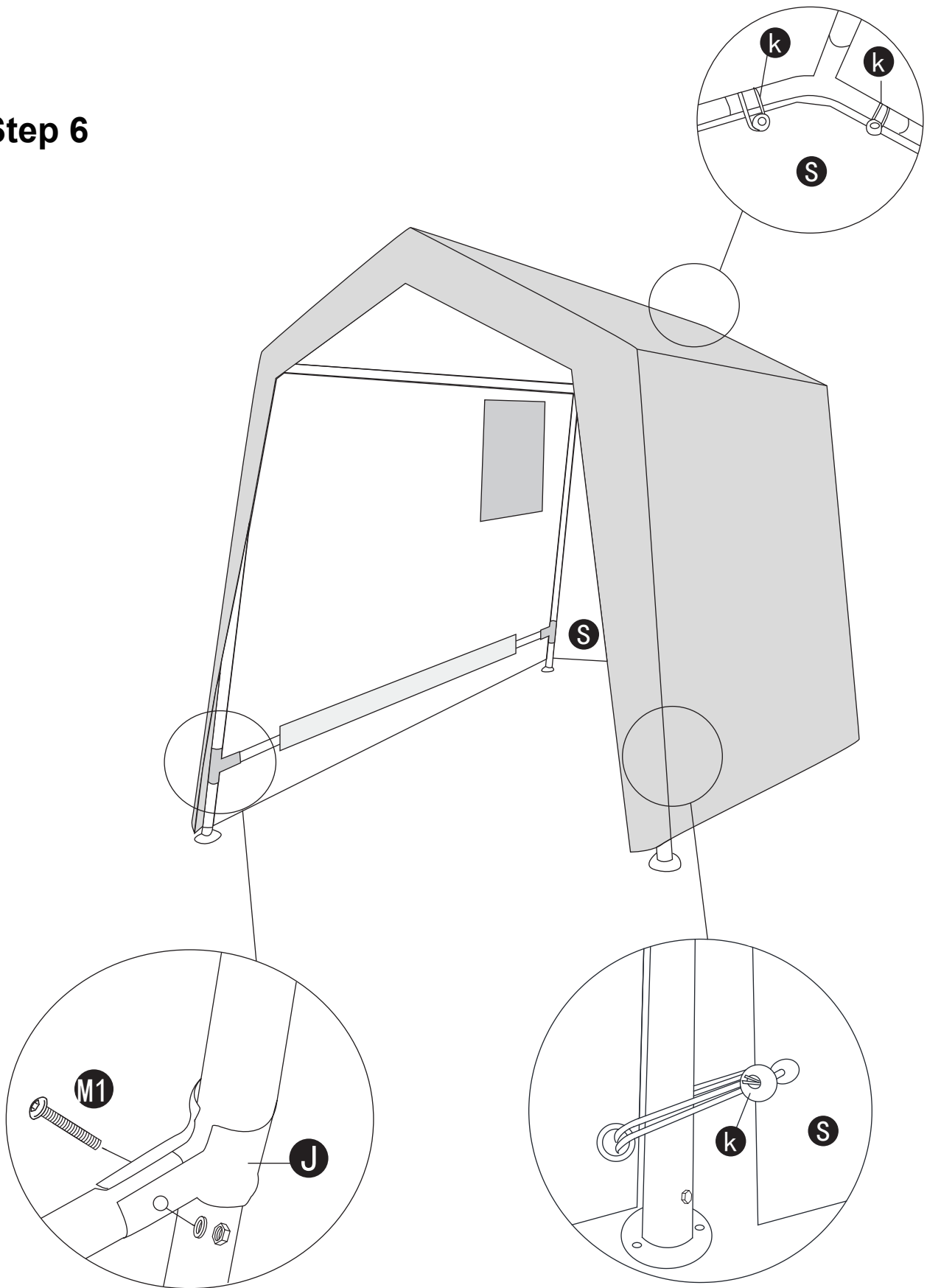

6. Use M1 to secure the T-shaped connector J to the assembled leg tube structure near the base L. Once installed, pass K through the corresponding hole on S and secure it in place.

Step 7

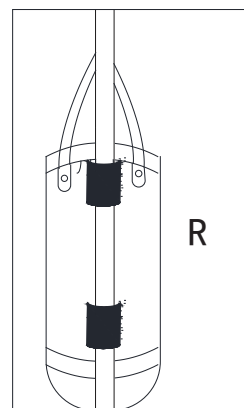
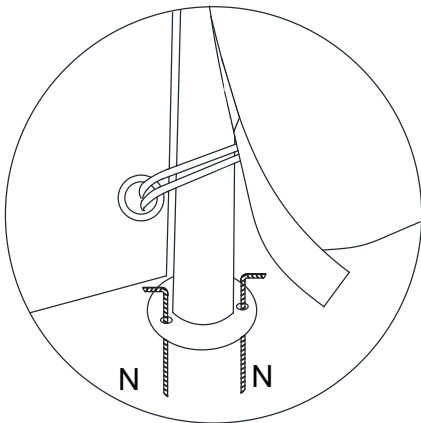
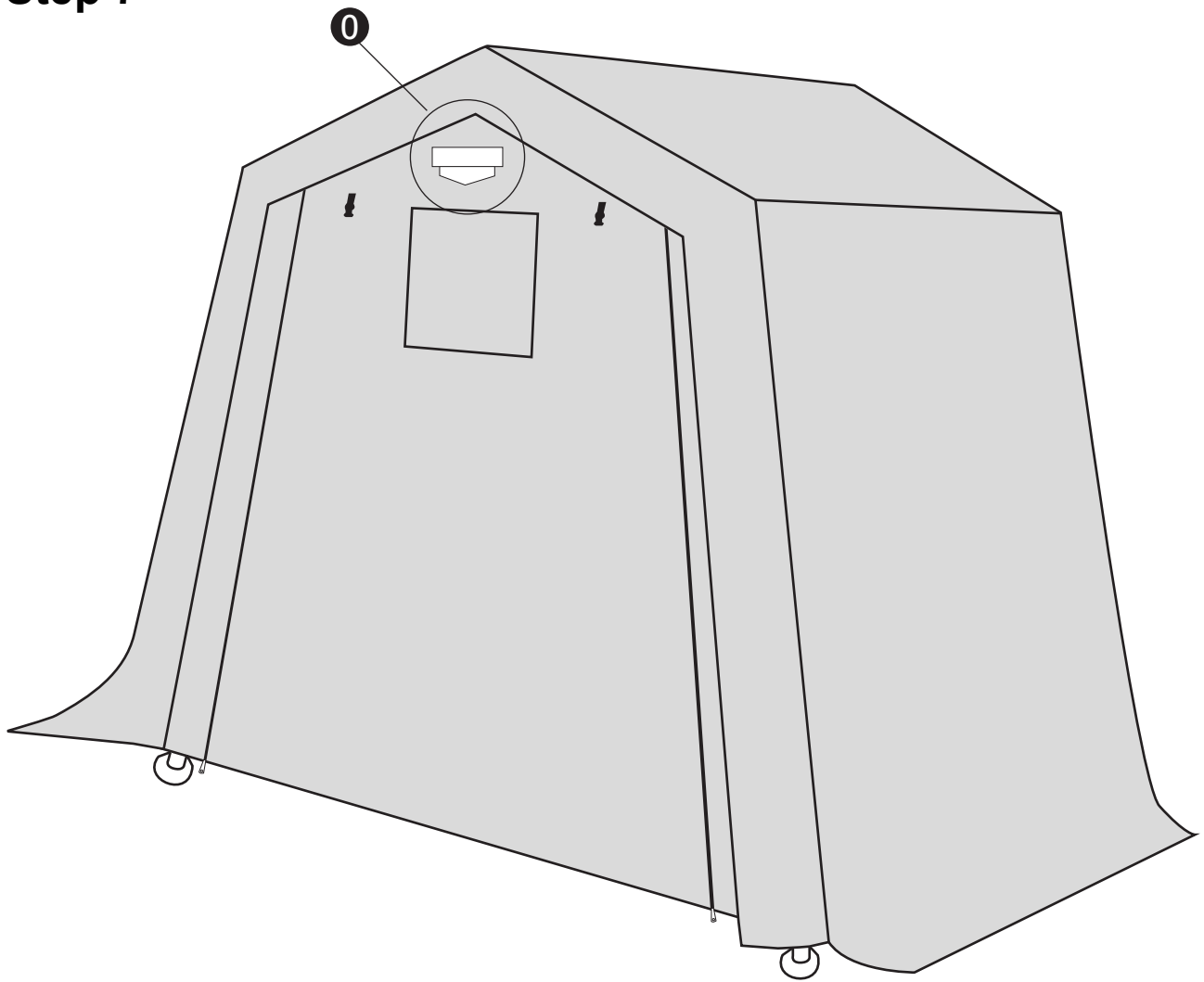

7. Insert ground stake N into the hole on base L and hammer it into the ground. Then, secure sandbag R around the tube.