

Installation instruction

Luxury Decorative Ceiling Fan

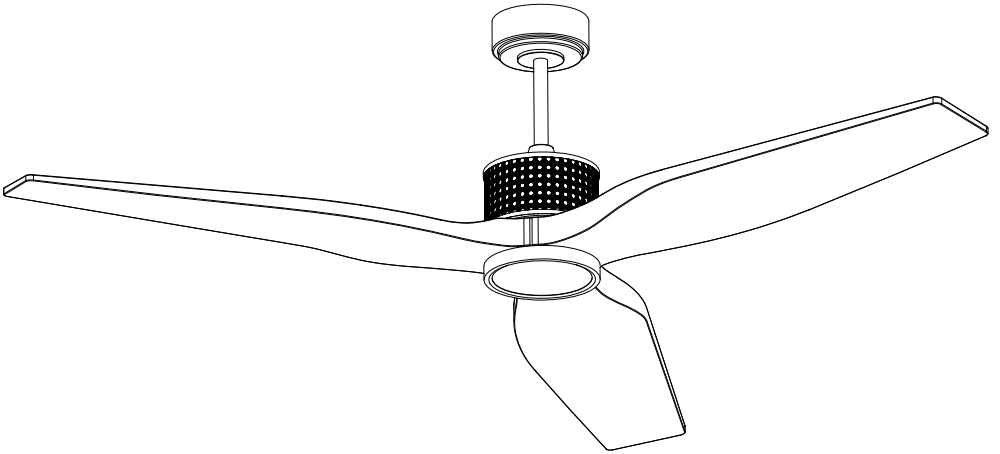

52 inch

PLEASE READ AND SAVE THESE INSTRUCTIONS

GET MORE SUPPORT

Should you experience any issues while operating any of our products ,you can directly reach out to our Customer Support

I.Precautions

Before using this ceiling fan with light, please read this manual carefully and operate strictly in accordance with the procedures.

- 1 The input voltage of this product: 120V/60Hz
- 2 If you have insufficient knowledge of electrical appliances, be sure to hire an experienced expert to install them.
- 3 Before installing and disassembling the ceiling fan light, please turn off the power first. The installation must be installed in the order of ground wire, live wire, and neutral wire. Before disassembly, it must be disassembled in the order of neutral wire, live wire and ground wire to avoid electric shock.
- 4 The ceiling fan must be installed on a solid ceiling, and the location of the ceiling fan must be able to withstand a gravity greater than 60 KG.
- 5 When installing the ceiling fan, all screws must be securely locked.
- 6 When the ceiling fan is rotating, no objects should touch the blades to avoid danger.
- 7 The angle and elevation of the leaf frame are determined after many repeated measurements, so it cannot be changed at will. When installing the leaf frame and blades, special care should be taken not to force collisions. If the angle and elevation angle of the leaf frame are deformed that will cause the ceiling fan to shake.

II.Prepare tools before installation:



**Electrical
Adhesive tape**



**14open
spanner**

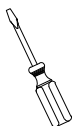

**Slotted
Screwdriver**

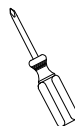

**Phillips
screwdriver**

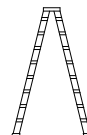

**Telescoping
ladder**

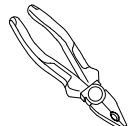

Pliers

III. Basic parameters

- 1 Voltage: 120V/60Hz
- 2 Power: Motor power: 40W
- 3 Speed + Color change: 6speed+3 color temperatures
- 4 Number of rotating leaves: 3 blades
- 5 Fan blade material: Wood
- 6 Motor material: Pure copper wire winding and high-quality silicon steel stator, high efficiency, uper quiet, energy saving.
- 7 Control method: Remote control
- 8 Diameter: 52 inch
- 9 Reversible :YES

IV. Installation steps and instructions.I.Precautions

1 Ceiling Fan kit

Before the ceiling fan is installed, there are the following accessories in the carton,please check them one by one, if there is no shortage, you can install it.

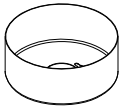

1*Canopy

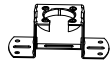

1*Mounting Bracket

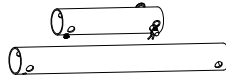

2*Downrod



1*Coupling cover



1*Canopy cover

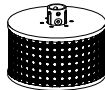

1*Motor

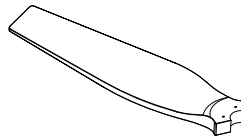

3*Blades



1*Lamp Plate+LED



1*Lampshade

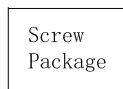

1*Screw Package

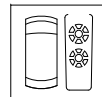

1*Remote control
1*Receiver



1*Instruction

V. Mounting Bracket Fasten Method

1. Wood ceiling: Drill the mounting bracket directly into the wood ceiling with wood screws (4 pieces) or Use tools to fix the mounting bracket tightly. (The ceiling must bear more than 60KG).

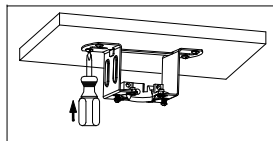
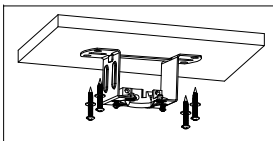

2. Concrete ceiling: First use an $\varnothing 8\text{mm}$ hammer drill bit to drill the hole according to the length of the expansion screw, then use the equipped expansion screws (2 Pieces) to fix the bracket on the ceiling, and then tighten the nut of the expansion screw.

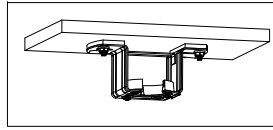
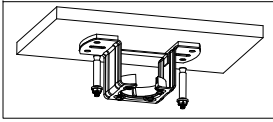

Please use 8mm drill hole before installing with M6 expansion screws

3. Install the hanger bracket to the outlet box
 - a. Take off the screws on the outlet box.
 - b. Install the hanger bracket to the outlet box by screws

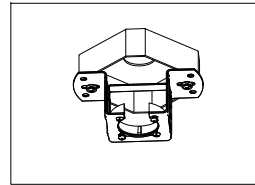
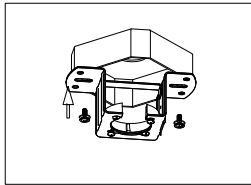
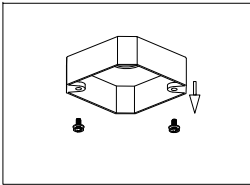

Note:

- a. According to the ceiling of different materials, use different screws to fix the mounting bracket (as shown above).
 - b. After the bracket is fixed, it must be determined to be able to bear the weight of more than 60 kg (test pull by hand) for safety.
 - c. Ceiling fans cannot be installed on gypsum ceilings.
 - d. To reduce the risk of fire, electric shock, or personal injury mount to an outlet box marked "Acceptable for Fan Support". Use the mounting screws provided with the outlet box. Most outlet boxes commonly used for supporting lighting fixtures are not acceptable for fan support and may need to be replaced.
- Consult a qualified electrician if in doubt.

VI. Suspension Installation

1. Select the downrod
 - a. There are two downloads of 4.5inch and 12inch in the package, customers can choose according to the height of the house.
 - b. The normal default is to install the 4.5inch down rod.
 - c. How to replace the 12 inch down rod:

Notice: Make sure the fan blades at least 7 feet above the floor

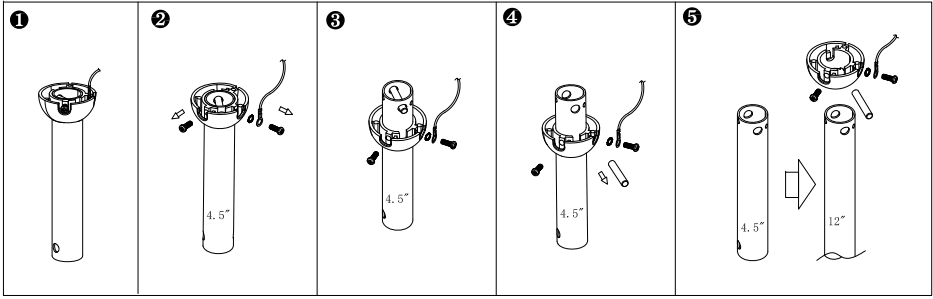

- 1). Loosen the two fixing screws (as shown in Figure 2).
- 2). Push the down rod upwards (as shown in Figure 3) out of the horizontal tip (as shown in Figure 4).
- 3). Then pull out the 4.5 inch down rod to replace another 12 inch down rod (as shown in Figure 5).
- 4). After replacement, follow the above installation steps 4-3-2 to install until it is restored to the state shown in Figure 1.
- 5). Finally, you must pay attention that the two fixing screws must be firmly locked.

2. How to install Suspension Installation

- ①、 Remove the positioning screws from the fan body as follows and place them side by side to proceed to the next step (Figure 6)
- ②、 Get off the pin off the down rod by remove the R clip, and get the lead wire through the down rod and canopy, then seat the down rod into the fan body & rotate the down rod until the holes on the down rod will match with the holes on the fan body, finally, you should get the pin through the holes and fix the pin by the R clip in another side (Figure 7)
- ③、 Tighten the two set screws removed previously.

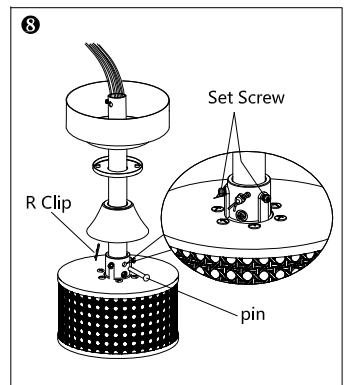
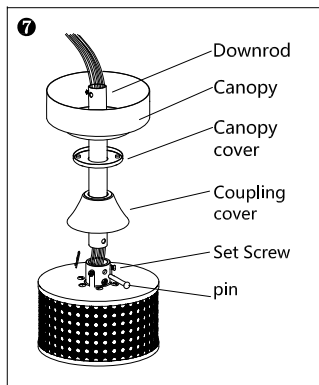
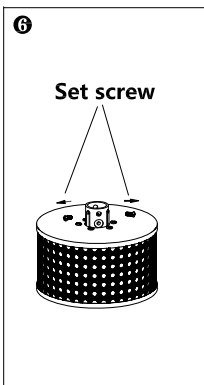

3. Hang the fan on the hanger, and then slowly rotate the fan down rod to make the lugs on the hanger fit with the groove of the hanging ball on the down rod (Figure 9)

※The groove on the down rod ball must be exactly the same as the lug on the hanger.

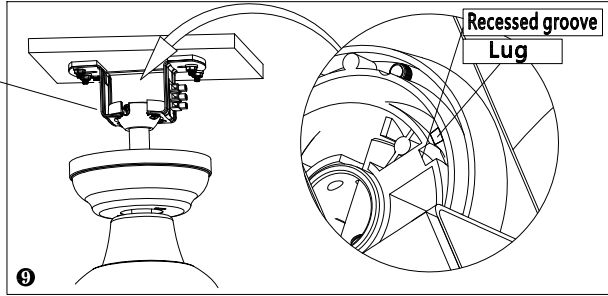

VII. Attaching Fan Blades

1. Take out the blade screws in the hardware bag (as shown in Figure 10)
2. Align the blade screw hole with the motor blade plate hole, and tighten the screws in turn (Figure 11)

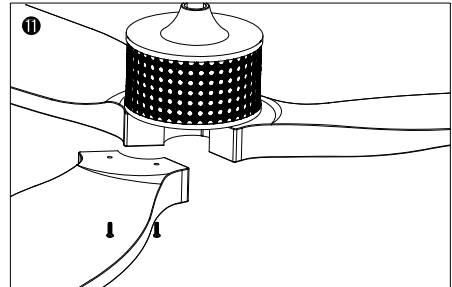

screws to fix the blades

VIII. Install lamp

1. Remove the three fixing screws from the lamp holder.(Figure 12)
2. Please plug the 2 light wires to the LED board properly, and check whether the driver output wires and the LED source board are tightly inserted, lock the lamp plate to the lamp holder with screws.(Figure 13-14)
3. Install the lamp shade in place and rotate the lamp shade clockwise. (Figure 15-16)

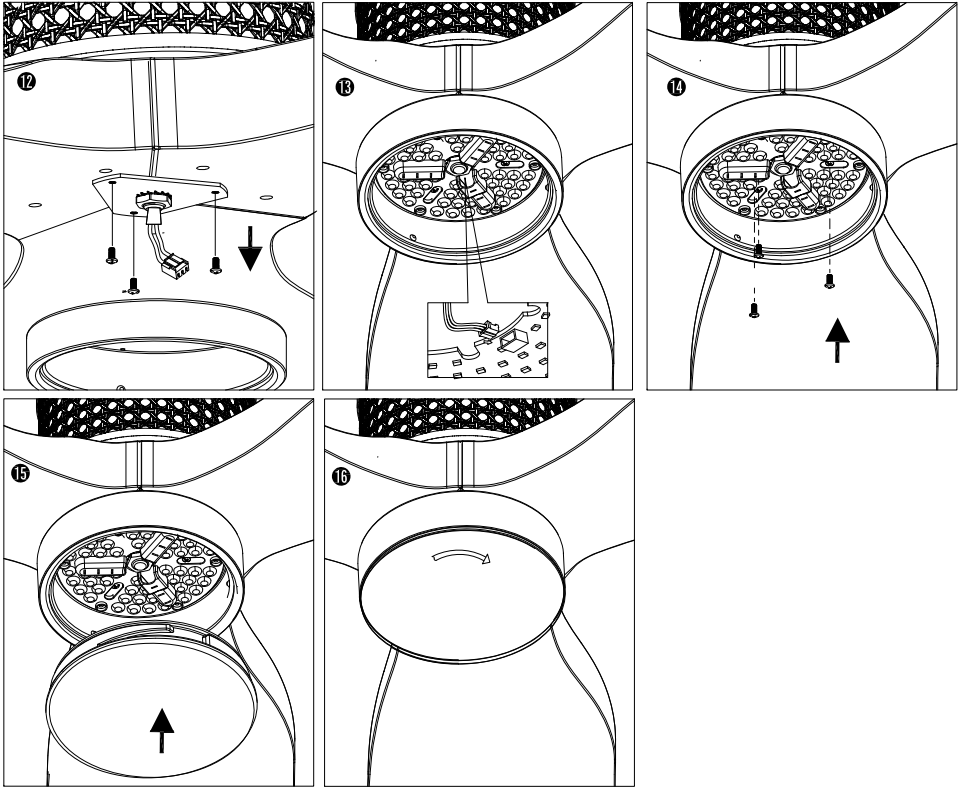

VIII. Wiring

※The all-pole disconnect circle breaker with a contact distance of 3mm must be connected to the fixed wiring

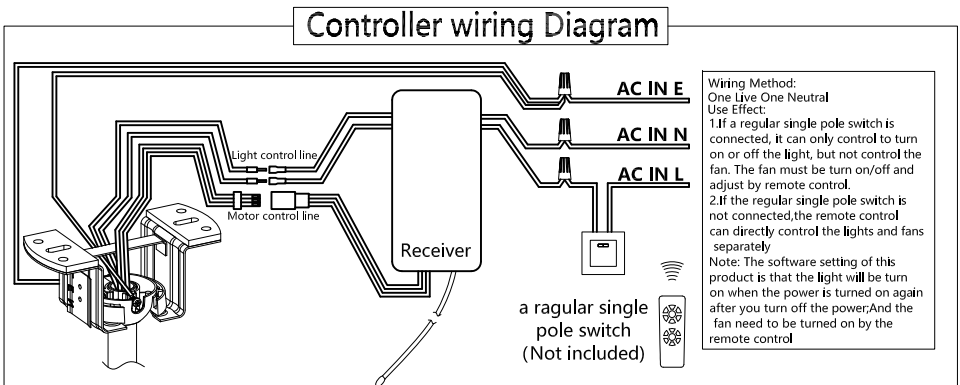

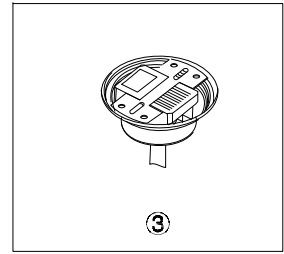
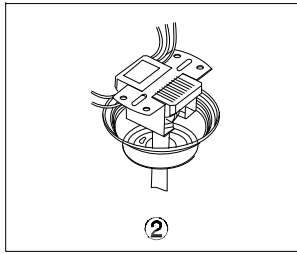
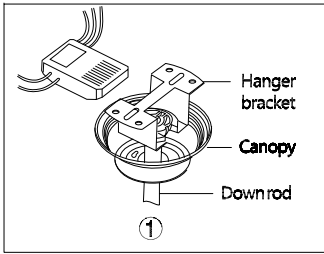

1. Connect the ground wire from ceiling to three green wires from the mounting bracket, the hanger ball on the down rod, and the receiver (AC IN E).
2. Connect the live wire from ceiling to receiver black wire (AC IN L).
3. Connect the neutral wire from ceiling to receiver white wire (AC IN N).
4. Connect the upper (red, black, white) plug of the motor to the upper (red, black, white) plug of the receiver.
5. Connect the blue wire (FOR LIGHT) from motor to blue wire (FOR LIGHT) from receiver.
6. Connect the white wire (FOR LIGHT) from motor to white wire (FOR LIGHT) from receiver.

X. Canopy Installation

After wiring, please loosen the two screws pre-installed on the mounting bracket to match the two holes on the canopy (Figure 17)

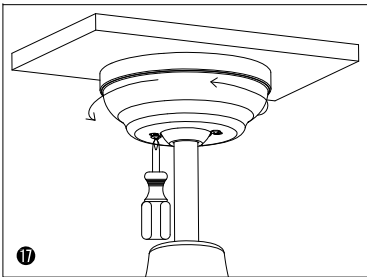

XI. Balance adjustment method of ceiling fan

If there is any wobble after ceiling fan installation, please confirm whether the screws that fix the hanger ball, mounting bracket, hanger, blade holder, and blade are locked. If one of the above parts is not locked, please re-lock it. If it is locked, please adjust it as follows.

1. Change the position of the fan blades:
 - a. There is no improvement after the swap blades position. Please remove the fan blades 2 and 3 and re-lock each other to observe the effect.

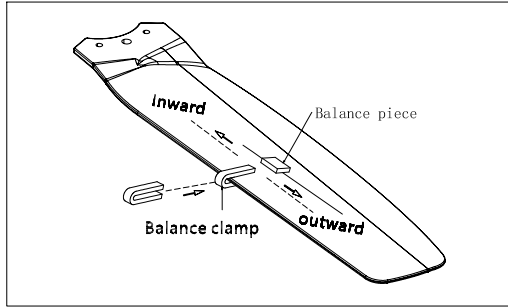
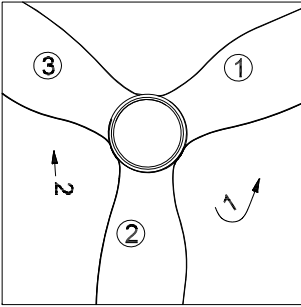

2. Adjust with balance kit

- a. Take out the balance bag from the package box, use a balance clamp to select one of the fan blades and clamp the balance clamp on the edge of the tail end of the fan blade (Figure 18)
- b. Turn on the fan switch to see whether the wobble of the ceiling fan has been reduced. If it does not improve, try another fan blade. Experiment with all the fan blades in turn to find the blade with the weakest clamping balance.
- c. Clamp the balance clamp on the fan blade with the weakest wobble, move it in or out on the edge of the fan blade, turn on the ceiling fan to find the best position of the balance clamp to troll the wobble balance (Figure 18)
- d. Take the balance sticker, tear off the double-sided tape of the balance sticker, and stick the balance sticker on the center of the blade at the position of the balance clip (Figure 18)

XII. Precautions

Warning

In order to prevent fire and electric shock, it is forbidden to install and use the electric switch which is not equipped with this ceiling fan.

Maintenance and repair of ceiling fans

1. It is recommended to check the connecting parts of the fan at least once a year, such as the hanger, the hanging pipe fastening screw and the fan blade, to ensure that their connection is still safe and reliable.
2. Clean the ceiling fan regularly to keep the surface clean and clear. When removing surface dust, please use a soft brush or cloth. When removing oil or laminate, wipe it off with a slightly wet cloth. Do not rinse with water directly.
3. Motor bearing is already provided with grease, do not add lubricating oil to the motor of ceiling fan. To avoid scratching the surface.

XIII.Ceiling Fan Troubleshooting Solutions & Common Problems

can't start	1.Check whether the fuse of the external power line of the ceiling fan is blown, whether the automatic protection switch is tripped and the circuit is broken.
	2. Check whether the voltage is seriously lower than the rated voltage of the ceiling fan.
	3.Check whether the internal wiring of the ceiling fan is loose or has poor contact.
Noise	1.Ensure the ceiling fan is not severely impacted before installation
	2. Make sure that the hanging pipe connecting bolt is installed correctly and the hanging pipe solenoid is locked.
	3.The new ceiling fan allows a 24-hour "trial period",after the tria period, most of the ceiling fan noise will disappear.
	4.It is not recommended to install on wooden ceilings, steel structures or prefabricated panels, as this will amplify the sound.
The lamp is defective	1.Check whether the connection wire of the lamp is loose.
	2. Check whether the light switch is damaged, the wire end is loose or the contact is poor.
	3. Check whether the light source is burned out
Fan wobble	1. Check whether the mounting bracket is locked
	2. Check if the screw of the lock blade is locked
	3. Check whether the screw of the blade retracted to the motor is locked
	4.Can it be installed on the inclined ceiling? Yes, pay attention to the inclination angle not exceeding 15 degrees(pay attention to whether the hanger ball will press the fan receiver)

