

Natural Expressions

Faux Wood Armrest Conversation Set - Chair

Assembly Instructions

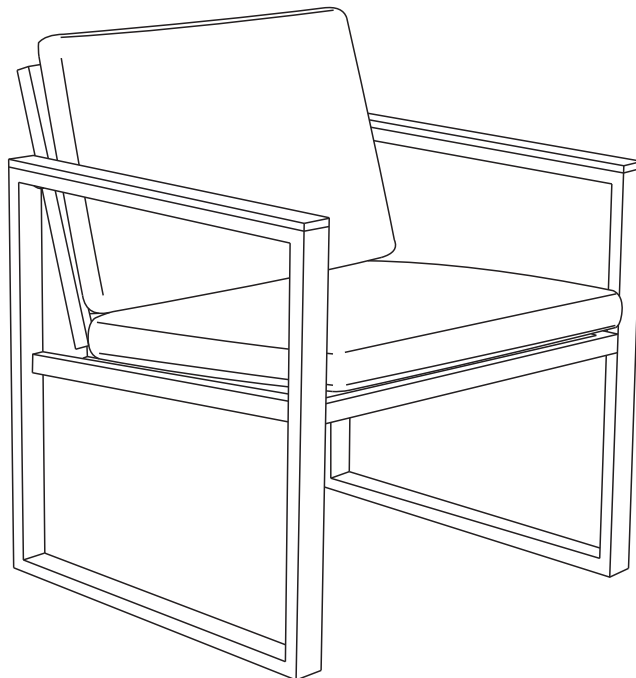

WARNING

- 1. This set is mixed packed into 2 boxes, please wait one more day if does not arrive on the same day*
- 2. Please confirm all parts correct before assemble*
- 3. Do not tighten fastening fully until assembly is complete*
- 4. DO NOT USE POWER TOOLS. Power tools can overtighten screws and strip threads*











If you have any questions ,feel free to contact us :

ne.us@topsunholdings.com

Tel : (317)334-0364 ext. 17

 **WARNING:** This product can expose you to chemicals including Di(2-ethylhexyl) phthalate (DEHP), which is known to the State of California to cause cancer, and birth defects or other reproductive harm. For more information go to www.P65Warnings.ca.gov.

PARTS LIST

CODE	PARTS	QTY.	CODE	PARTS	QTY.
A	 SEAT&BACK	2PCS	AA	 BOLT CAP(M6)	16PCS
B	 ARM-L	2PCS	BB	 BOLT CAP(M6*35)	12PCS
C	 ARM-R	2PCS	CC	 WASHER(M6)	12PCS
D	 BACK CUSHION	2PCS	DD	 NUT CAP(M6)	4PCS
E	 SEAT CUSHION	2PCS	EE	 ALLEN KEY	1PCS

1

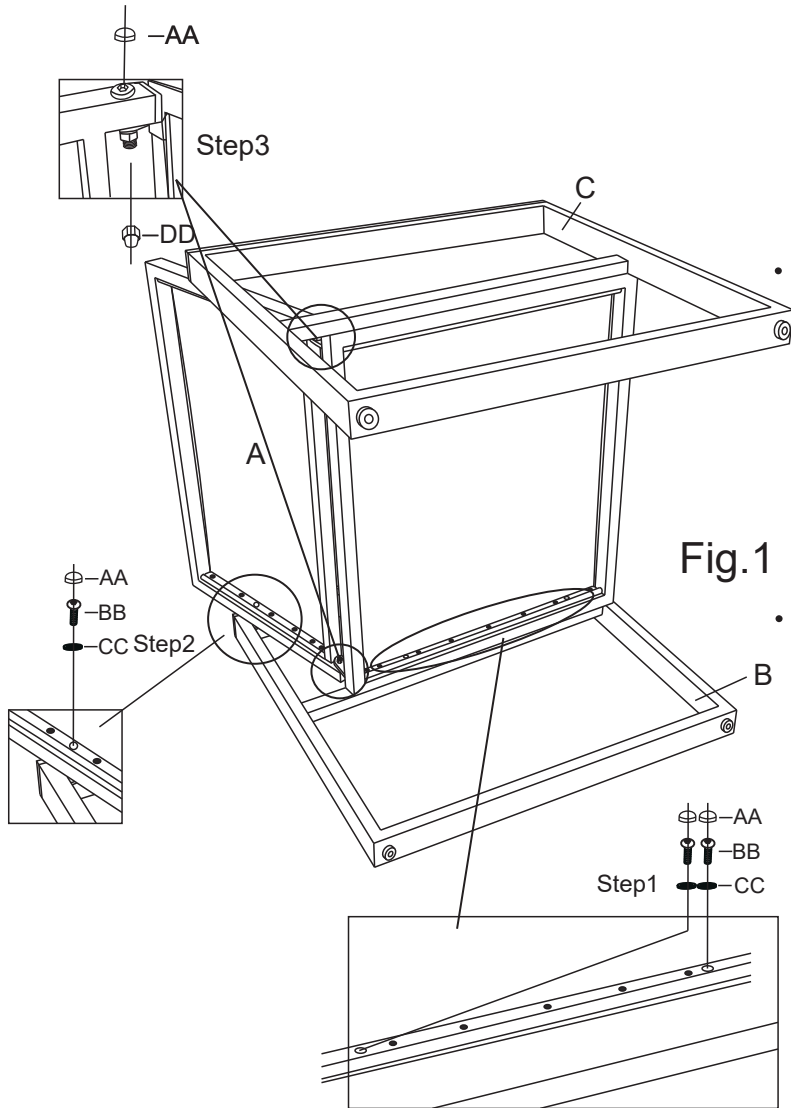

- STEP1: Attached ARM-L (B) and ARM-R(C) to SEAT&BACK (A) with washers (CC) and bolts (BB) using Allen Key (GG)

- Step2: Tighten BOLT CAPS(BB) with washers (CC) and using Allen Key (GG)

- Step3: Put bolt cap(AA) to all bolts and NUT CAP(DD) to the bolts at the SEAT&BACK(A) joints

2

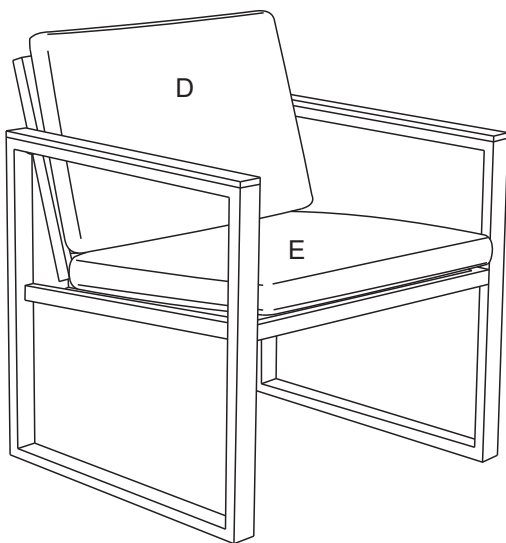

- Put Seat Cushion(E) and Back Cushion(D) on the chair

Natural Expressions

Faux Wood Armrest Conversation Set Loveseat & Coffee Table

Assembly Instructions

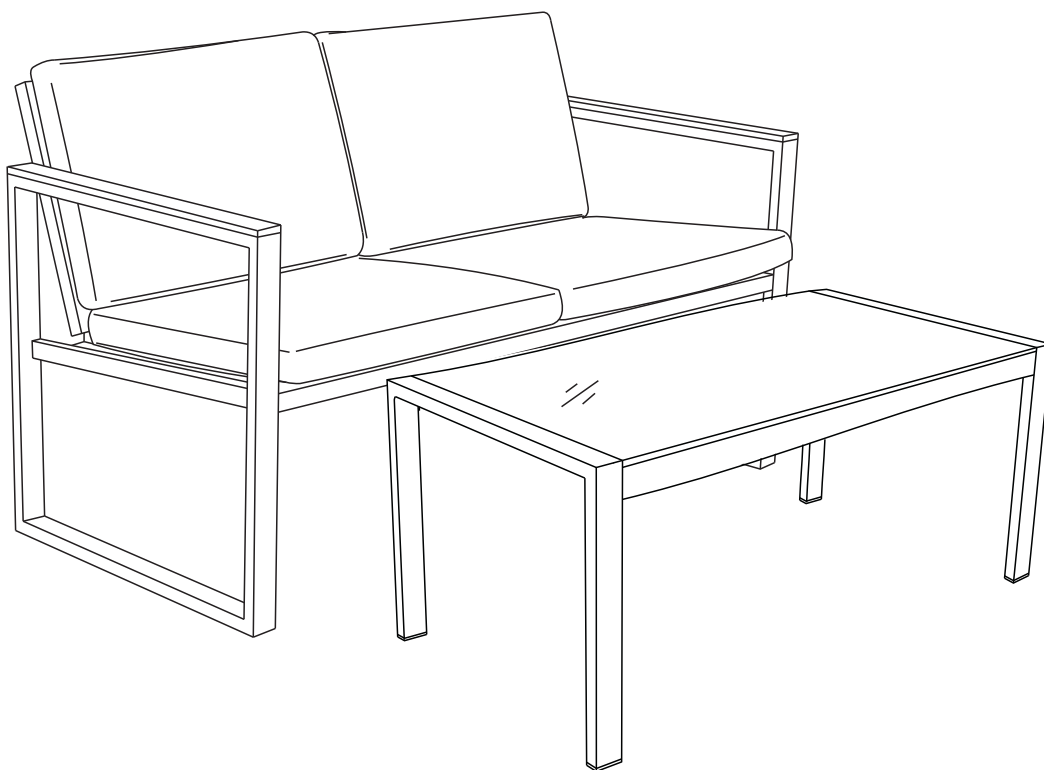

WARNING

- 1. This set is mixed packed into 2 boxes, please wait one more day if does not arrive on the same day*
- 2. Please confirm all parts correct before assemble*
- 3. Do not tighten fastening fully until assembly is complete*
- 4. DO NOT USE POWER TOOLS. Power tools can overtighten screws and strip threads*





If you have any questions ,feel free to contact us :





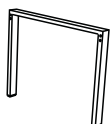
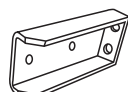
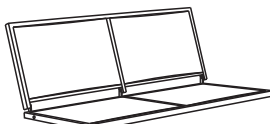
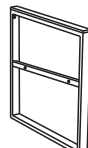
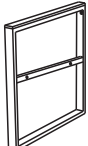

ne.us@topsunholdings.com

Tel : (317)334-0364 ext. 17

 **WARNING:** This product can expose you to chemicals including Di(2-ethylhexyl) phthalate (DEHP), which is known to the State of California to cause cancer, and birth defects or other reproductive harm. For more information go to www.P65Warnings.ca.gov.

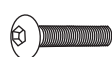
PARTS LIST

CODE	PARTS	QTY.
A	 GLASS	1PCS
B	 TABLE TOP	1PCS
C	 LEG	2PCS
D	 STEEL PANEL	4PCS
E	 SEAT&BACK	1PCS
F	 ARM-L	1PCS
G	 ARM-R	1PCS
H	 BACK CUSHION	2PCS
I	 SEAT CUSHION	2PCS

CODE	PARTS	QTY.
AA	 BOLT CAP(M6)	17PCS
BB	 BOLT CAP(M6*15)	16PCS
CC	 BOLT CAP(M6*35)	6PCS
DD	 WASHER(M6)	22PCS
EE	 NUT CAP(M6)	3PCS
FF	 ALLEN KEY	1PCS

1

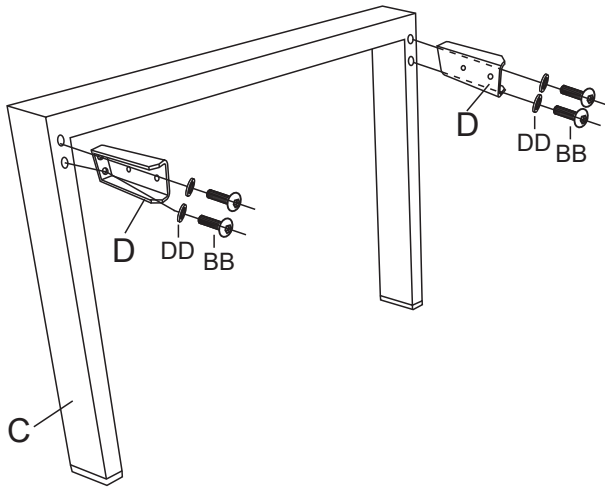

- Attached four STEEL PANELS (D) to two LEGS(C) with washers (DD) and bolts (BB) using Allen Key (GG)

2

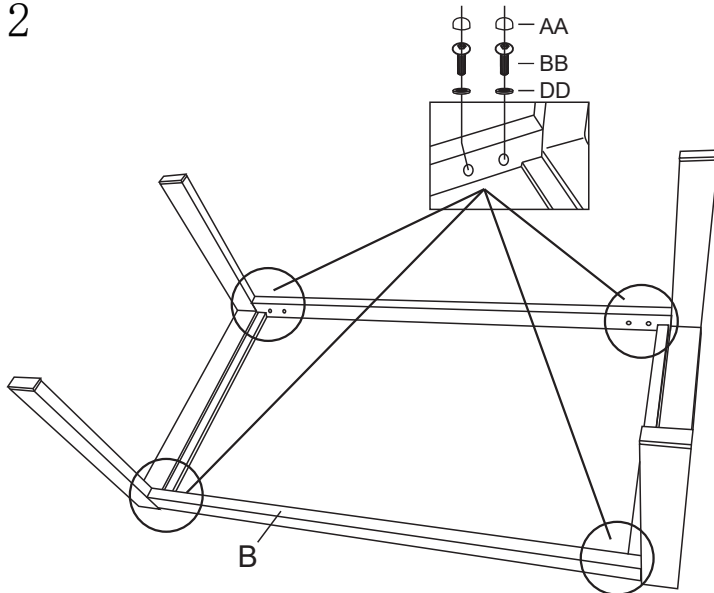

- Attached TABLE TOP (B) to Seat (C) with washers (DD) and bolts (BB) using Allen Key (GG)
- Tighten bolts using hex wrench and put bolt cap(AA) to all bolts

3

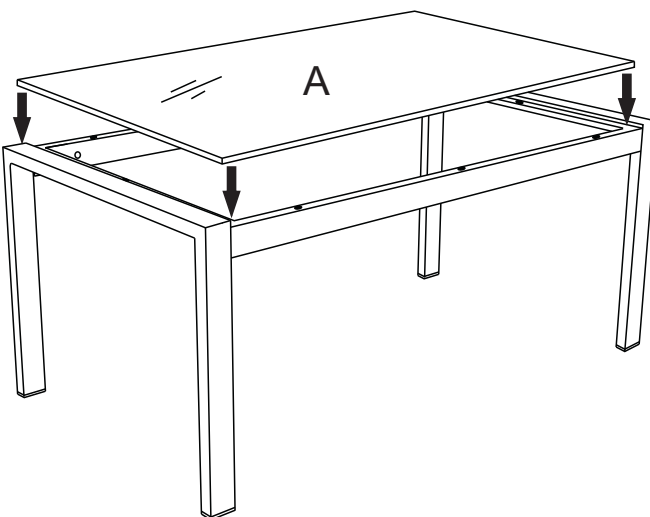

- Put GLASS (A) inside the TABLE TOP (B).

1

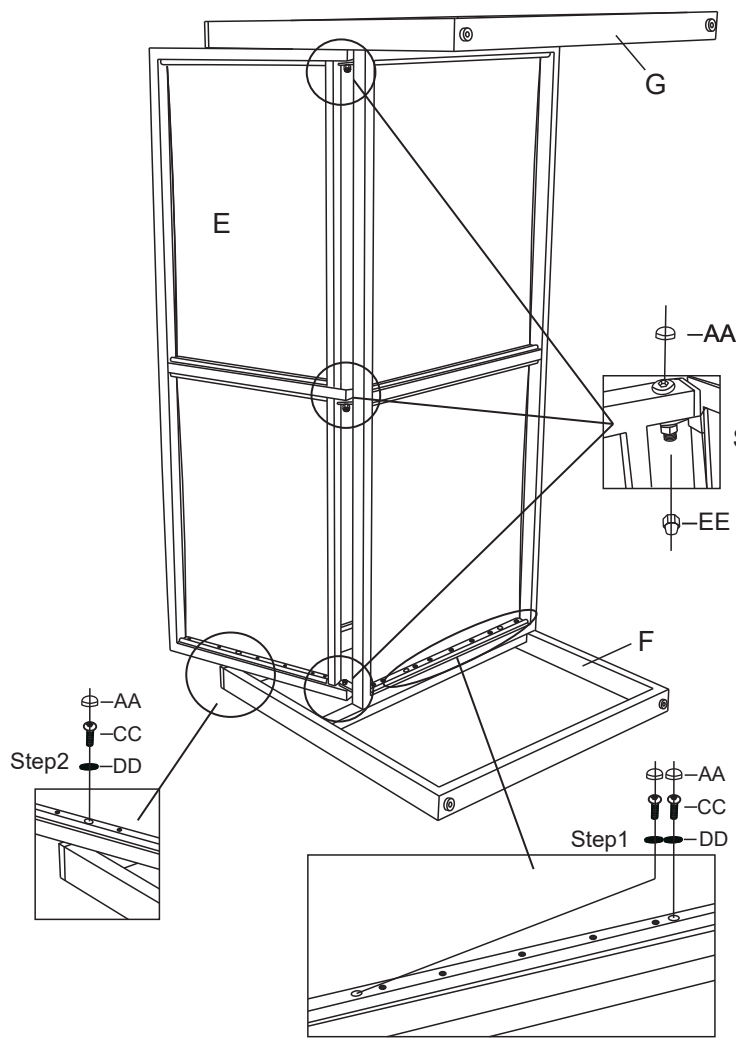

- STEP1: Attached ARM-L (F) and ARM-R (G) to SEAT&BACK (E) with washers (DD) and bolts (CC) using Allen Key (GG)

- Step2: Tighten BOLT CAPS(CC) with washers (DD) and using Allen Key (GG) and put bolt cap(AA) to all bolts

- Step3: Put bolt cap(AA) to all bolts and NUT CAP(EE) to the bolts at SEAT&BACK (E) joints

2

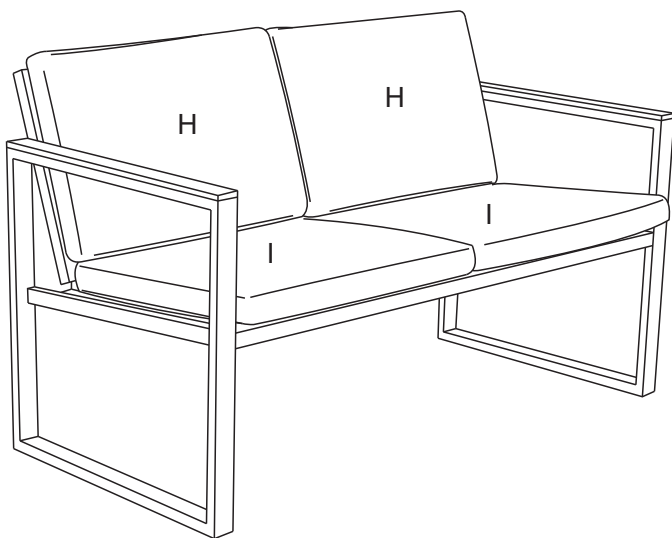

- Put Seat Cushion(I) and Back Cushion(H) on the loveseat

Natural Expressions

Thanks for choosing Natural Expressions, if you have any questions, inquires or suggestions, please contact us directly.

We will give our best services for you!

Customer service email: ne.us@topsunholdings.com

Attention: Products returned directly without permission will be rejected!