





# ASSEMBLY INSTRUCTION MODEL NO: Coffee table

## FITTINGS

NO:	PATTERN:	SIZE:	QTY:
A		M6×12	12
B		M6×35	4
C			1
D			2

### STEP 1

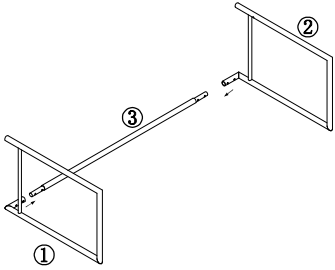

Connect the 117cm Rod (No.3) to Frames No.1 and No.2, and align the holes.

### STEP 2

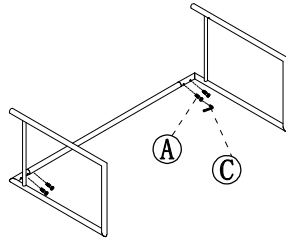

Use Wrench (C) and Screws (A) to secure Frames No.1, No.2 and No.3.

### STEP 3

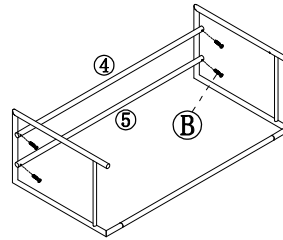

Use Screws (B) to fix the 123.5cm Rods (No.4 and No.5) on the inner side of the frame.

### STEP 4

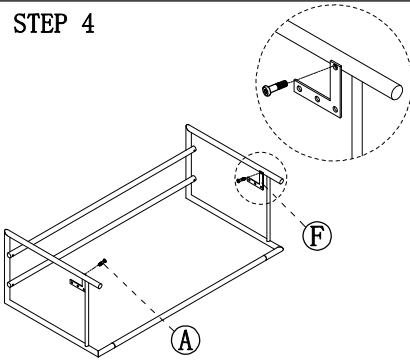

Use Screws (A) to secure Fitting (D). Note the installation direction of Fitting (D).

### STEP 5

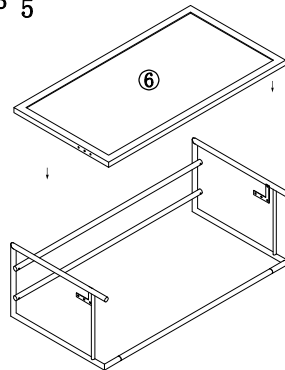

Place the Tabletop (No.6). Ensure the holes on the tabletop match those of Fitting (D).

### STEP 6

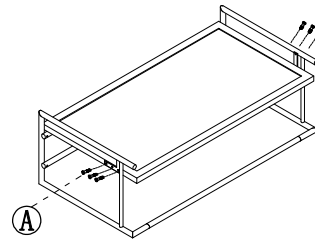

Use Screws (A) to secure Fitting (D) and the tabletop. For this step, align both ends evenly before tightening the screws.