

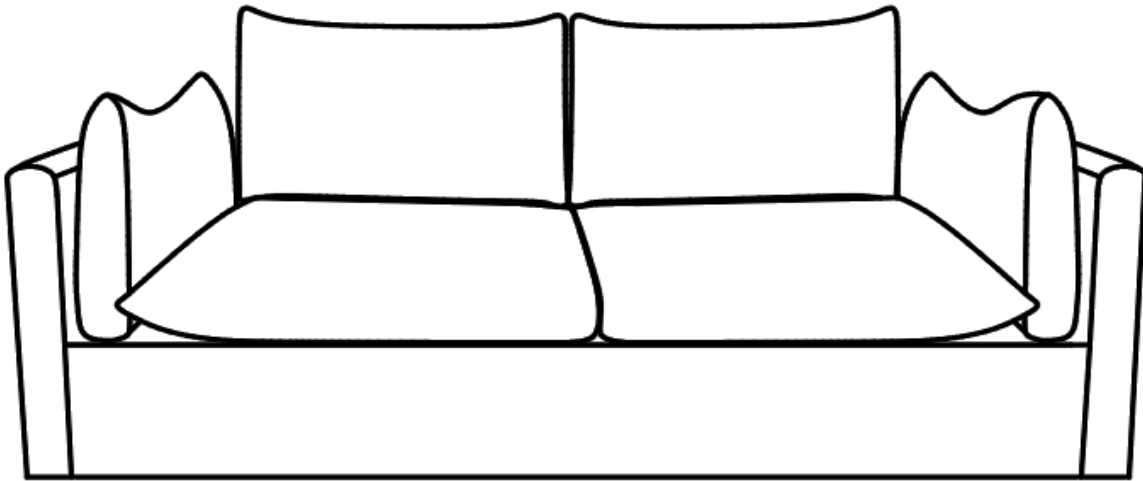

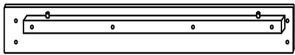

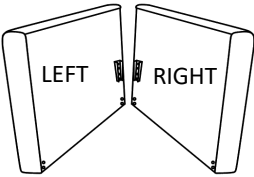





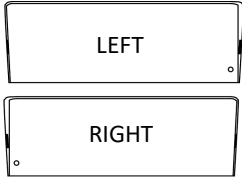

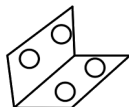

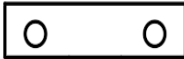
# ASSEMBLY INSTRUCTIONS

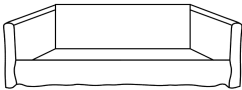

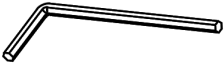
S P A R E  P A R T S	 <p><b>A*4</b></p>	 <p><b>B*2</b></p>	 <p><b>C*1</b></p>	 <p><b>D*2</b></p>
	 <p><b>E*2</b></p>	 <p><b>F*4</b></p>	 <p><b>G*1</b></p>	 <p><b>H*2</b></p>
	 <p>Cushion <b>I*2</b></p>	 <p>Pillow <b>J*4</b></p>	 <p>Sofa cover <b>K*1</b></p>	 <p><b>L*26</b></p>
	 <p><b>M*1</b></p>	 <p><b>N*26</b></p>	 <p><b>O*6</b></p>	 <p><b>P*6</b></p>

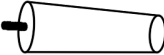
# Installation Steps

## STEP1

Install and connect the 4 baffles in parallel according to this drawing

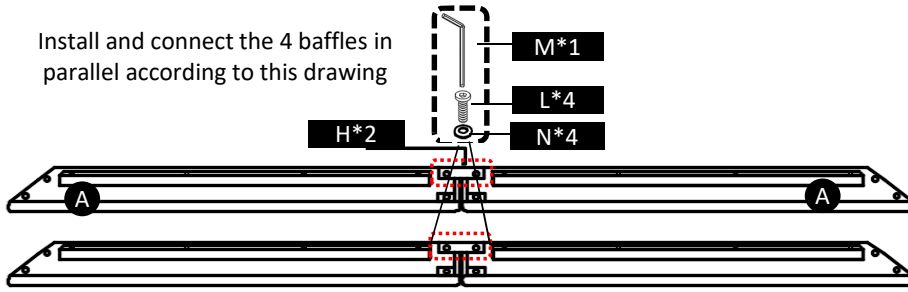

H\*2

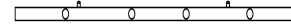
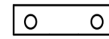

Keep the tip up and in the same direction as the other side

## STEP2

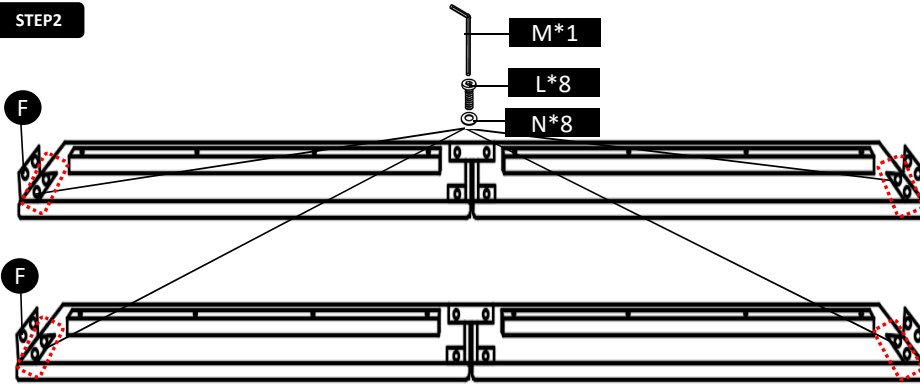

F\*4



Tighten the corner connector with bolts as shown here, and keep it parallel to the edge of the baffle

## STEP3

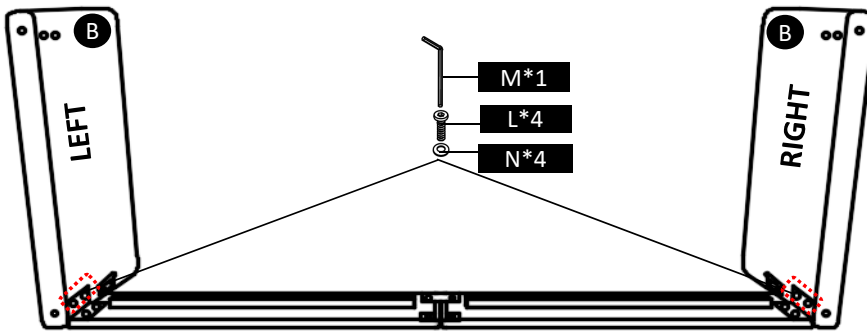

B\*2

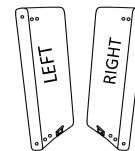

Tighten the bolts according to this drawing

## STEP4

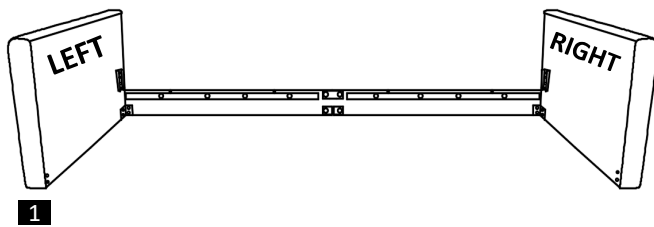

Flip the sofa as shown.

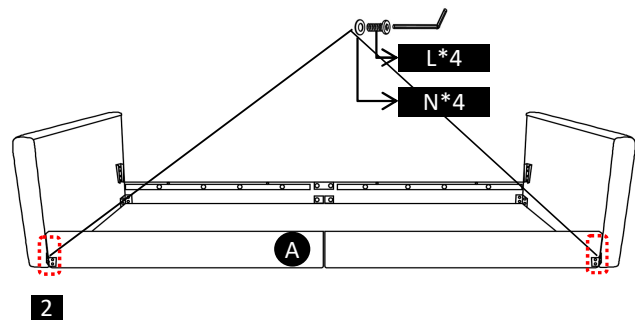

Align the connected baffle according to the drawing and tighten the bolts

# Installation Steps

STEP5

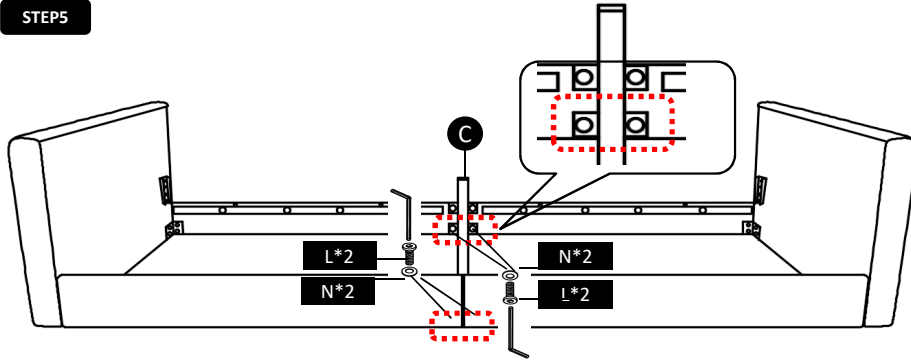

C\*1



Place the middle support of the sofa in the corresponding hole position according to this drawing and tighten the bolts.

STEP6

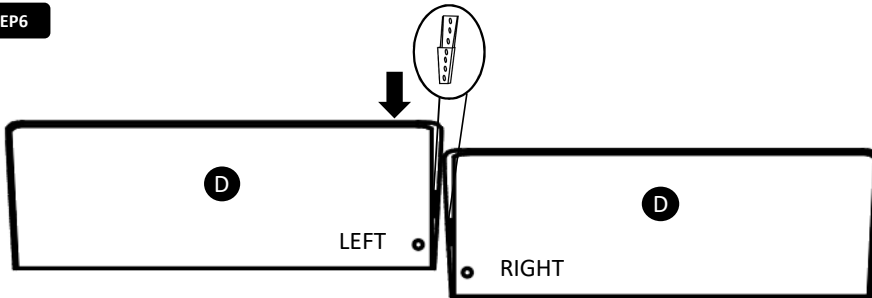

D\*2

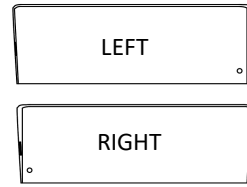

Insert the left and right backrest plates into the iron so that they are parallel up and down.

STEP7

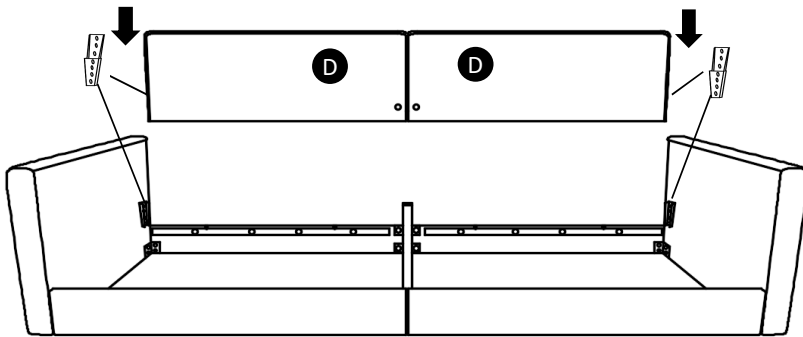

Insert the assembled backrest plate smoothly into the iron part according to the pattern.

STEP8

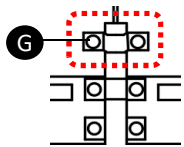

G\*1

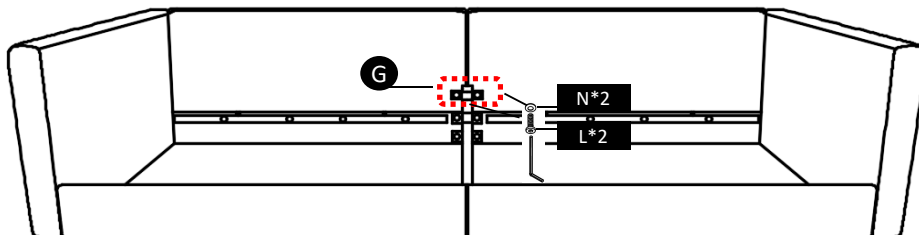
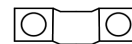

Bolt the backrest and the middle brace.

# Assemble

## STEP9

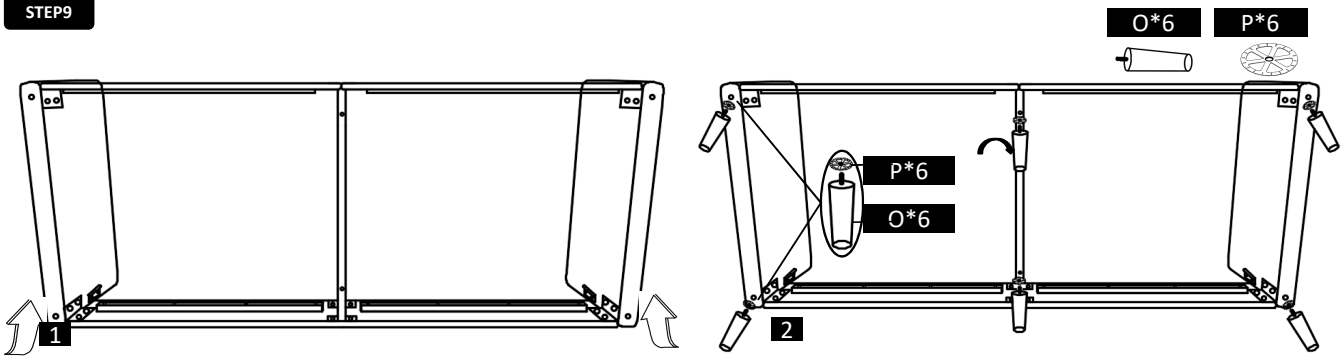

Turn the sofa up as shown and check again that the bolts are locked

Tighten 6 sofa feet separately

## STEP10

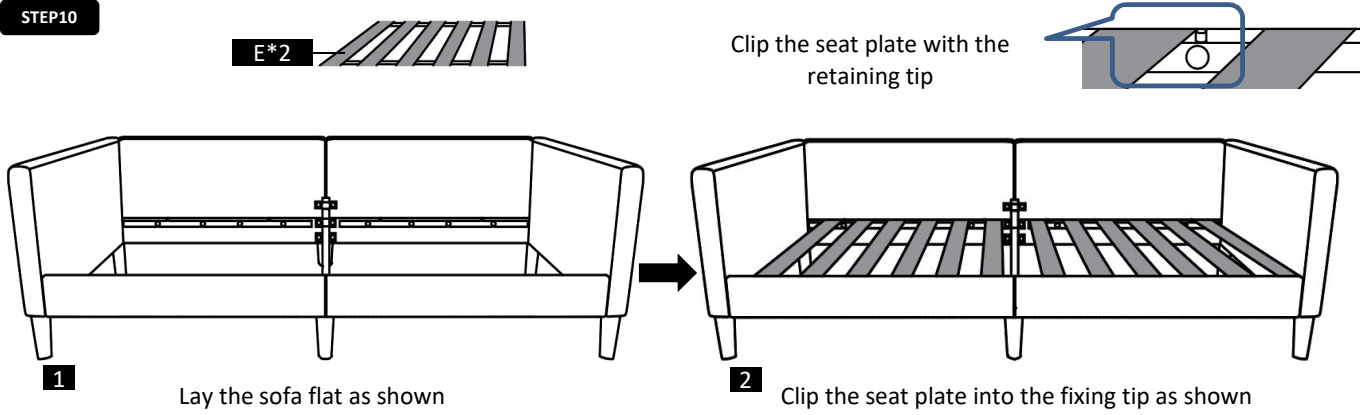

Lay the sofa flat as shown

Clip the seat plate into the fixing tip as shown

## STEP11

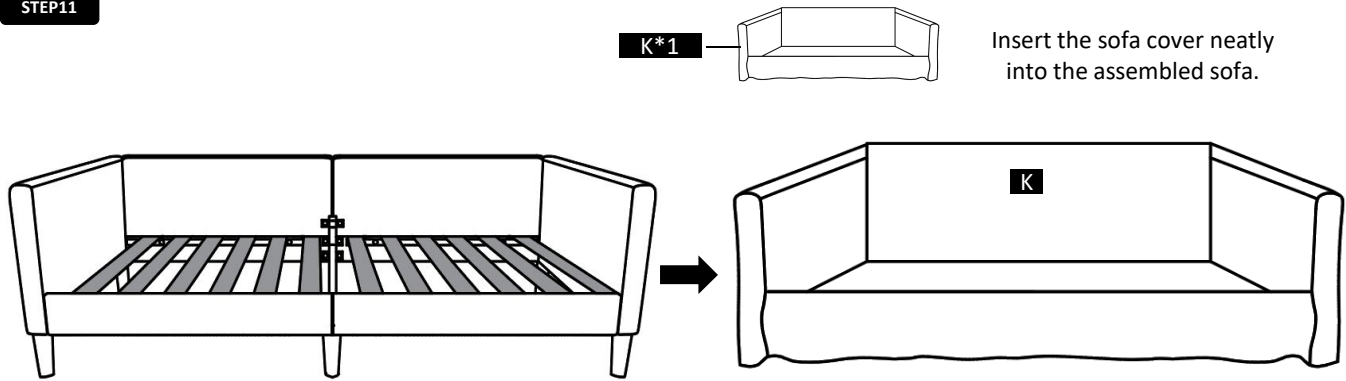

Insert the sofa cover neatly into the assembled sofa.

## STEP12

Place sofa hand pillows on both sides of armrests.

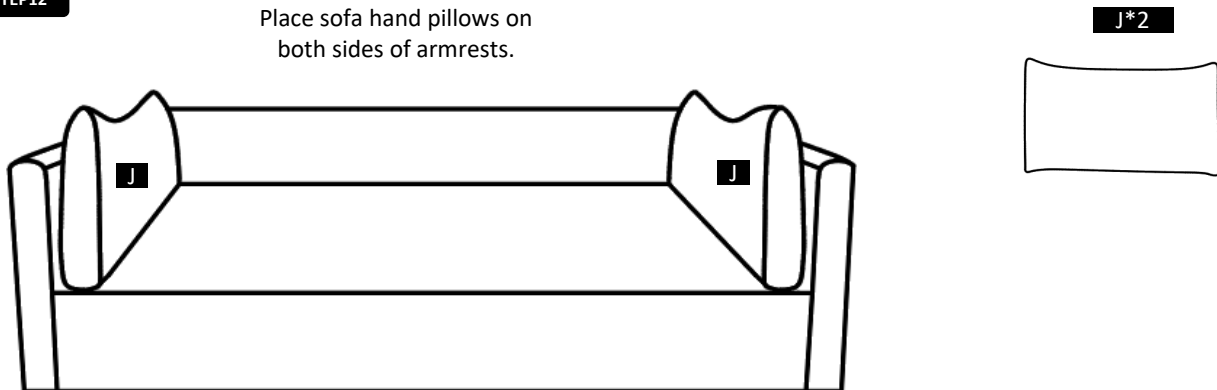

STEP13

Place the sofa cushion flat.

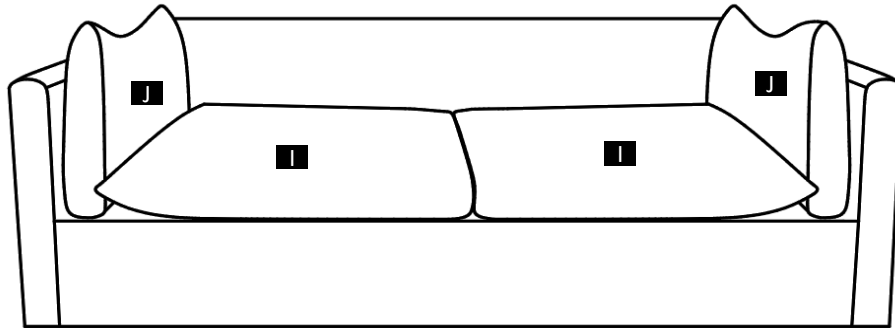

I\*2



STEP14

Place the sofa pillow flat.

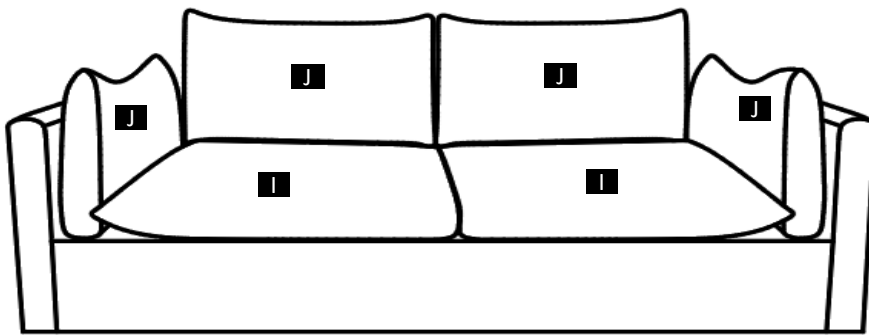

J\*2

