

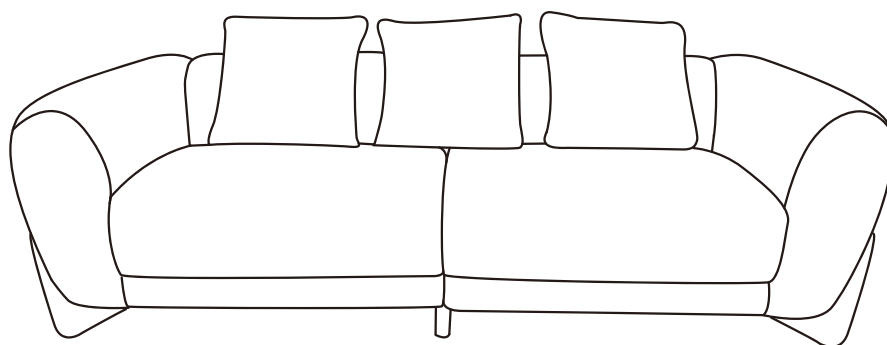

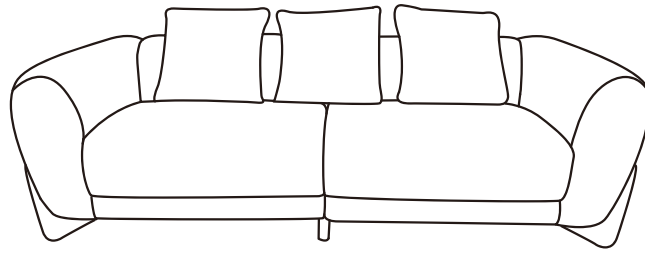

















ASSEMBLY INSTRUCTIONS



ASSEMBLY INSTRUCTIONS



ID	PARTS IDENTIFICATION	QTY	Carton	ID	HARDWARE PACKAGE	QTY
A1	 LEFT ARM	1 PC	ARM	①		2 PCS
				②	M6*20mm SCREWS 	9 PCS
③	M8*60MM SCREWS 	9 PCS				
④	ALLEN KEY 	1 PC				
⑤	3*22mm WASHER 	9 pcs				
⑥	MIDDLE LEG 	2 PCS				
⑦	M8*80MM SCREWS 	9 PCS				
⑧	M8 NUT 	9 PCS				
⑨	φ15mm SPRING SHIM 	9 PCS				
⑩	3*17mm WASHER 	9 PCS				
⑪	ALLEN KEY 	1 PC				
D	 PILLOW	3 PCS				
B1	 LEFT BACK FRAME	1 PC	S1-LAFCHAIR	⑫	 LEG	2 PCS
C1	 LEFT SEAT	1 PC				
B2	 RIGHT BACK FRAME	1 PC	S2-RAFCHAIR	⑫	 LEG	2 PCS
C2	 RIGHT SEAT	1 PC				

Step 1

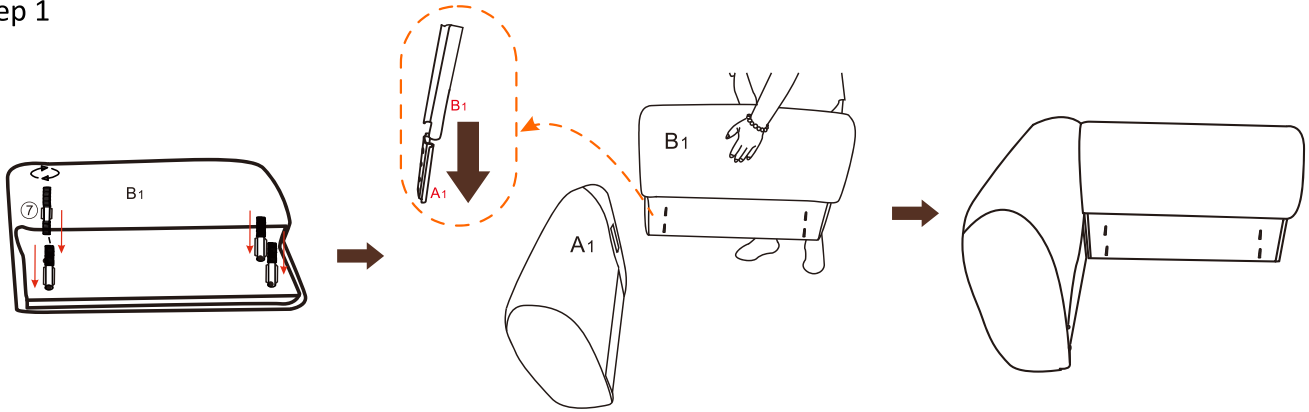

Step 2

Assemble the bench on soft, scratch-free surface such as a carpet or a rug. After the seat back screw was assembled, and tighten the screws with hex wrench

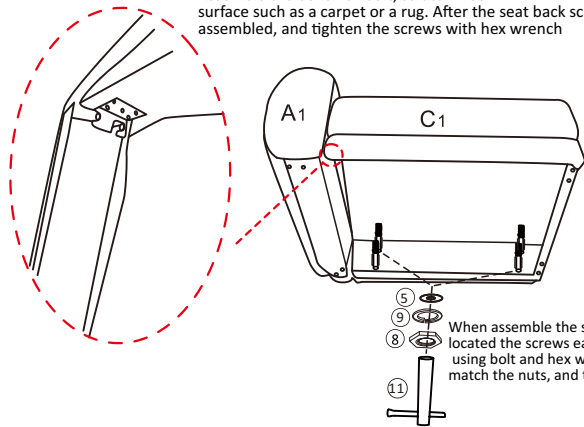

Step 3

When assemble the screws, fix the two diagonal screws first which can located the screws easier. Fasten the four screws to the seat cushion bottom using bolt and hex wrench 20% tighten first, ensure that the screws are match the nuts, and then tighten 100%

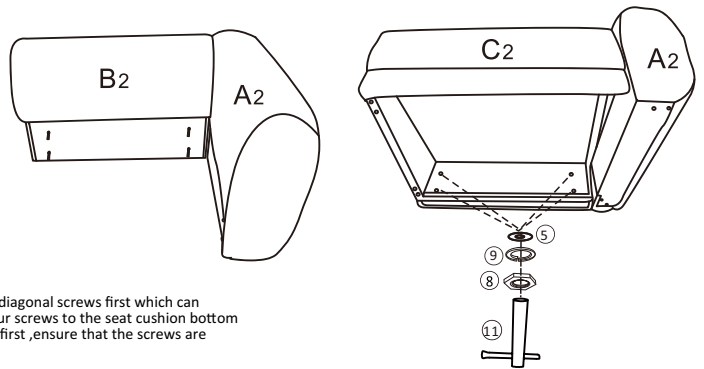

Step 4

Insert the bracket halfway first, and leave some space. After locating the position the screws, then fix the bracket firmly and tighten the screws.

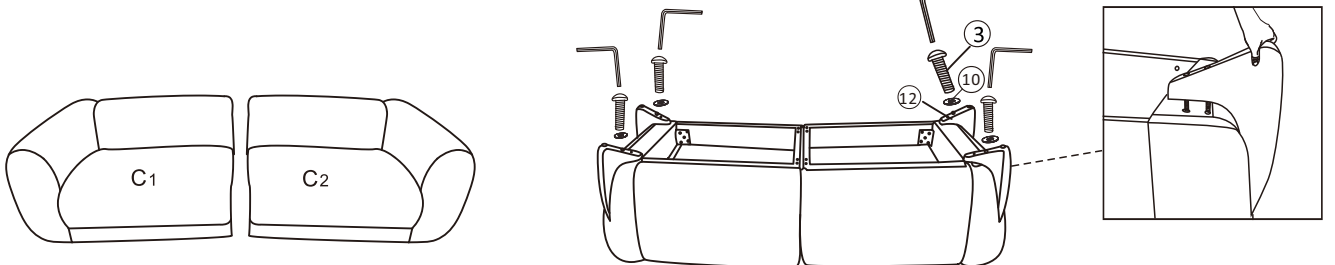

Step 5

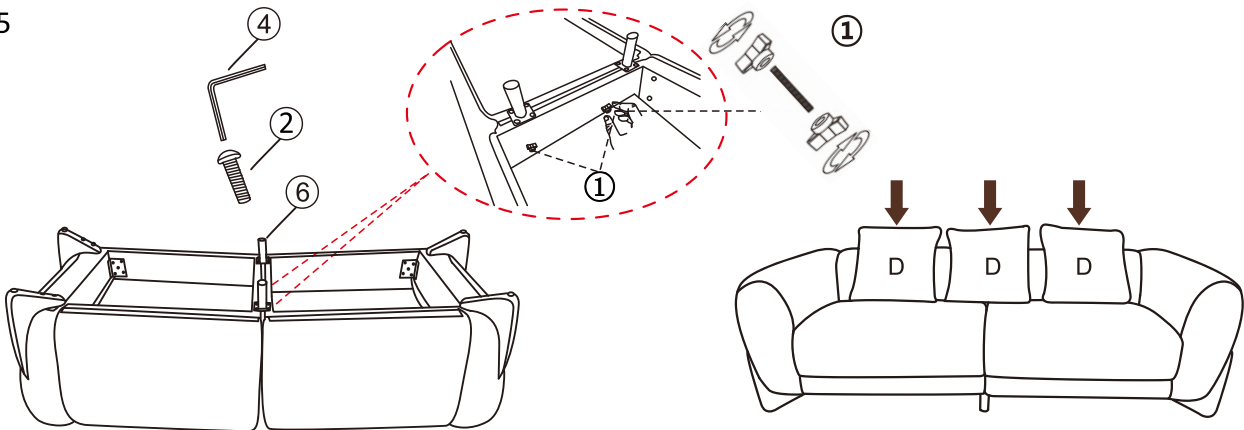

ITEM: CLOUD SOFA

ASSEMBLY INSTRUCTIONS

ASSEMBLY TIPS

1. Remove hardware from box and sort by size.
2. Please check to see that all hardware and parts are present prior to start of assembly.
3. Please follow attached instructions in the same sequence as numbered to assure fast & easy assembly.



WARNING!

1. Don't attempt to repair or modify parts that are broken or defective. Please contact the store immediately.
2. This product is for home use only and not intended for commercial establishments.

ASSEMBLY TIME: 15 MINUTES

