

BEVERAGE COOLER

User Manual

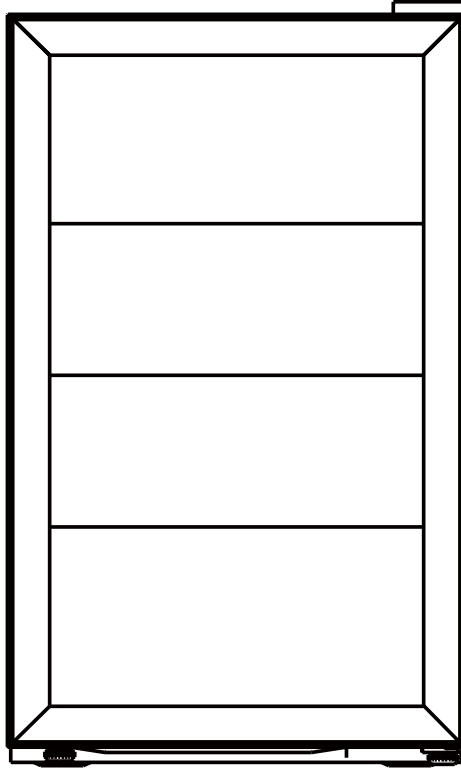

Model: NBYG-HA207B (JC-75VEL-F)

Please Read and Save this Use & Care Book

INSTALLATION

STOP

Follow the Instructions Below

Prior to Using the Beverage Center !

Do not plug the beverage center into a power outlet until it has been resting in its upright position for at least six (6) hours.

If the beverage center has been laid on its side, placed upside down or tilted more than 45° during moving or transport, it is extremely important to allow the refrigerant and compressor oil to separate and settle so the compressor operates properly. Failure to do so will cause severe mechanical problems with the unit's motor/compressor, and *will void the warranty*.

TRANSPORT

Use two or more people to move the beverage center.

Do NOT use stainless steel handle to move or lift the unit.

VENTILATION SPACE

In order for the beverage center to function efficiently, it **MUST** be placed in an adequately ventilated space to allow for heat dissipation. It is important to allow at least 2 inches (50 mm) of space on each side and above the unit, and 4 inches (100 mm) of space behind the unit.

The door requires approximately 22 inches (558 mm) of space in front of the beverage center to open. To fully utilize the unit, space should be allowed for the door to open fully to 160°.

STABLE SURFACE

The beverage center must be placed on a flat, stable surface. Adjust the unit's front leveling legs to assure quiet operation and prevent rattling when the compressor activates.

IMPORTANT:

- Never place the unit on soft materials such as foam, plastic or thick textured carpeting.
- Make sure the unit and door are aligned. Use the adjustable legs (front only) to align the unit and/or the screws under the triangular bracket cover to align the door. See page 6 for more detailed instructions on accessing the metal bracket.

Parts and Features

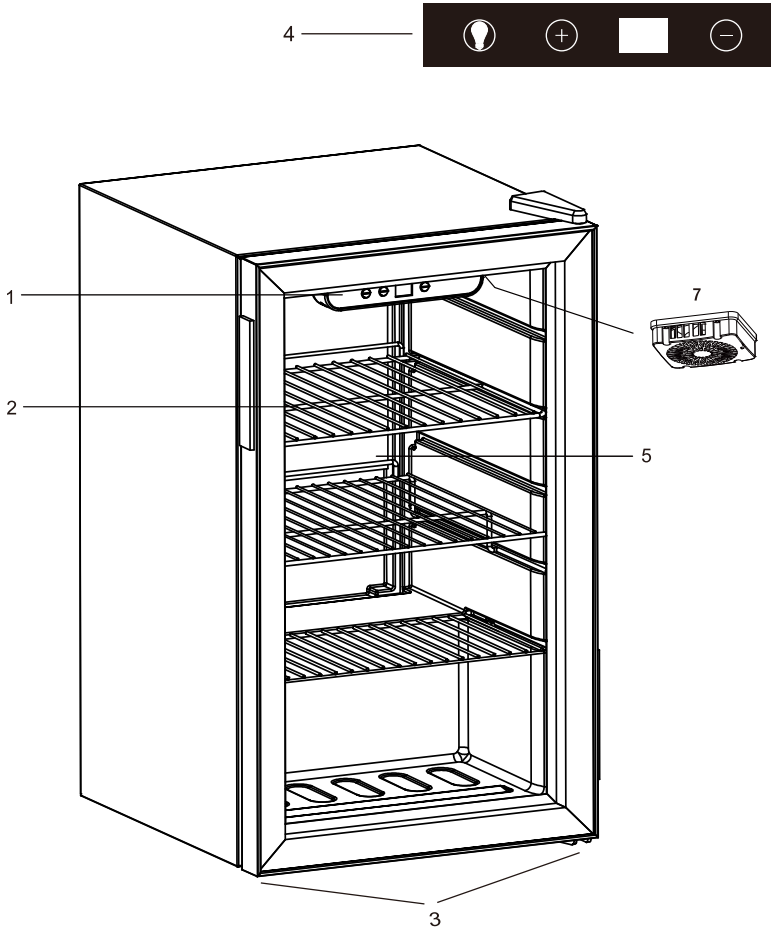

- 1. Interior Light
- 2. Wire Shelves (3)
- 3. Adjustable Leveling Legs
- 4. Touch Control Panel

- 5. Tinted Double Pane Glass Door
- 6. Drip Tray in Back (not shown)
- 7. Fan

INSTALLATION

POWER SUPPLY

This beverage center is equipped with a 115V/60Hz single phase motor. Do not use a ground-fault circuit interrupter (GFCI) outlet to connect the unit. (Fig. A.)

Fig. A



The power plug is a standard grounded three-prong non-polarized flush mount, which allows for easier connection to power outlets.

Power plug must be connected to the outlet directly, and never to an extension cord.

IMPORTANT: Do not cut or remove the third ground prong from the power cord.

POWER CORD

Never shorten or lengthen the power cord. Do not fold or coil the power cord.

IMPORTANT - Never place the excess length of power cord into the compressor enclosure in the back of the beverage center. This action creates a dangerous heat build-up which can melt the cord, cause an electrical hazard and may potentially cause a fire.

Touching the power cord to the compressor at the back of the unit during operation can create an electrical hazard and damage the compressor.

If the power cord is damaged, it must immediately be replaced by a trained service provider, as special tools are required.

CLEAN BEFORE USE

IMPORTANT: Never use with an extension cord. Power cord length is 5 feet long (1524 mm).

To remove any manufacturing dust and residual odors, wipe the beverage center inside and out with a damp cloth and a solution of baking soda and warm water (2 tbsp. baking soda to 1 qt. water). Wipe away any residual baking soda with a clean moist cloth. Allow to dry before operating.

Periodically clean the beverage center with a sponge or cloth moistened with mild soapy water, or baking soda and water.

PROTECT FROM MOISTURE

Heavy moisture in the environment can cause degradation to the insulation, as well as rust to the cabinet, compressor and / or power supply.

Do not spray the beverage center with water.

PROTECT FROM HEAT

Place the beverage center away from heat source or direct sun.

Do not operate your beverage center outdoors or in an environment with high temperatures and / or high humidity, such as garages, attics or outdoor patios. The temperature variances will create condensation on the glass door.

Do not cover the beverage center with tarps or other items while operating, as this may cause overheating.



INSTALLATION

USING YOUR BEVERAGE CENTER



Startup

Connect the power cord to a standard wall outlet. Do not use a GFCI outlet to connect the unit (see page 4). After connection, you will immediately hear a short beep.

Temperature - Adjustable Thermostat Control

The default temperature is 43°F. Use the  and  buttons to set the desired temperature between the range of 37°F - 61°F.

The display will flash while the temperature is being set. After a few seconds, it will revert to its current internal temperature reading. The digital display reading will adjust as the unit cools.

While the unit is adjusting to the new setting, press the  or  buttons to view the selected temperature setting.

If there is a power outage, the unit will revert to the last temperature setting once power is restored.

Loading Beverages

When first loading the beverage center to full capacity, we recommend the following steps to effectively cool a large number of beverages.

1. Use the Adjustable Thermostat Control to set the temperature to 43°F (also the default temperature).
2. Allow the beverage center to cool for a minimum of two hours.
3. Load the beverages. To achieve maximum capacity, refer to the loading diagrams.
4. After initially filling with beverages, the internal temperature will rise as indicated on the display.
5. Once the beverage center has cooled the beverages to 37°F, use the Adjustable Thermostat Control to select a desired cooler internal temperature (lowest temperature setting is 37°F).
6. Allow several hours for the beverage center to cool to the desired lower temperature.

Note: It is normal for temperature variances to occur inside the unit, and areas near the door will have slightly warmer temperatures.

INSTALLATION

LED LIGHT

Press the  button to turn the LED light on and off.

To enhance the lifespan of the LED light and conserve energy, it is recommended to predominantly utilize the light for loading and selecting beverages.

SHUTDOWN

If the beverage center will not be in use for a long period of time, disconnect it from the power outlet, clean inside thoroughly and leave the door open to prevent mildew.

SAFETY WARNING

The appliance is not intended for use by young children or infirm persons without supervision. Young children should be supervised to ensure that they do not play with the appliance.

This beverage center should not be positioned within a recessed or enclosed cabinet. It is designed for freestanding installation only. This unit is not designed to be installed in a RV, garage or any outside installation.

The surface of the compressor may become hot during normal operation. Do not touch as this may cause injury.

OTHER DANGERS

Keep the beverage center away from any combustible or volatile liquids or gases, including gasoline, oil, alcohol, paint, paint thinners and solvents. Such chemicals should never be stored in the unit.

DEFROSTING

Frost may develop on the interior back panel of the unit when the temperature setting is very low and the unit is not fully stocked with beverages. The presence of frost may force the unit to run continuously and thus increase internal temperature.

To defrost the beverage center:

1. Use the \oplus and \ominus buttons to increase the temperature until the compressor turns off.
2. Allow the internal ice/frost buildup to melt. Ensure the internal drain (located at the middle back of the lower shelf) is not clogged.
3. During this time, the melted frost flows through an internal drain into a holding pan on top of the compressor. The heat of the compressor evaporates the liquid.
4. Reset the temperature to 32°F and allow to cool for at least one hour.
5. Adjust to the desired temperature setting

CLEANING AND MAINTENANCE

It is important to periodically clean and maintain the beverage center. When performing maintenance, make certain the unit is unplugged from the power outlet.

Wipe the inner and outer surfaces of the beverage center clean with a damp cloth. If needed, use a gentle detergent or a solution of baking soda and water. Remove any residue with clean water and a soft cloth, then dry with another cloth.

Once clean, you may use a common kitchen appliance wax on outer surfaces.

Inspect, clean and maintain the rubber gasket around the door. A small amount of petroleum jelly applied to the bracket side of gaskets will keep the gasket pliable and ensure a good seal.

IMPORTANT:

- Do NOT use hot water, harsh detergents, gasoline, kerosene, solvents, acids or anything flammable to clean the beverage center. These can damage the paint and degrade the plastic components.
- Do NOT spray the beverage center with water as this may cause rust and degrade the insulation.
- Do NOT clean glass shelves with hot water when they are cold. Shelves may break if exposed to sudden temperature changes or impact. For your protection, tempered glass is designed to shatter into many small pebble-size pieces.
- If any replacement components are required, they must be obtained from Tramontina's Customer Service Department. This ensures the correct replacement components are provided, and minimizes risk of possible ignition due to incorrect parts or improper service.

TROUBLESHOOTING

Problem	Recommended Adjustment
The beverage center doesn't work.	<ul style="list-style-type: none"> • Check for power failure. • Verify unit is plugged into a standard power outlet and not a GFCI outlet (<i>see page 4</i>). • Check if control panel is on.
The beverage center is too cold.	<ul style="list-style-type: none"> • Adjust thermostat to higher number.
The beverage center is not cooling sufficiently.	<ul style="list-style-type: none"> • Adjust thermostat to lower number. • Ensure door is closed properly. • Ensure the door gasket provides a proper seal. If you can slide a piece of paper between the gasket and unit body, the gasket is not sealing properly. • Unit may not have enough ventilation space around it. • Check if the sides of the unit are warm. If not, please contact Customer Service Department. • Do not put hot beverages in the beverage center.
The beverage center compressor runs for long periods.	<ul style="list-style-type: none"> • Hot weather and/or frequent door opening will force the unit to work harder to keep cool. • Do not overload the beverage center. • Do not put hot beverages in the beverage center.
The beverage center door does not close properly.	<ul style="list-style-type: none"> • Unit may be tilted – adjust front legs to level unit. • Align the door using a 5/16" (8 mm) socket, adjusting the screws under the triangular bracket cover. For assistance, please contact Customer Service Department.
Side panel of beverage center is hot.	<ul style="list-style-type: none"> • The unit exchange heats through the side walls, therefore does not indicate malfunction. • Usually happens when door is opened and closed frequently, or when operated in high temperature weather. Results from dissipation of heat from within the unit. Do not touch the panel. Does not indicate a malfunction.
Condensation forms on the glass door	<ul style="list-style-type: none"> • Condensation forms under conditions of high humidity; does not indicate a failure. Wipe condensation with dry towel. • Relocate unit to a cooler area or adjust thermostat to a higher setting to balance out the exterior and interior temperatures. Condensation will dissipate as time goes on.
Sound of trickling water.	<ul style="list-style-type: none"> • This is the refrigerant flowing. Does not indicate a malfunction.
Buzzing sound.	<ul style="list-style-type: none"> • A buzzing noise is typically generated by the compressor when starting up or shutting down.
Odor.	<ul style="list-style-type: none"> • Unit may require cleaning.

SAFETY WARNINGS

Before you use your beverage center, please read this owner's manual carefully. Use this appliance only for its intended purpose as described in this owner's manual.

DANGER - Risk of child entrapment. Before you throw away your old refrigerator or freezer:

- Take off the doors.
- Leave the shelves in place so that children may not easily climb inside.
- The appliance must be correctly installed and connected to the power supply in accordance with the installation instructions before it is used.. (See: "HOW TO INSTALL").
- The main power supply must be properly grounded.
- This beverage center must be positioned so that the plug is accessible. Never unplug the unit by pulling on the power cord. Always grasp the plug firmly and pull straight out from the outlet.
- Do not use an extension cord as this can negatively affect the performance of the unit.
- When transporting the beverage center, keep the unit in the upright position. Do not tilt the appliance beyond 45° or place the unit in upside down position. Do not tip over.
- Do not touch the cooled surfaces while the appliance operates, especially not with wet hands, because the skin may stick to the cold surfaces.
- It is recommended that the beverage center is positioned away from any combustible sources, such as gas, petrol, alcohol, lacquer and banana oil, etc. The aforementioned objects should not be stored in the beverage center under any circumstances.
- If the unit fails to cool properly, dispose of spoiled food as needed.
- Unplug your unit before cleaning or making any repairs. NOTE: If for any reason this product requires service, we strongly recommend that a certified technician perform the service. Repairs made by non-qualified personnel will void the warranty.
- Do not defrost the appliance with other electrical devices (hair dryer, etc.), and never scrape the ice or frost layer with sharp tools. Warning: Do not damage the refrigerant circuit.
- The rating plate is inside the appliance or outside on the rear or side wall.
- This appliance is not intended for use by persons (including children) with reduced physical, sensory or mental capabilities, or lack of experience and knowledge, unless they have been given supervision or instruction concerning use of the appliance by a person responsible for their safety. Children should be supervised to ensure that they do not play with the appliance.
- Do not run cord over carpeting or other heat insulators. Do not cover the cord. Keep cord away from traffic areas, and do not submerge in water. If the supply cord is damaged, it must be replaced by the manufacturer or its service agent or a similarly qualified person in order to avoid a hazard. Repair or replace immediately all electric cords that have become frayed or otherwise damaged. Do not use a cord that shows cracks or abrasion along its length, the plug or the connector end.
- Do not operate your beverage center in the presence of explosive fumes.
- WARNING – Do not use flammable materials on or near the unit. This can result in fire and cause irreparable harm or damage to the unit.
- DANGER – Risk of Fire or Explosion. Flammable Refrigerant Used. To Be Repaired Only By Trained Service Personnel. Do Not Puncture Refrigerant Tubing.
- CAUTION – Risk of Fire or Explosion. Dispose of Property In Accordance With Federal or Local Regulations. Flammable Refrigerant Used.
- CAUTION – Risk of Fire or Explosion. Flammable Refrigerant Used. Consult Repair Manual/ Owner's Guide Before Attempting to Service this Product. All Safety Precautions Must be Followed.
- CAUTION – Risk of Fire or Explosion Due to Puncture of Refrigerant Tubing; Follow Handling Instructions Carefully. Flammable Refrigerant Used.

SAFETY WARNINGS

REMOVE BEVERAGE CENTER DOOR BEFORE DISPOSING OF UNIT.

SUFFOCATION HAZARD:

The shelves should remain in the beverage center for disposal. This deters children from climbing into the unit, becoming trapped and potentially suffocating.

All safety precautions must be followed.
