

## THANKS FOR WATCHING

Your feedback is invaluable to us and we would love to hear about your experience. Please take the time to leave us a review.

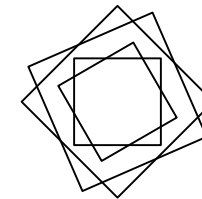

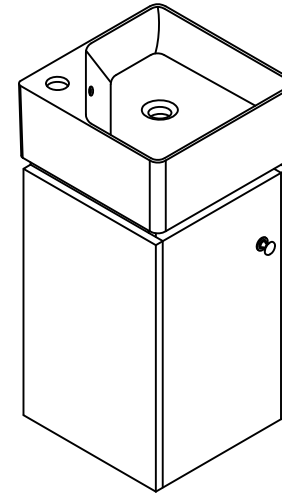













## Thank you for shopping with us!

We encourage you to take a few minutes to go through this booklet. It contains important information on installation and care tips to keep your furniture looking as good as new.

# Item NO.:BV C4512

## Hardware

NO.	Draw	QTY	NO.	Draw	QTY
A	 Screws Ø4x14mm	32	I	 Hinges	2
B	 Two-in-one connector	14	J	 Handle	1
C	 Two-in-one connector	14	K	 Screws M4x18mm	1
D	 Wood plug	6	L	 Anti-collision gasket	2
E	 Plastic anchor(Ø10mm)	4	M	 Screws Ø4x25mm	6
F	 Screws for fix on the wall	4	N	 Screwdriver	1
G	 Bracket (53x70x44mm)	2			
H	 Bracket (19x19x35mm)	2			

## Recommended tools

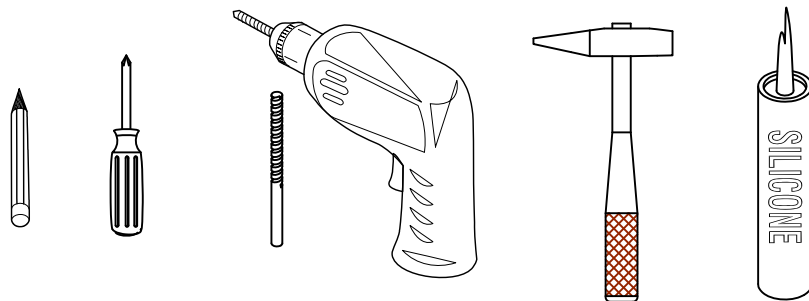

## Dimensions

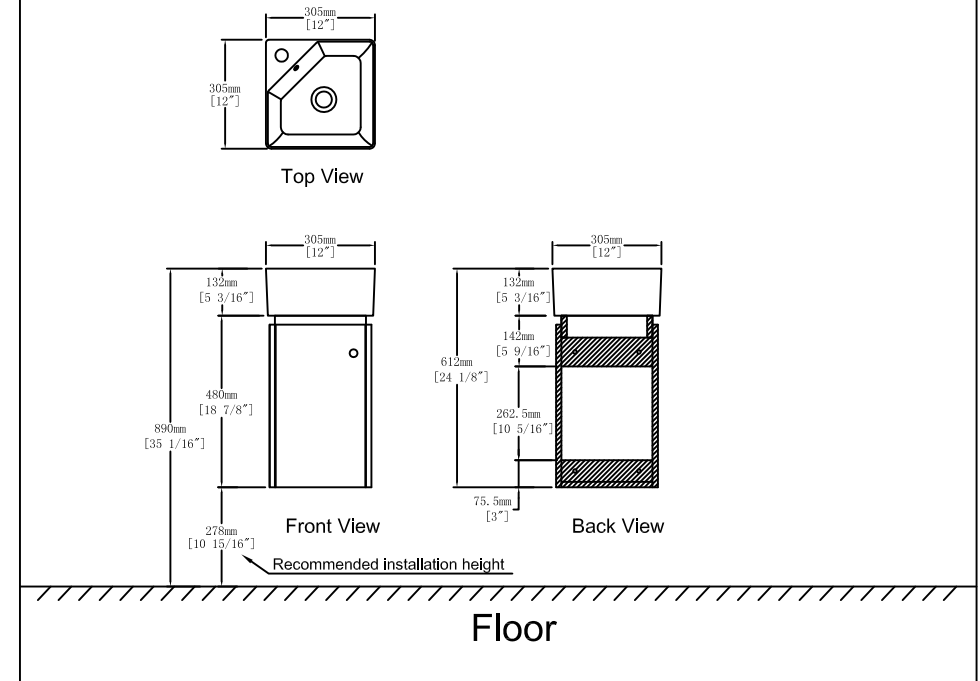

## CARE CLEANING AND MAINTENANCE

1. Dust regularly with a soft , dry cloth.
2. Avoid the use of all chemicals household cleaners, abrasives, or cleaners that contain lemon, vinegar, or other acids that may damage the finish.
3. Excessive exposure to sunlight and extreme changes in temperature and moisture can damage wood furniture.
4. The sink top is resilient, but care needs to be taken to preserve its appearance.
5. Do not place hot appliances, such as curling irons and hot hair dryers directly on the countertop. Wipe spills immediately.

Step 13

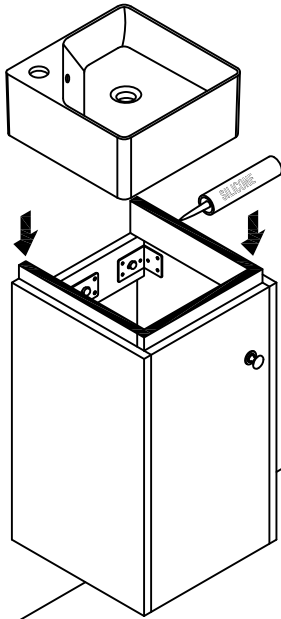

Dimensions

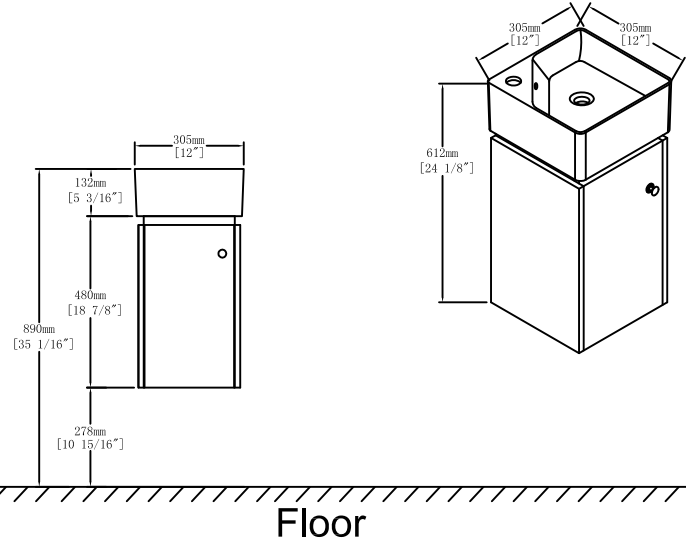

Finished

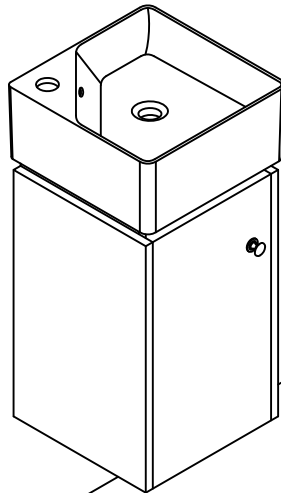

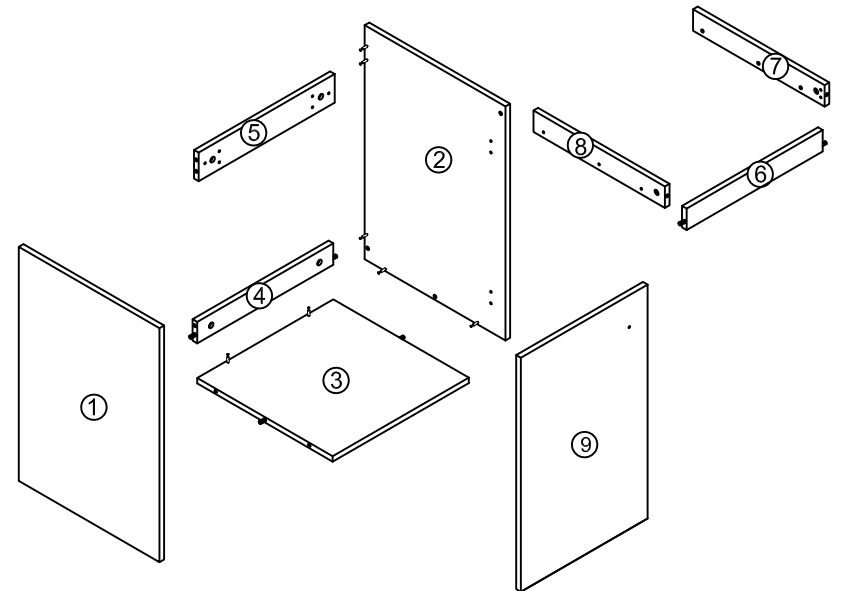

Components

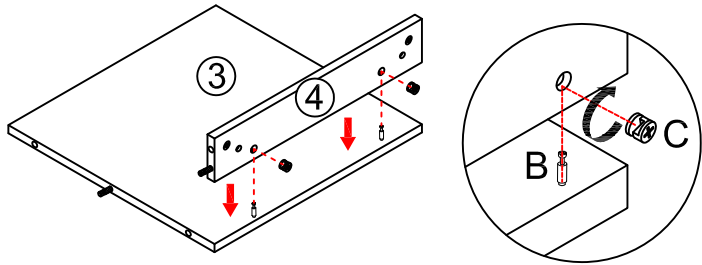

### Step 1



-  x2
- B**
-  x2
- C**
-  x1
- N**

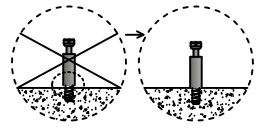
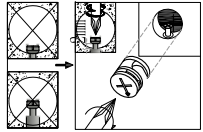

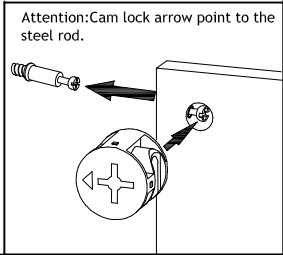

Notes: Screw installation depth as shown

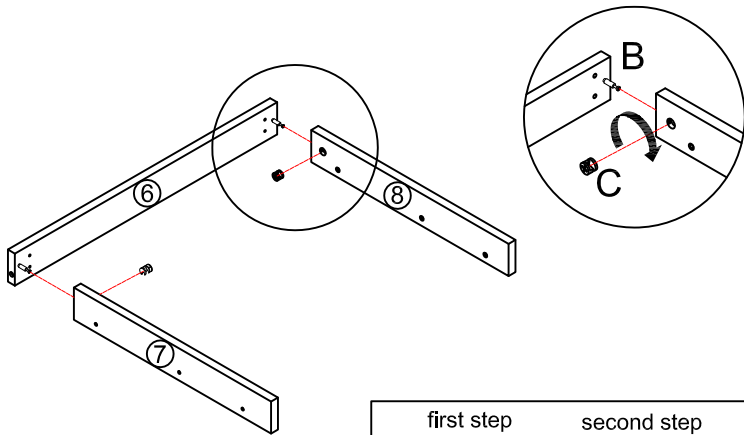

### Step 2



-  x2
- B**
-  x2
- C**
-  x1
- N**

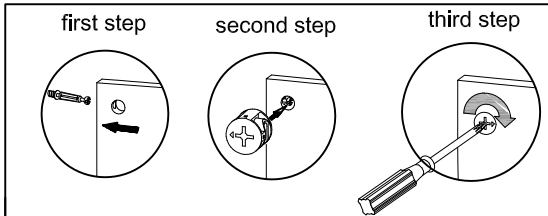

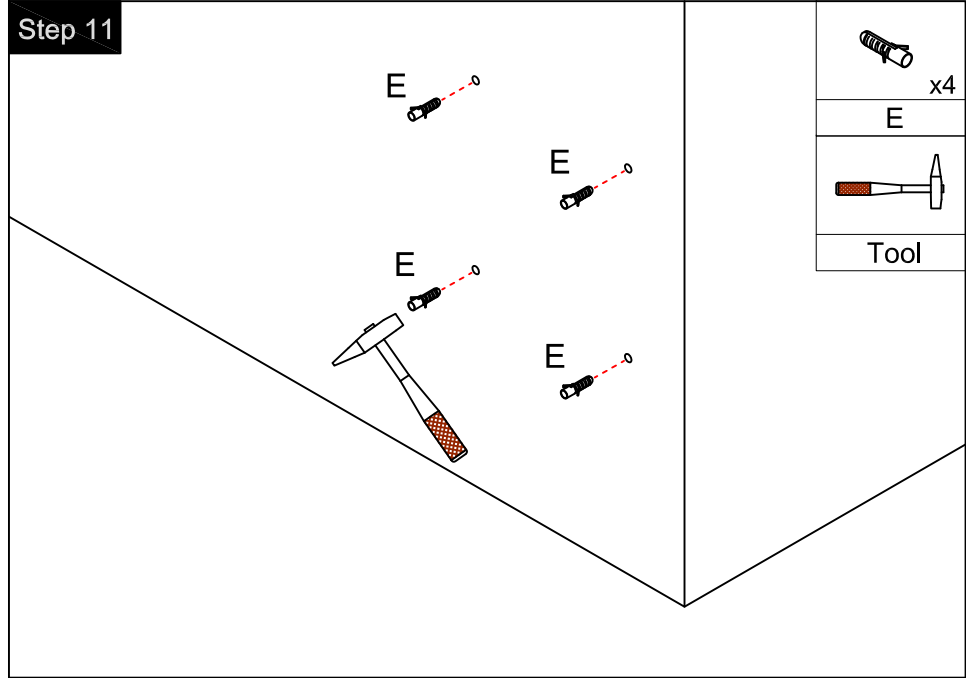

### Step 11

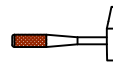

-  x4
- E**
- 
- Tool**

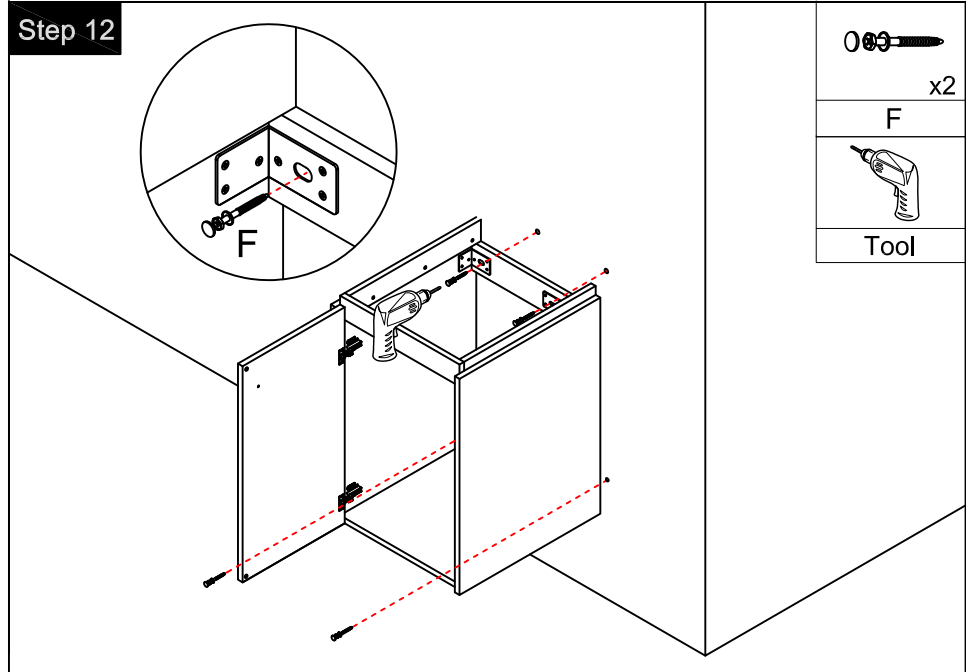
### Step 12









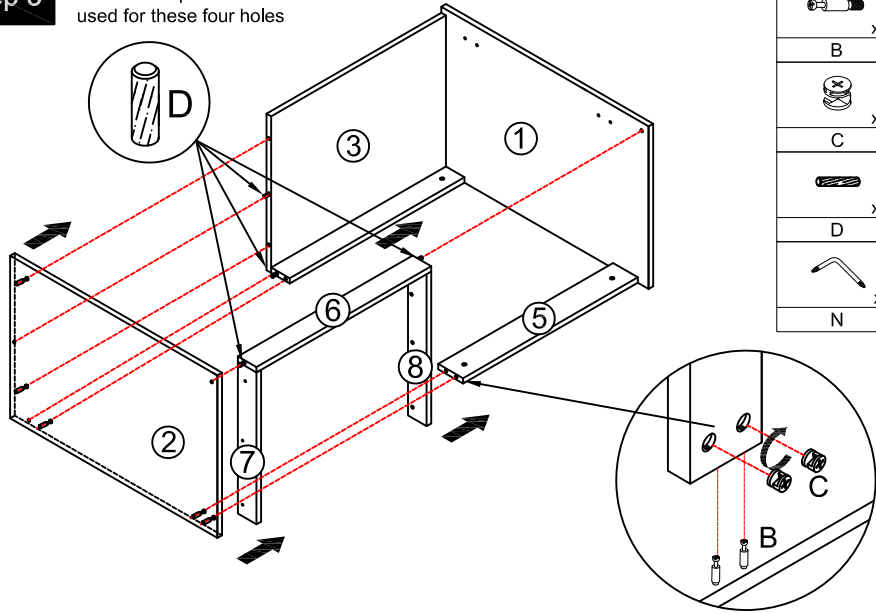

-  x2
- F**
- 
- Tool**



### Step 5







Note: The D parts are used for these four holes

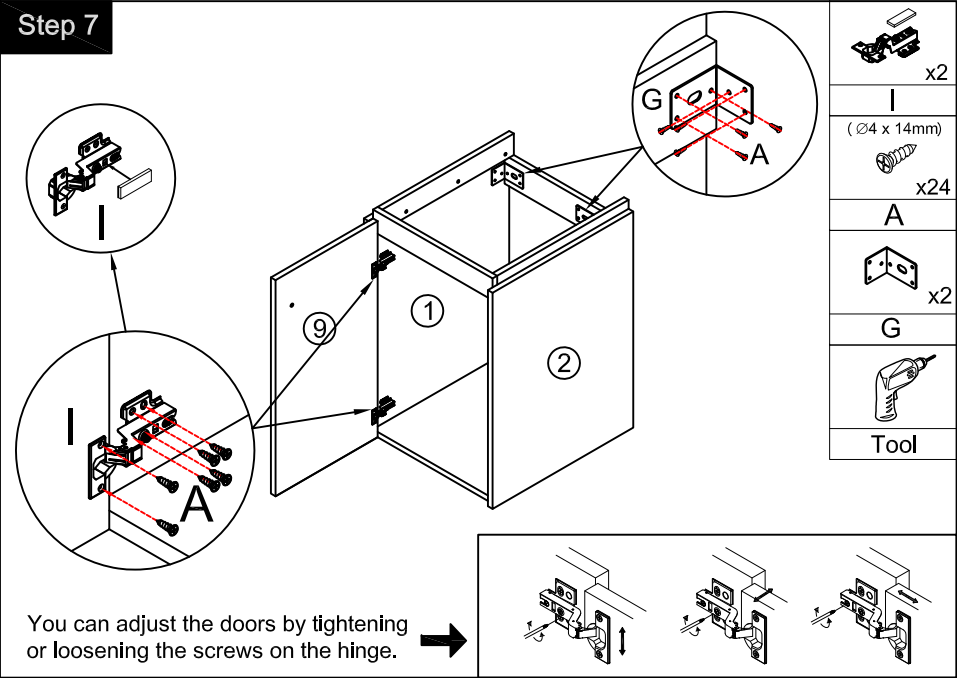

-  x5
-  B
-  x5
-  C
-  x4
-  D
-  x1
-  N





### Step 7

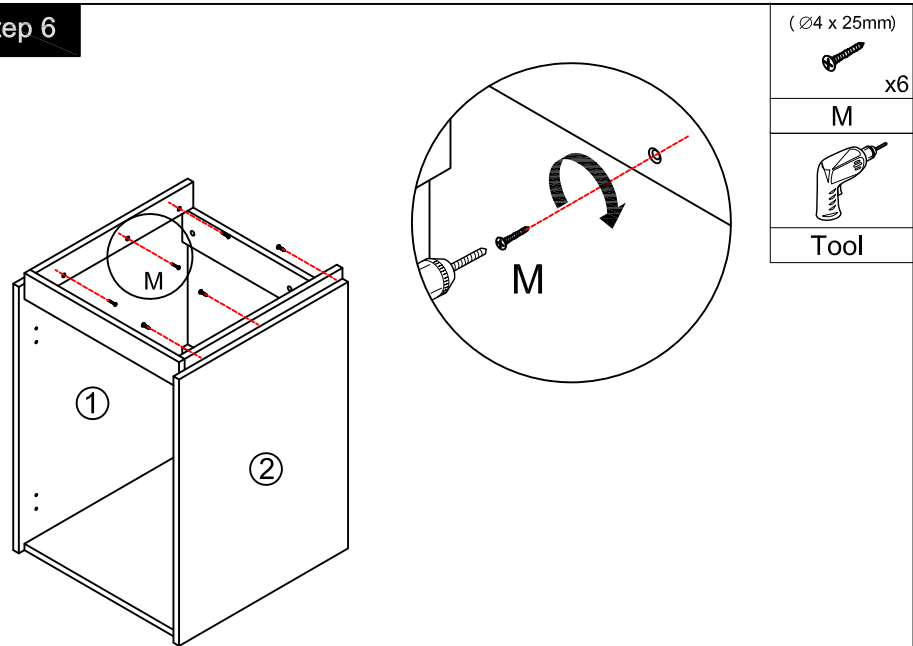

-  x2
-  I (∅4 x 14mm)
-  x24
-  A
-  x2
-  G
-  Tool







### Step 6

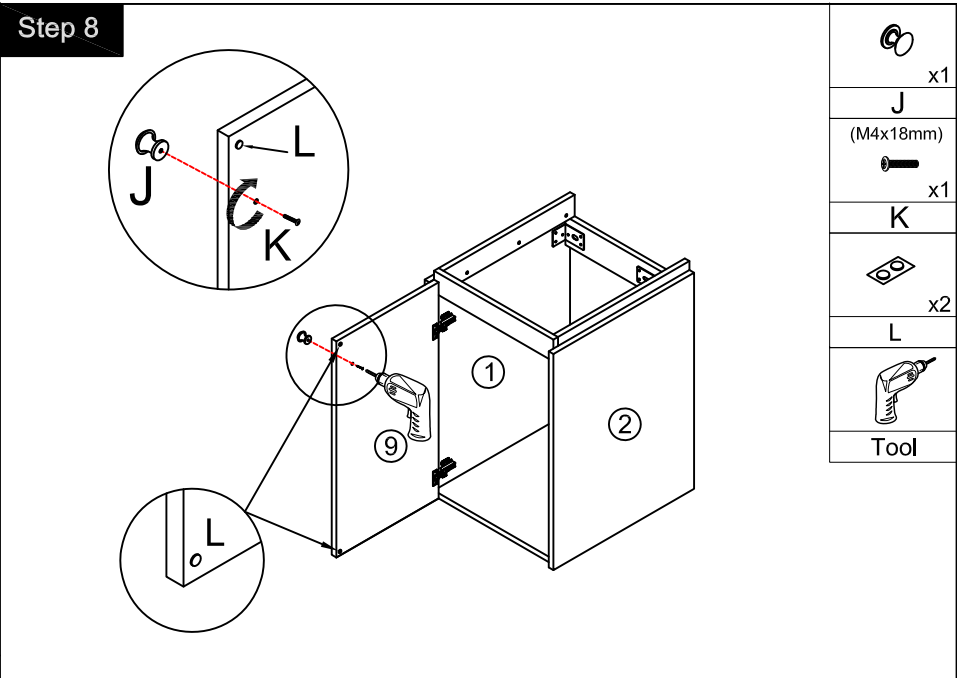

-  (∅4 x 25mm)
-  x6
-  M
-  Tool

### Step 8



-  x1
-  J (M4x18mm)
-  x1
-  K
-  x2
-  L
-  Tool