























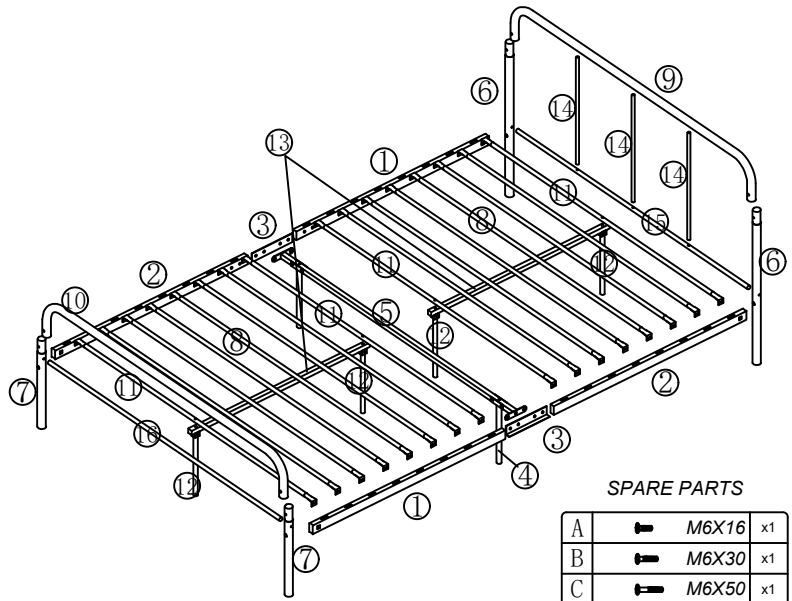



WARNING





·Please don't fasten all screws until you assemble full bed.

A		M6X16	x4
B		M6X30	x7
C		M6X50	x4
D		M8X15	x8
E		M8X35	x2
F		M8X50	x4
G		M8X70	x4
H		M6X18	x8
I			x12
J			x2
K			x4
L			x32
M		M4	x2
N		M5	x1

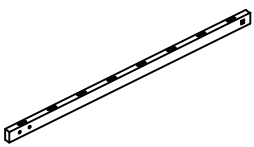
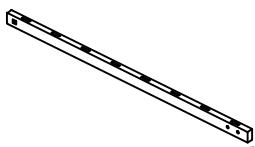
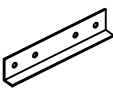
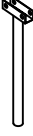
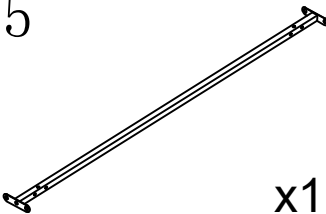
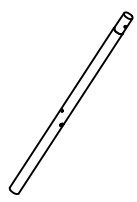

SPARE PARTS

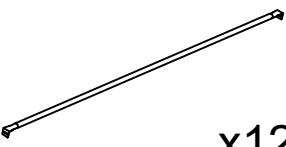
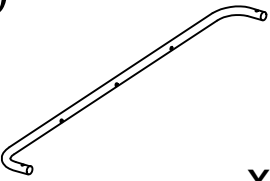
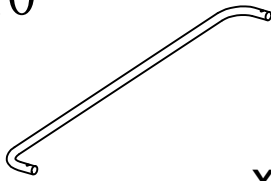
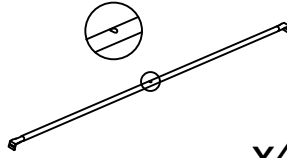
A		M6X16	x1
B		M6X30	x1
C		M6X50	x1
D		M8X15	x1
E		M8X35	x1
F		M8X50	x1
G		M8X70	x1
H		M6X18	x1
I			x1
J			x1
K			x1
L			x1

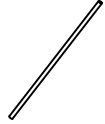
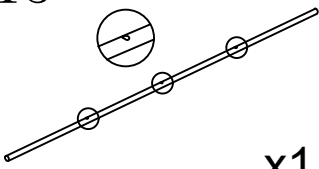
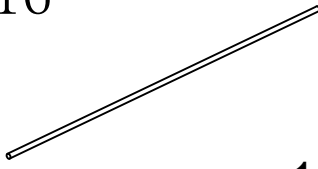
1  x2	2  x2	3  x2	4  x2
5  x1	6  x2	7  x2	8  x12
9  x1	10  x1	11  x4	12  x4
13  x2	14  x3	15  x1	16  x1

STEP 1

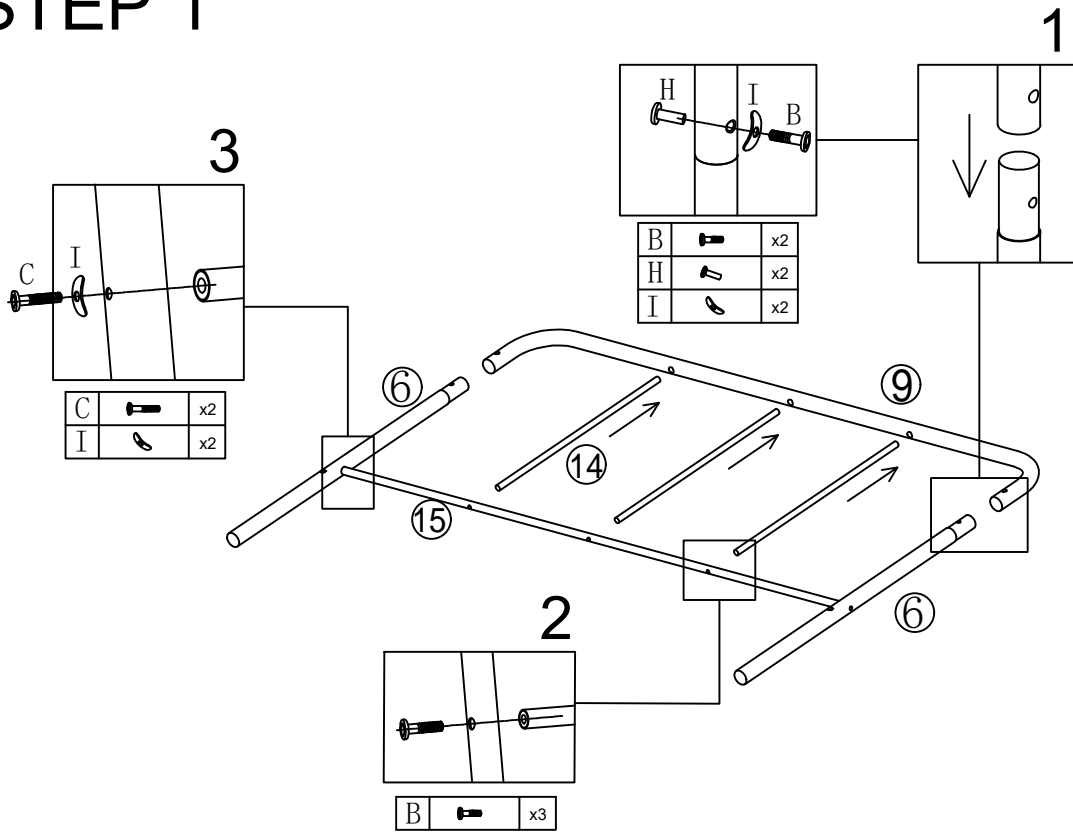

STEP 2

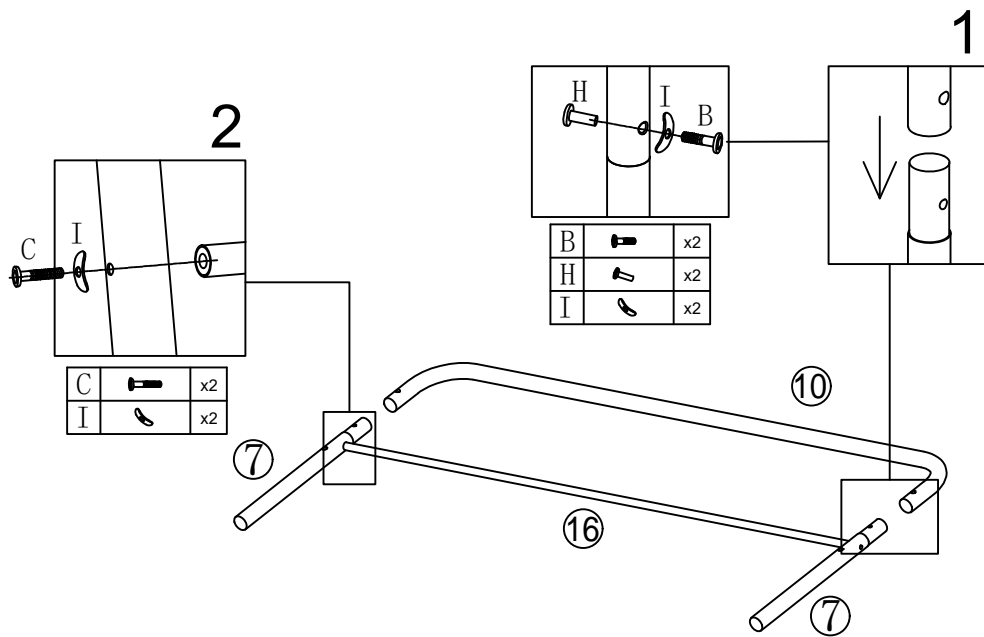

STEP 3

Diagram illustrating Step 3: Assembly of the bed frame rails. The main diagram shows the headboard and footboard rails (labeled 1) being attached to the side rails (labeled 2) using brackets (labeled 3). The assembly is shown from both a top-down perspective and a side view.

Sub-diagram 1 shows the attachment of bracket 3 to rail 1 using screw D. A callout box shows screw D (x2).

Sub-diagram 2 shows the attachment of bracket 3 to rail 2 using screw D. A callout box shows screw D (x2).

Sub-diagram 3 shows the attachment of bracket 3 to the side rail using screw D. A callout box shows screw D (x2).

Callout box: Please tear off the blue film before assemble part ③ like the photos

Parts list for Step 3:

G		x4
I		x4
K		x4

STEP 4

Diagram illustrating Step 4: Assembly of the bed base. The main diagram shows the headboard and footboard rails (labeled 1) being attached to the side rails (labeled 2) using brackets (labeled 5). The assembly is shown from both a top-down perspective and a side view.

Sub-diagram 1 shows the attachment of bracket 5 to rail 1 using screw A, screw E, and bracket H. A callout box shows screw A (x4), screw E (x2), and bracket H (x4).

Sub-diagram 2 shows the attachment of bracket 5 to rail 2 using screw D. A callout box shows screw D (x4).

Sub-diagram 5 shows the attachment of bracket 5 to the side rail using screw J. A callout box shows screw J (x2).

Parts list for Step 4:

A		x4
E		x2
H		x4
J		x2

STEP 5

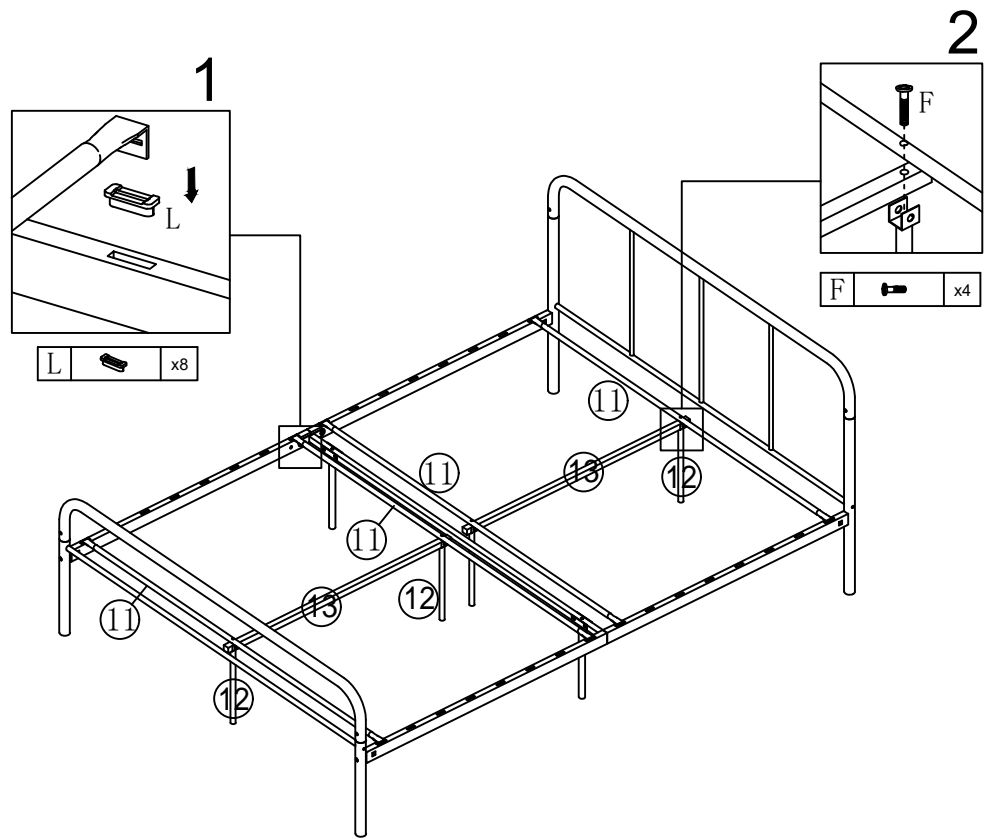

STEP 6

