

TRIO BUNKBED

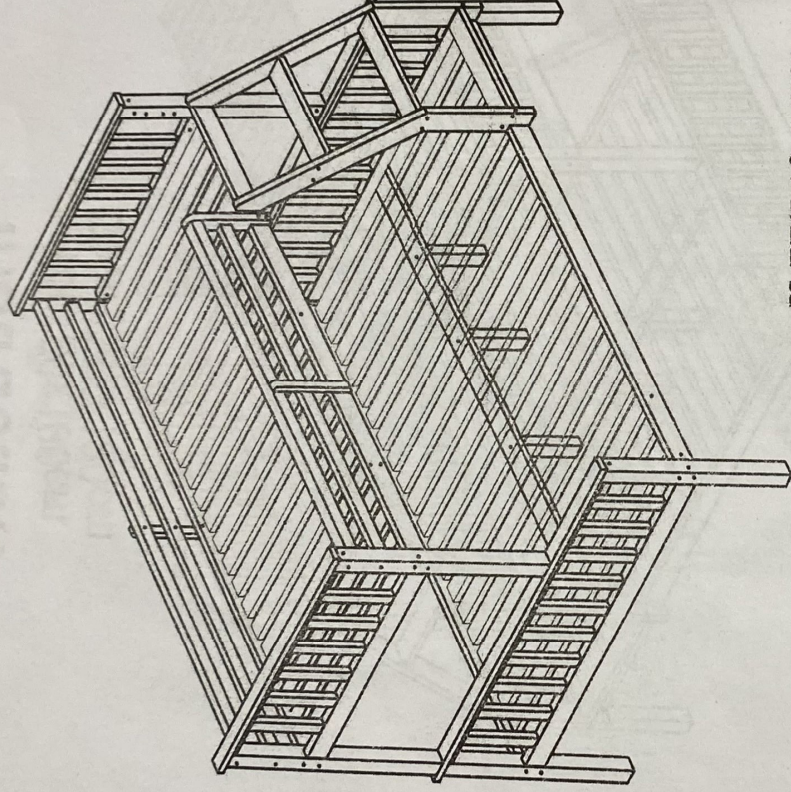

BS EN747-1 & -2:2012+A1:2015

IMPORTANT

PLEASE READ CAREFULLY AND RETAIN FOR FUTURE REFERENCE

Carefully check that you have all the components prior to assembly.

Unpack and assemble this furniture on a clean, flat, protective surface in the room it will be used.

We recommend that the packaging is used to protect the surfaces during assembly.

Make sure all fittings are securely tightened prior to use. It may be necessary to tighten any fittings from time to time depending on use, this is normal with flat pack furniture.

Save all packing material until assembly is complete to avoid accidentally discarding smaller parts or hardware.

WARNING Do not use the bunk bed/high bed if any structural part is broken or missing.

WARNING High beds and the upper bed of bunk beds are not suitable for children under six years due to the risk of injury from falls.

WARNING Bunk beds and high beds can present a serious risk of injury from strangulation if not used correctly. Never attach or hang items to any part of the bunk bed that are not designed to be used with the bed, for example, but not limited to ropes, strings, cords, hooks, belts and bags.

WARNING Children can become trapped between the bed and the wall, a roof pitch, the ceiling, adjoining pieces of furniture (e.g. cupboards) and the like. To avoid risk of serious injury the distance between the top safety barrier and the adjoining structure shall not exceed 75 mm or shall be more than 230 mm









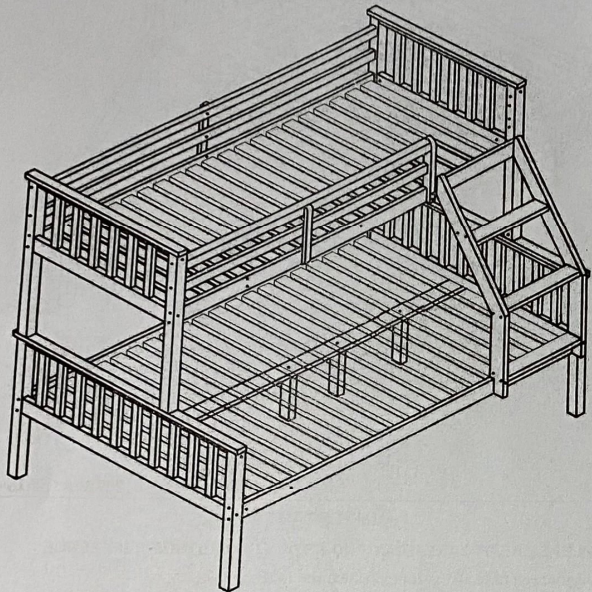



Always follow the manufacturer's instructions;

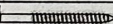

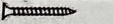

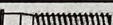









Please keep the original packaging until the item is fully assembled and in place. In the unlikely event that you need to return your product, it must be returned in its original packaging to avoid further damage.

Instruction

Top: 90x190cm
Down: 135x190cm



A	 	30
B		32
C		36
D	 	08
E	 	66
F	 	17
G	 	16
H	 	06

I	 	02
J		04
K	 	13
L	 	04
M	 	02
N		02
O	 	08
P		01
Q	 	40

PARTS LIST

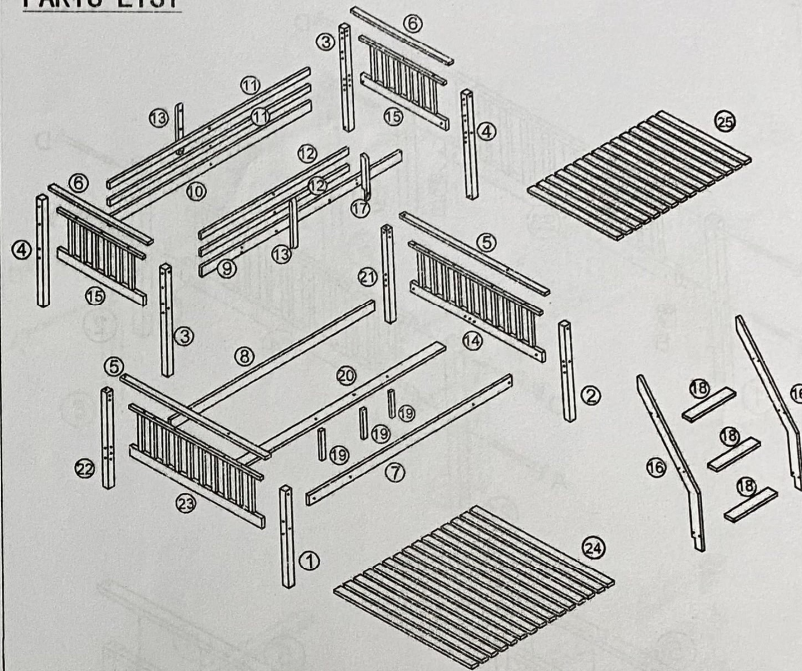



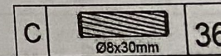
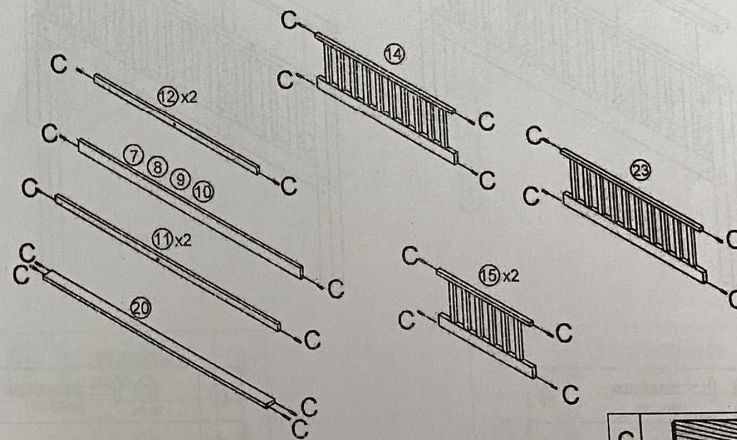

1



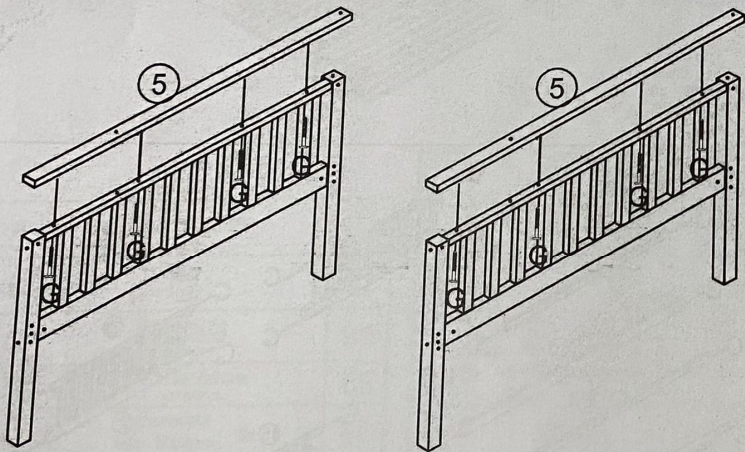
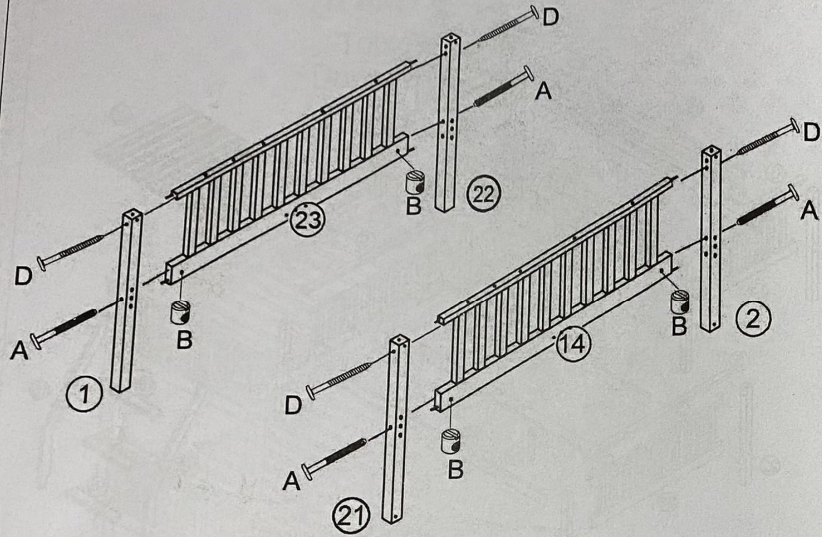

36

2



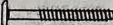



A	 15mm	 Ø6x90mm	4
B			4

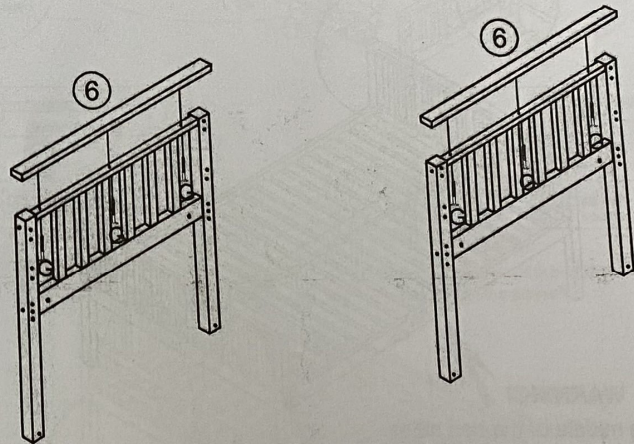
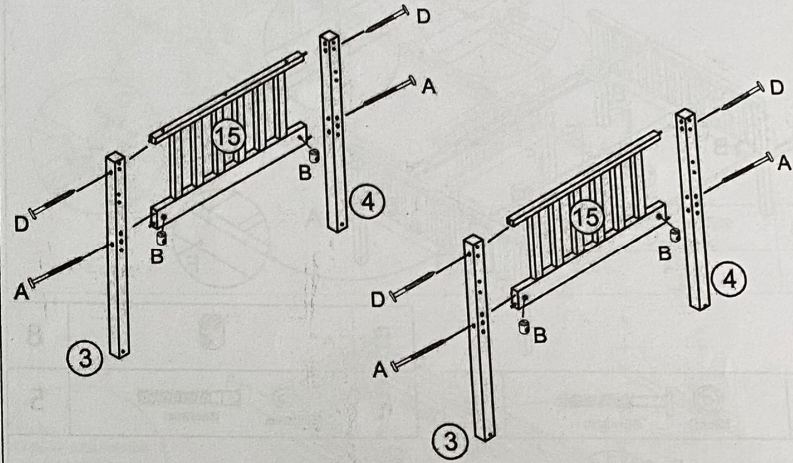

D	 15mm	 Ø6x90mm	4
G	 15mm	 Ø6x70mm	8

P.3

3

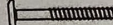

A	 15mm	 Ø6x90mm	4
B			4

D	 15mm	 Ø6x90mm	4
G	 15mm	 Ø6x70mm	6

P.4

4

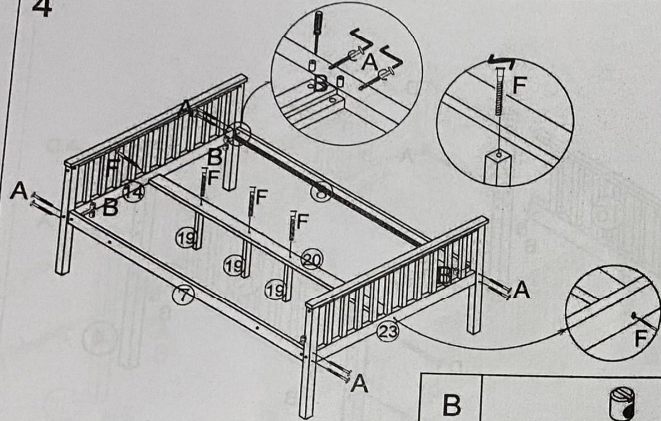

A		8
B		8
F		5

5



WARNING!
Press the middle of the bed sides
and tighten the screw!!!

E		30
---	--	----

6

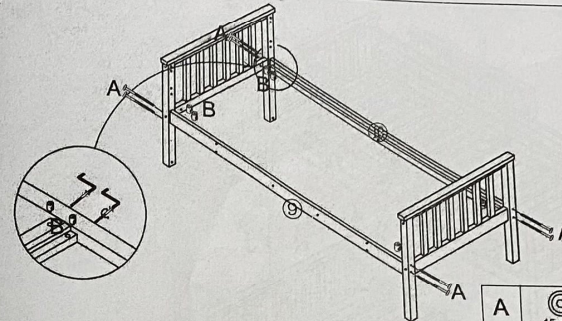

A		8
B		8

7

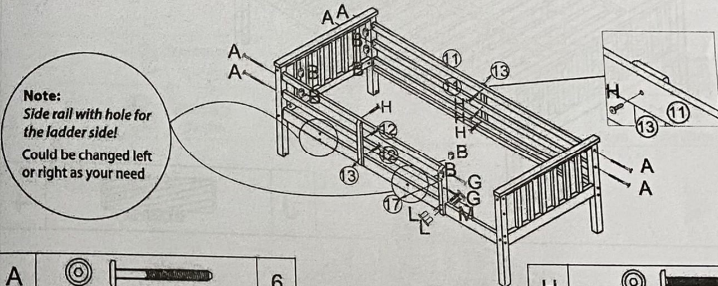

Note:
Side rail with hole for
the ladder side!
Could be changed left
or right as your need

A		6
B		8
G		2
H		6
L		2
M		2

8

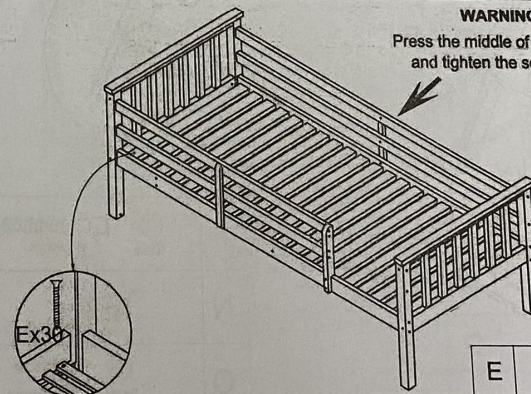

WARNING!
Press the middle of the bed sides
and tighten the screw!!!

E		30
---	--	----

9

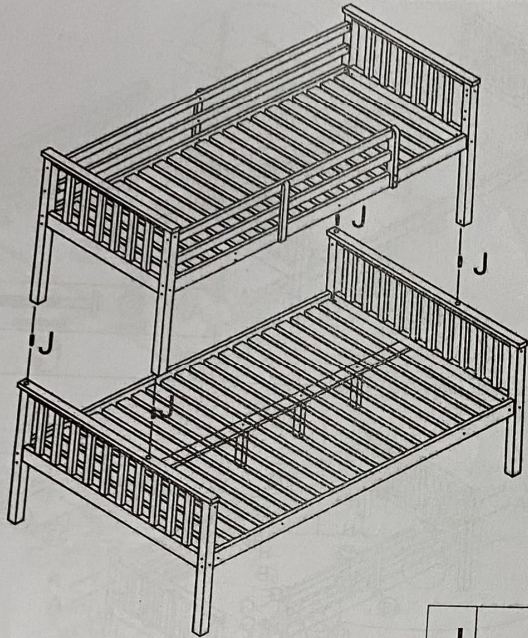



J		4
---	---	---

Ø12x80mm

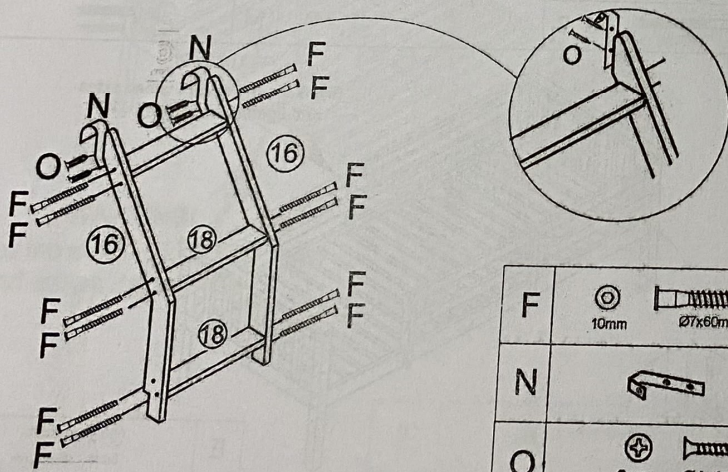
10

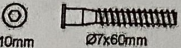

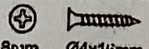
F		12
N		02
O		04

10mm Ø7x60mm
8mm Ø4x16mm

11

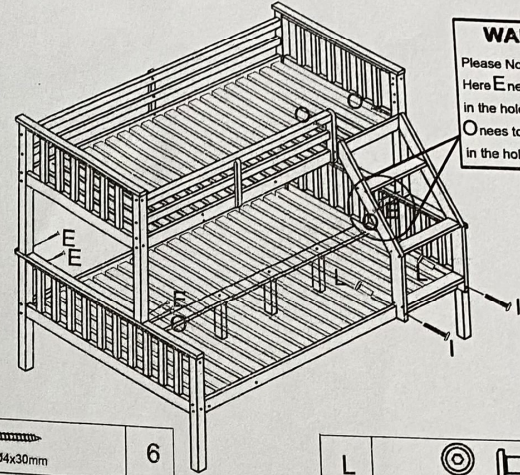

WARNING!
Please Note :
Here E needs to be screwed
in the hole on the leg hole,
O needs to be screwed
in the hole below.

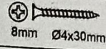
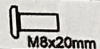
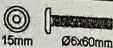
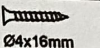
E		6	L		2
I		2	O		4

8mm Ø4x30mm
15mm Ø6x60mm
15mm M8x20mm
8mm Ø4x16mm

12

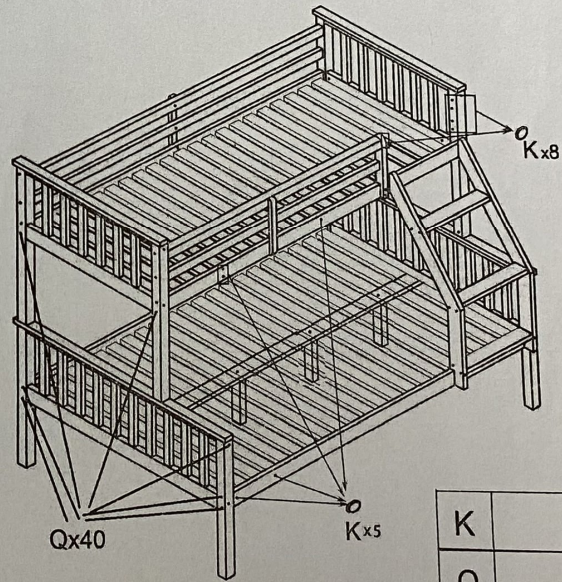

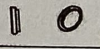
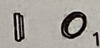
K		13
Q		40

8mm
15mm