

# 6 DRAWER CABINET

Assembly Instructions - Please keep for future reference

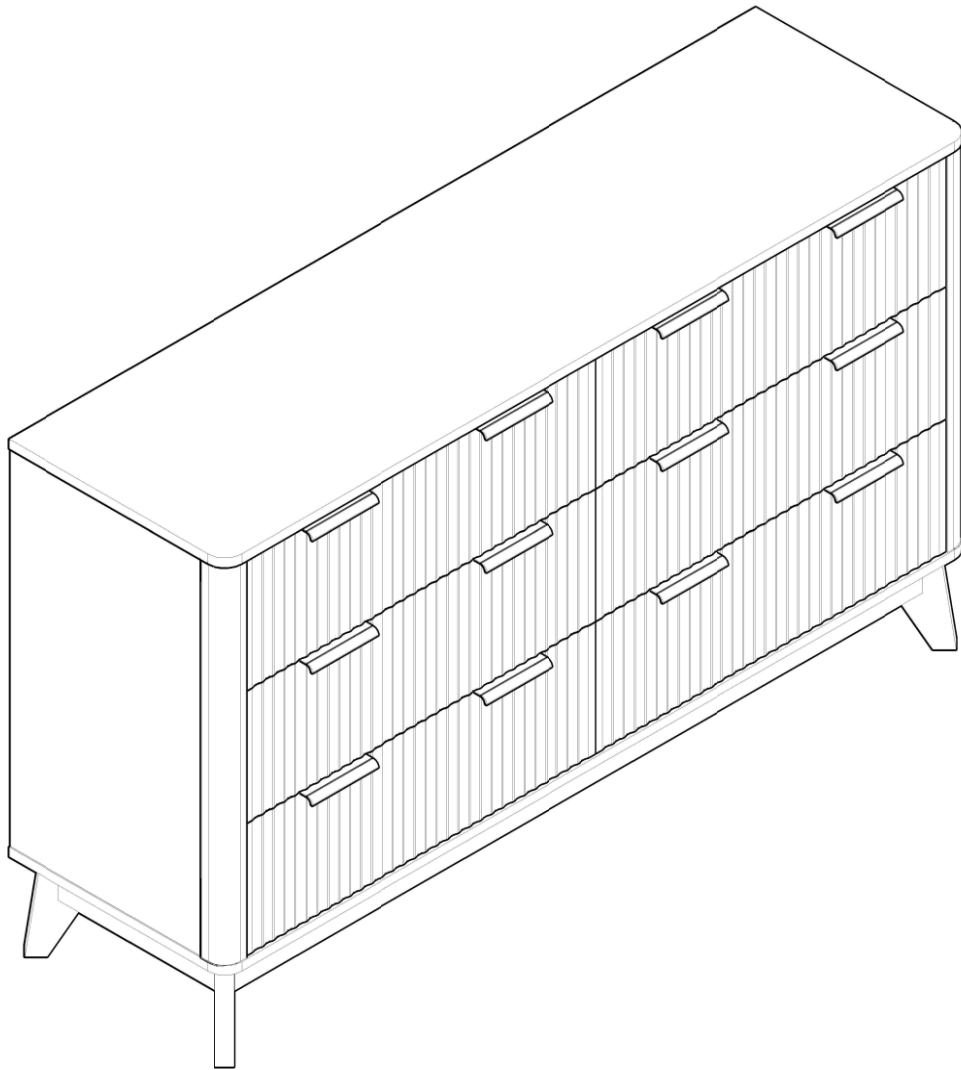

## Dimensions

Width-53.9 inch  
Depth-15.6 inch  
Height-32 inch

Important – Please read these instructions fully before starting assembly



# Safety and Care Advice

## Important – Please read these instructions fully before starting assembly

- Check you have all the components and tools listed on the following pages.
- Remove all fittings from the plastic bags and separate them into their groups.
- Keep children and animals away from the work area, small parts could choke if swallowed.
- Make sure you have enough space to layout the parts before starting.

- During assembly do not stand or put weight on the product, this could cause damage.
- Assemble the item as close to its final position (in the same room) as possible.
- Assemble on a soft level surface to avoid damaging the unit or your floor.
- Parts of the assembly will be easier with 2 people.



- To reduce the likelihood of damaging your product please ensure that your power drill is set on a low torque setting.

## Care and maintenance

• Only clean using a damp cloth and mild detergent, do not use bleach or abrasive cleaners.

• From time to time check that there are no loose screws on this unit.

• This product should not be discarded with household waste. Take to your local authority waste disposal centre.

## Handy Hints

• Assemble all parts and bolts loosely during assembly, only once the product is complete should you fully tighten the bolts.

• Regularly check and ensure that all bolts and fittings are tightened properly.

## WARNING

**In order to help prevent overturning – please follow these instructions**

To help prevent product toppling over please follow the below steps:-

Use the anti tip strap or wall fixing method provided (if applicable)

Do not allow children to climb or hang on the furniture

Do not open more than one drawer at a time

Do not place heavy items in the top drawers



Do not place heavy items on top of the furniture, unless the furniture has been designed for this purpose

please note that only the anti tip strap is provided.

You will need to provide wall plugs and screws applicable for your wall type

# Components - Panels

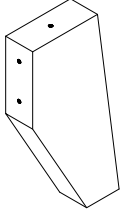

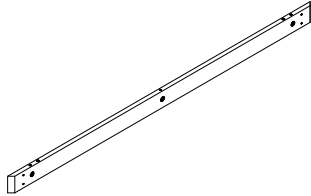
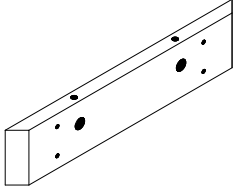
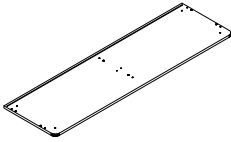
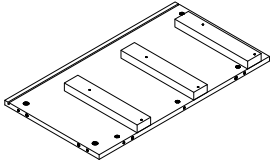
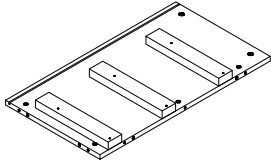
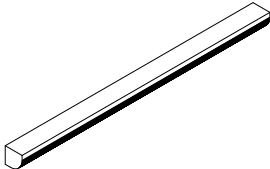
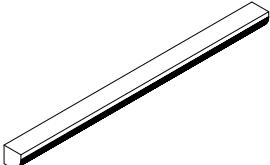
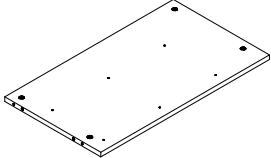
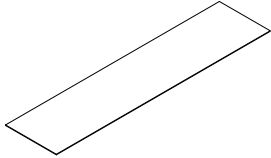
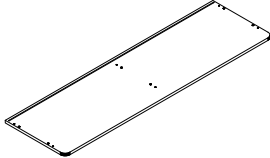
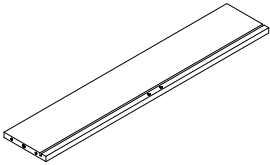
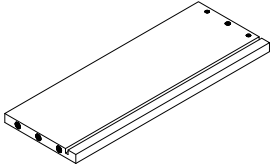
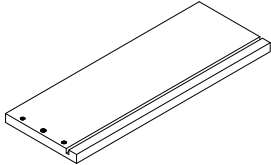
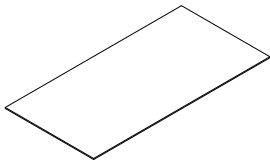
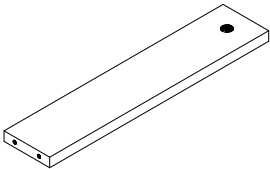
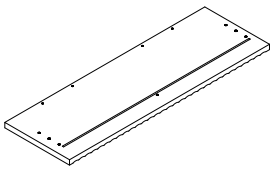
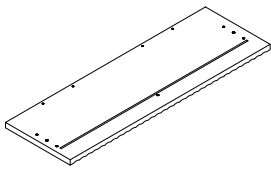



Please check you have all the panels listed below

<p>1</p>  <p>(150*80*25mm)*4</p>	<p>2</p>  <p>(150*50*50mm)*1</p>	<p>3</p>  <p>(1262*60*15mm)*2</p>	<p>4</p>  <p>(287*60*15mm)*2</p>
<p>5</p>  <p>(1370*395*15mm)*1</p>	<p>6</p>  <p>(632*350*40mm)*1</p>	<p>7</p>  <p>(632*350*40mm)*1</p>	<p>8</p>  <p>(632*43*41mm)*1</p>
<p>9</p>  <p>(632*43*41mm)*1</p>	<p>10</p>  <p>(632*360*15mm)*1</p>	<p>11</p>  <p>(1347*320*3mm)*2</p>	<p>12</p>  <p>(1370*395*15mm)*1</p>
<p>13</p>  <p>(585.5*110*12mm)*6</p>	<p>14</p>  <p>(300*110*12mm)*6</p>	<p>15</p>  <p>(300*110*12mm)*6</p>	<p>16</p>  <p>(596*299*3mm)*6</p>
<p>17</p>  <p>(288*60*12mm)*6</p>	<p>18</p>  <p>(640*207*15mm)*3</p>	<p>19</p>  <p>(640*207*15mm)*3</p>	

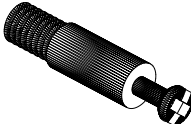
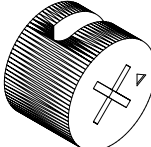
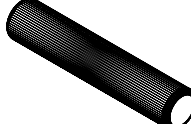
# Components – Fittings

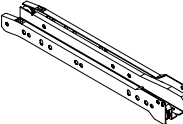
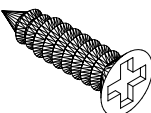
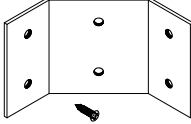
Please check you have all the panels listed below

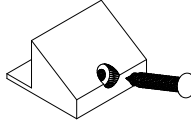
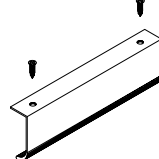
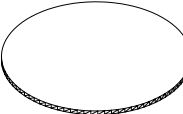
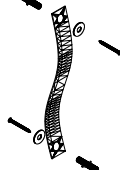
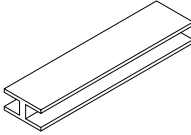
Note: The quantities below are the correct amount to complete the assembly. In some cases more fittings may be supplied than are required.

<p><b>A</b></p>  <p>Cam Bolt*58</p>	<p><b>B</b></p>  <p>Cam Lock*58</p>	<p><b>C</b></p>  <p>8*30mm Wooden Dowel*20</p>
<p><b>D</b></p>  <p>4*35mm Screw*42</p>	<p><b>E</b></p>  <p>Drawer slide*6</p>	<p><b>F</b></p>  <p>3.5*13 Screw*60</p>
<p><b>G</b></p>  <p>Corner brace*4</p>	<p><b>H</b></p>  <p>4*30mm Screw*8</p>	<p><b>I</b></p>  <p>Back panel stiffener*8</p>
<p><b>J</b></p>  <p>Handle*12</p>	<p><b>K</b></p>  <p>Sticker*24</p>	<p><b>L</b></p>  <p>Anti-toppling strip*2</p>
<p><b>M</b></p>  <p>Back panel splice strip**1</p>	<p><b>N</b></p>  <p>6*30mm Wooden Dowel*24</p>	

## Tools required

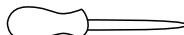
 Phillips screwdriver  
(medium & large)

Ruler - Use this ruler to help correctly identify the screws

0 5 10 15 20 25 30 35 40 45 50 55 60 65 70 75 80 85 90 95 100 105 110 115 120 125 130 135 140 145 150 155 160 165 170

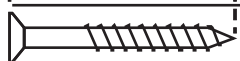

The screws length is measured from the head to the point (30mm screw shown).

# Using Camlocks

## Step 1

Connect the male camlock as directed in the assembly instructions using a screwdriver.

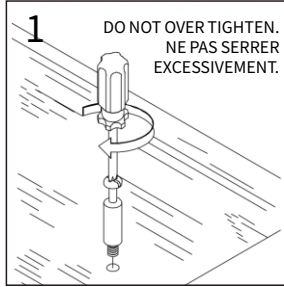

## Step 2

Push the male camlock into the entry hole.

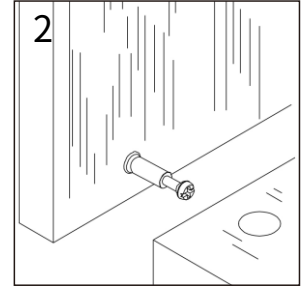

## Step 3

Insert the female camlock as shown in the instruction.  
Note: ensure that the arrow on the top of the camlock points towards the entry hole for the male camlock.

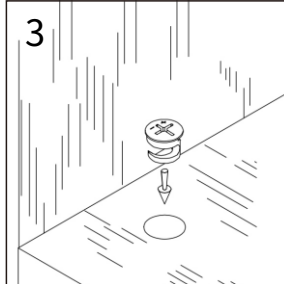

## Step 4

Turn the female camlock clockwise with a screwdriver. You should feel a click when the camlock is locked in place. The joint is now secure.

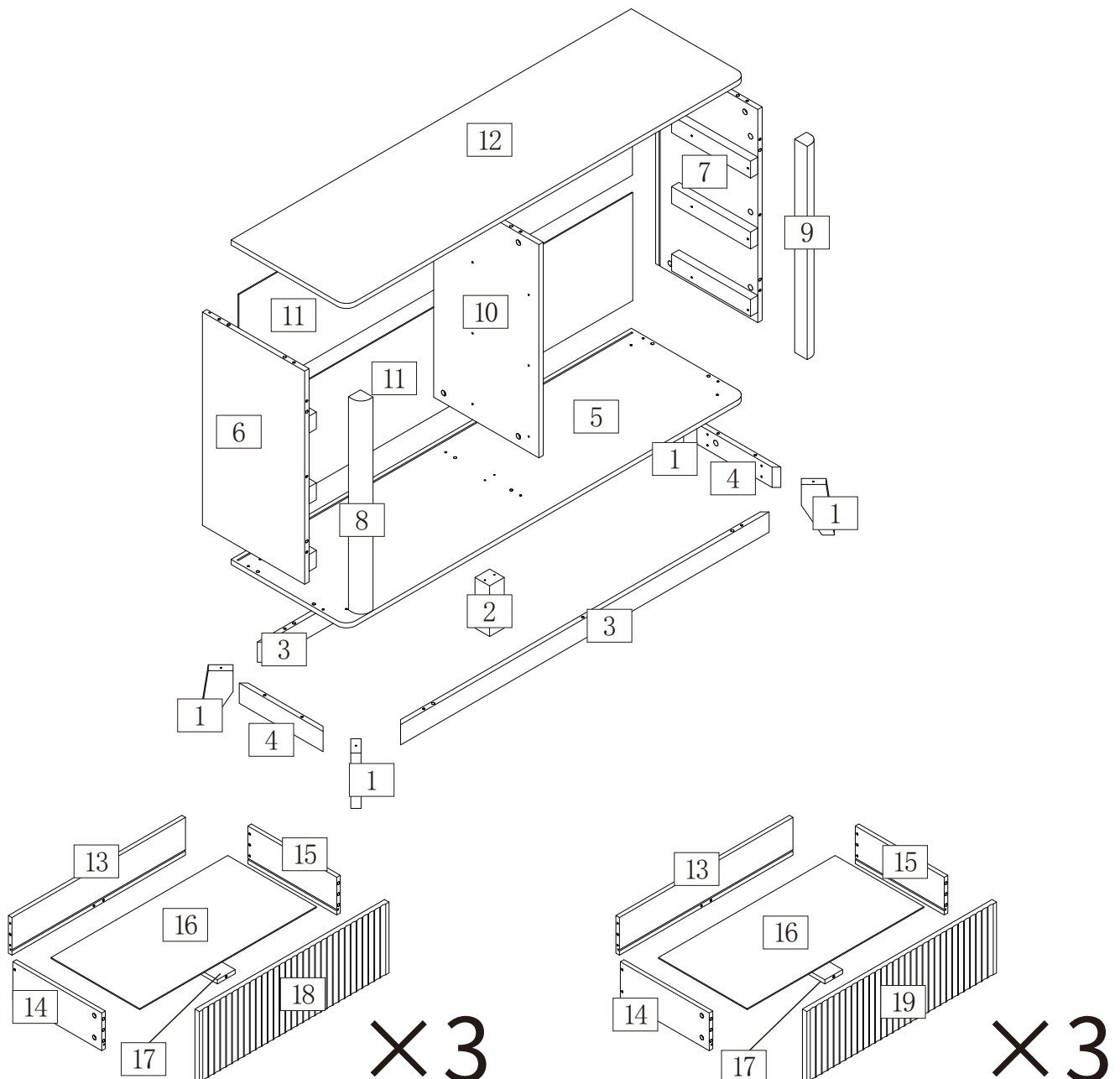
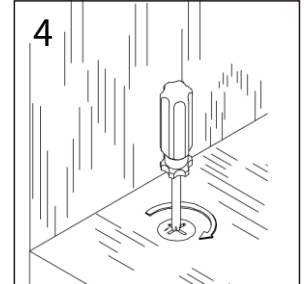

# Assembly instructions

## Step 1

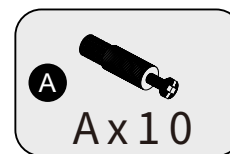
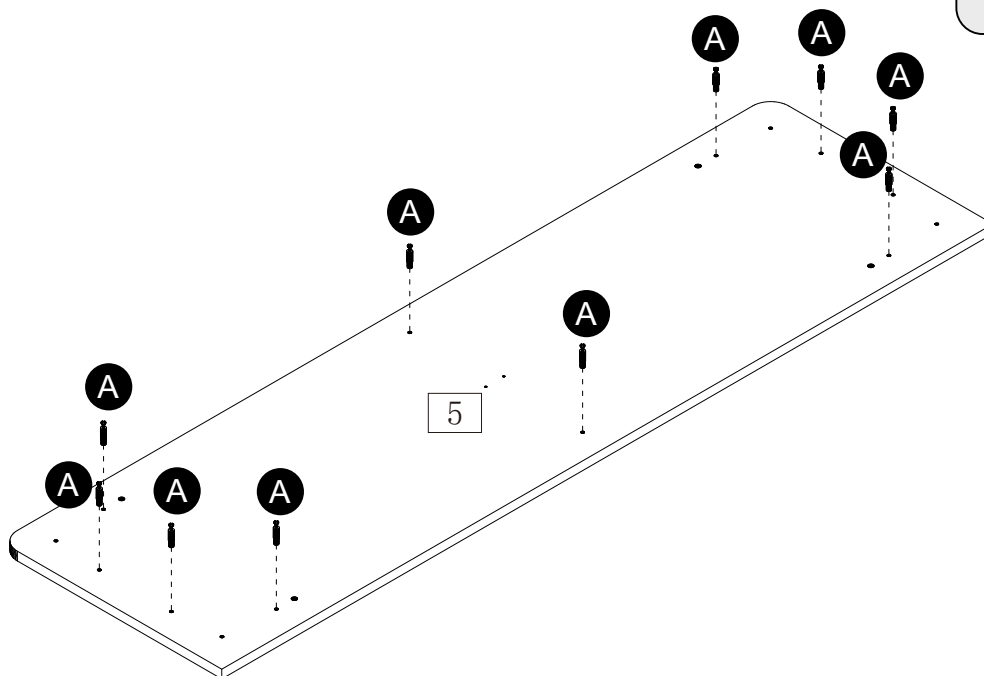

Install Cam bolt(A) on part (5)

## Step 2

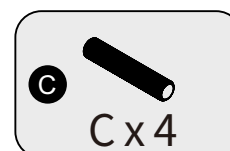
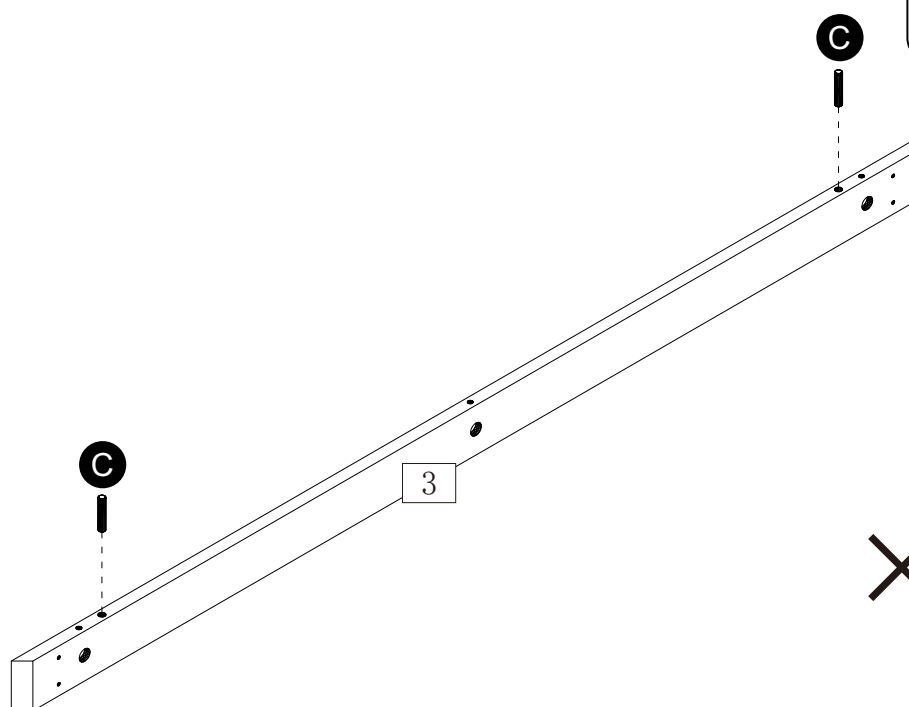

×2

Install wooden Dowel (C) on part (3)

# Assembly instructions

## Step 3

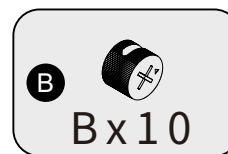
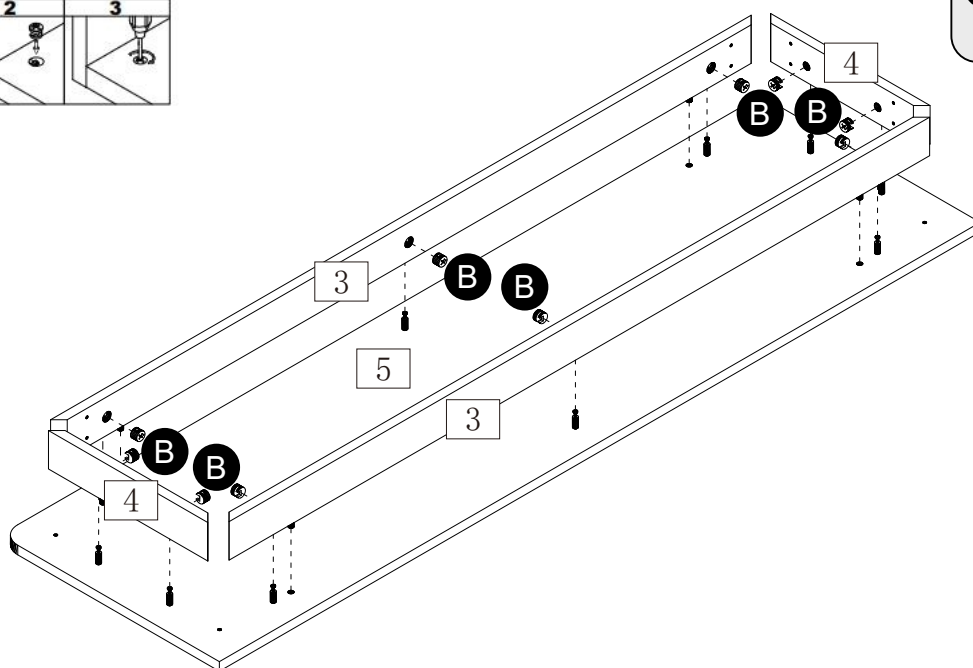
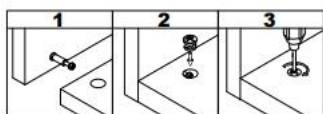

Attach long panel (3) and short panel (4) to panel (5), then use Cam Lock (B) to lock it.

## Step 4

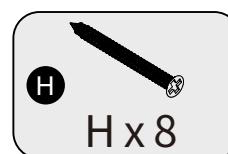
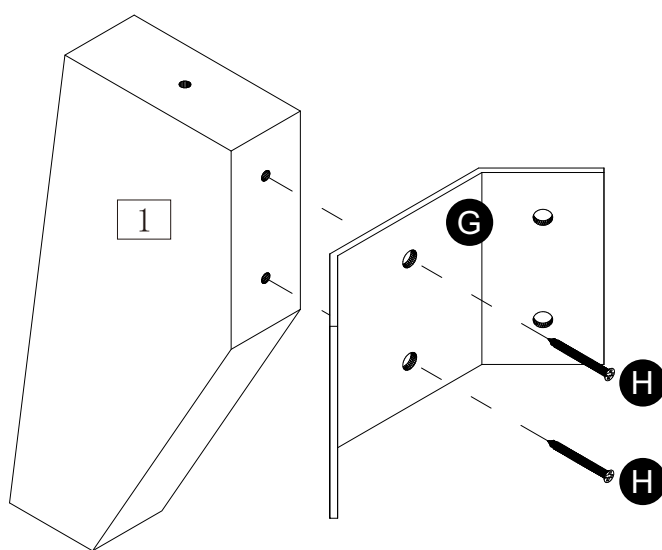

× 4

Use screw (H) to secure part(G) to panel (1)

# Assembly instructions

## Step 5

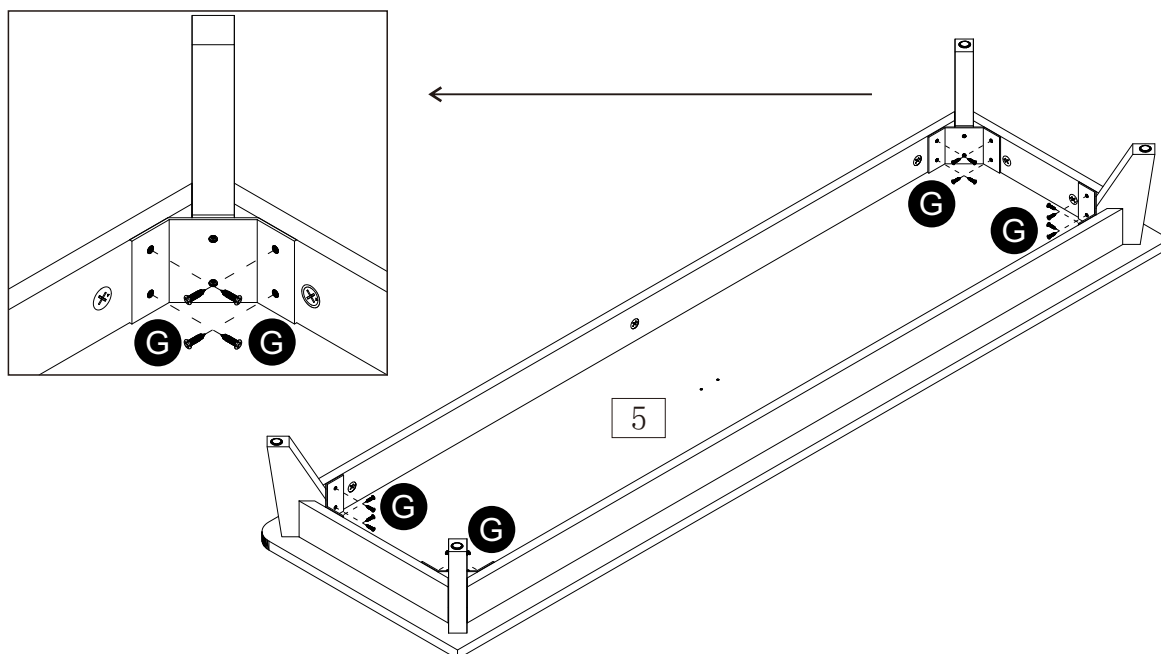

Use the Screw comes with the corner brace (G) to attach the assembled leg and lock it

## Step 6

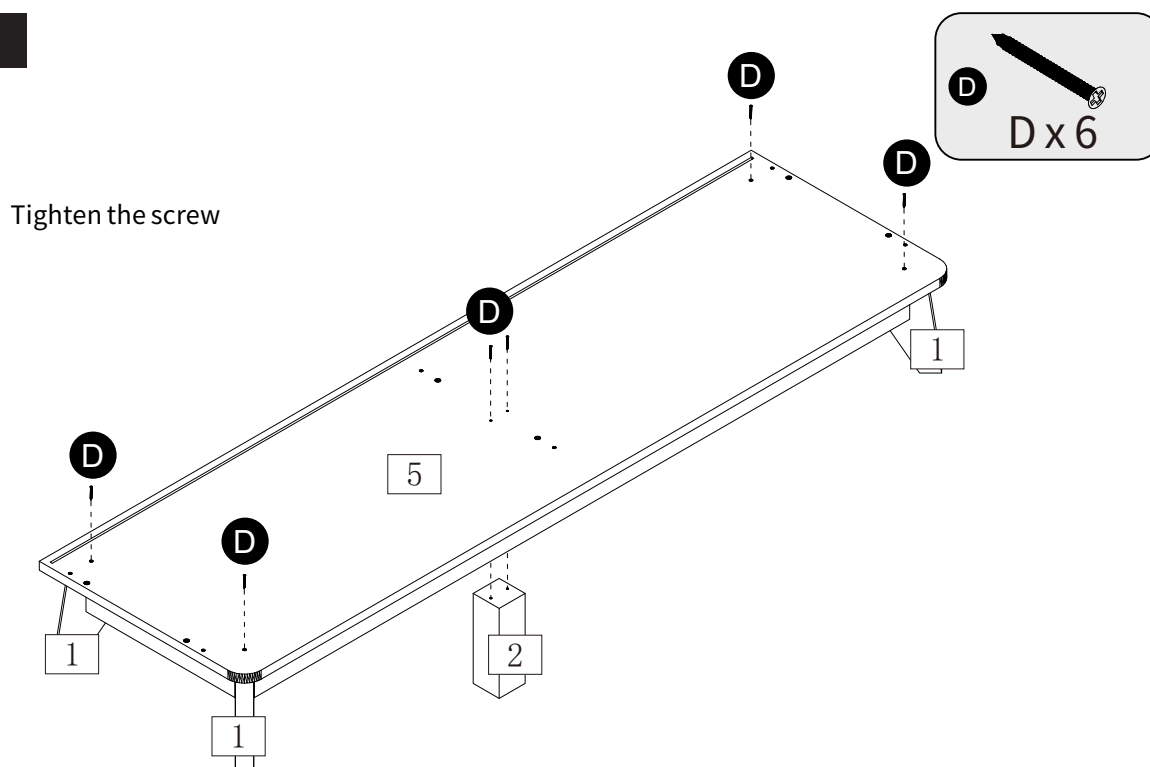

Turn Over the assembled base, use Srew (D) to attach part (5) and part (1) with part (2) , then lock it.

# Assembly instructions

## Step 7

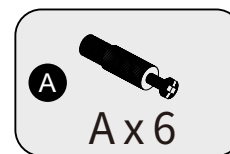
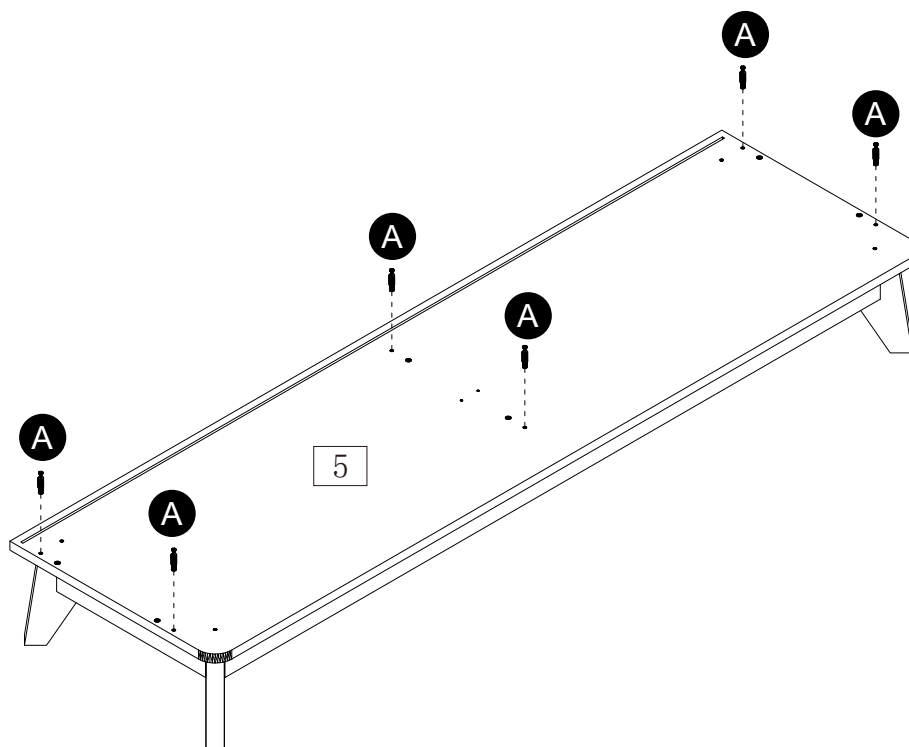

Attach Cam Bolt (A) to part (5)

## Step 8

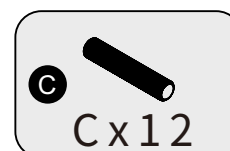
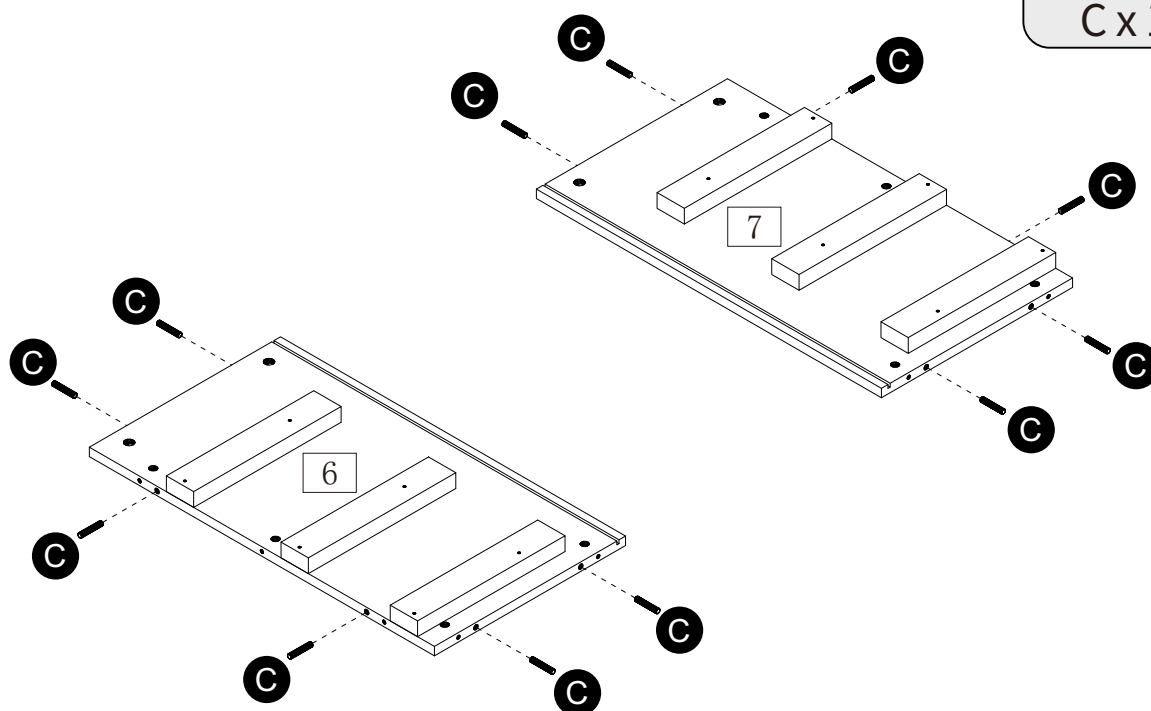

Attach Wooden Dowel (C) to the right & left panel (6.7)

# Assembly instructions

## Step 9

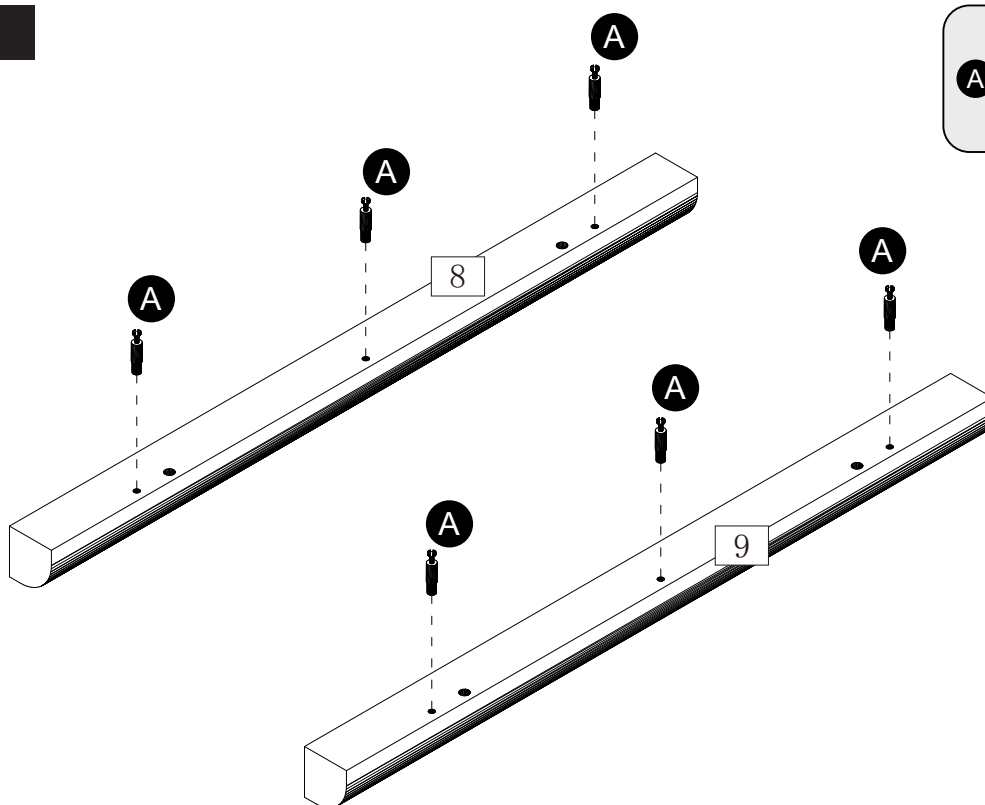

Attach Cam Bolt (A) to the part (8.9)

## Step 10

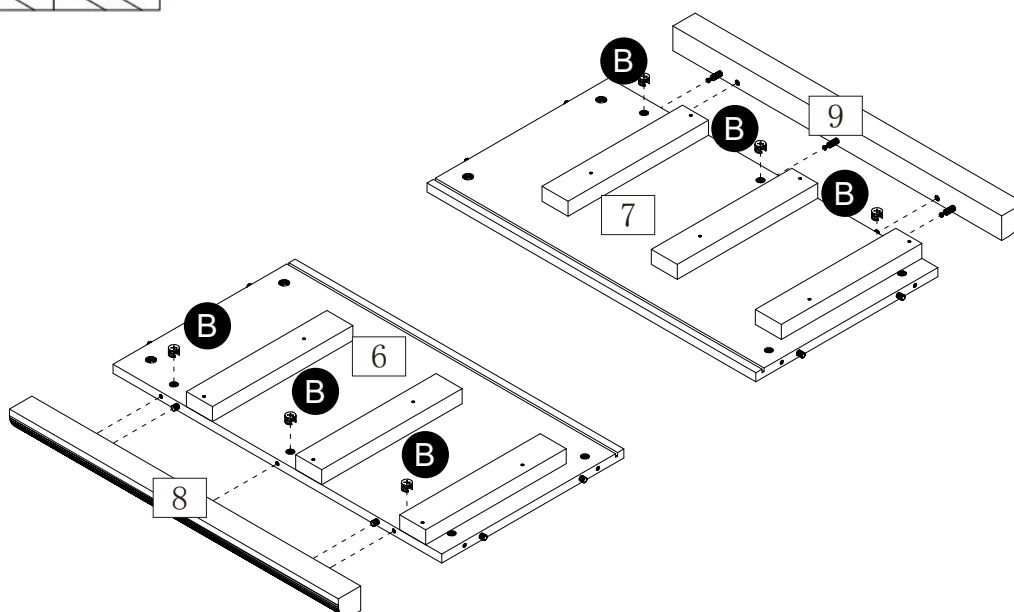
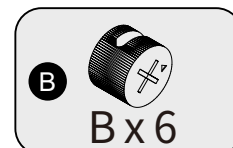
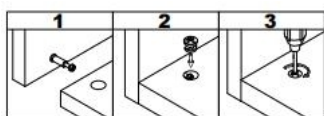

Use Cam Lock (B) to attach the panel(8.9) with panel(6.7) and lock it.

# Assembly instructions

## Step 11

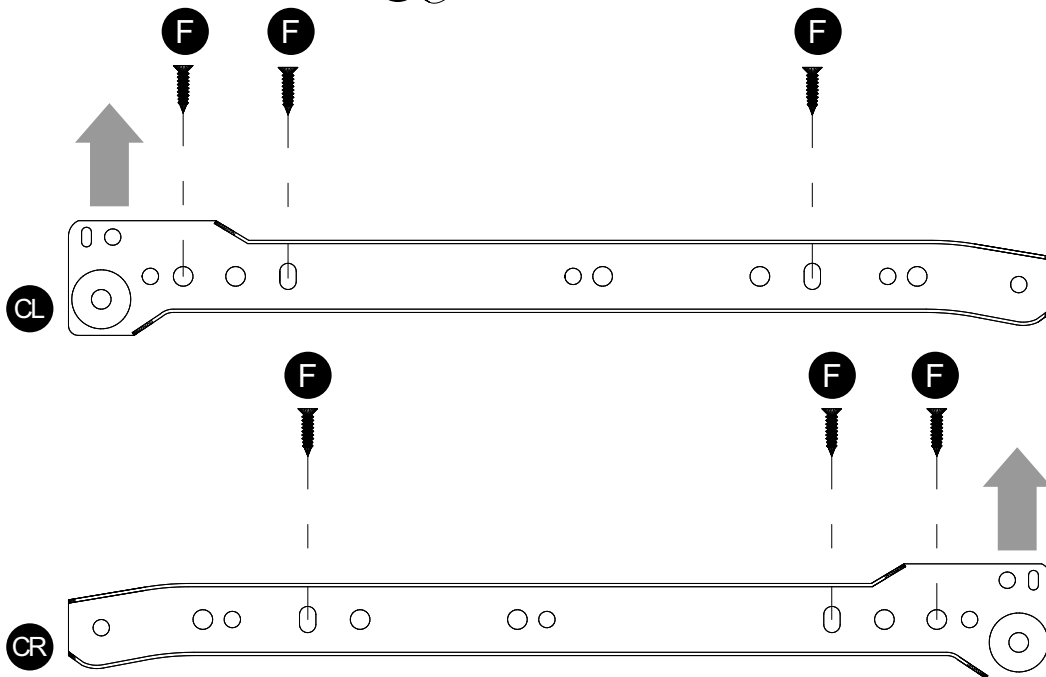
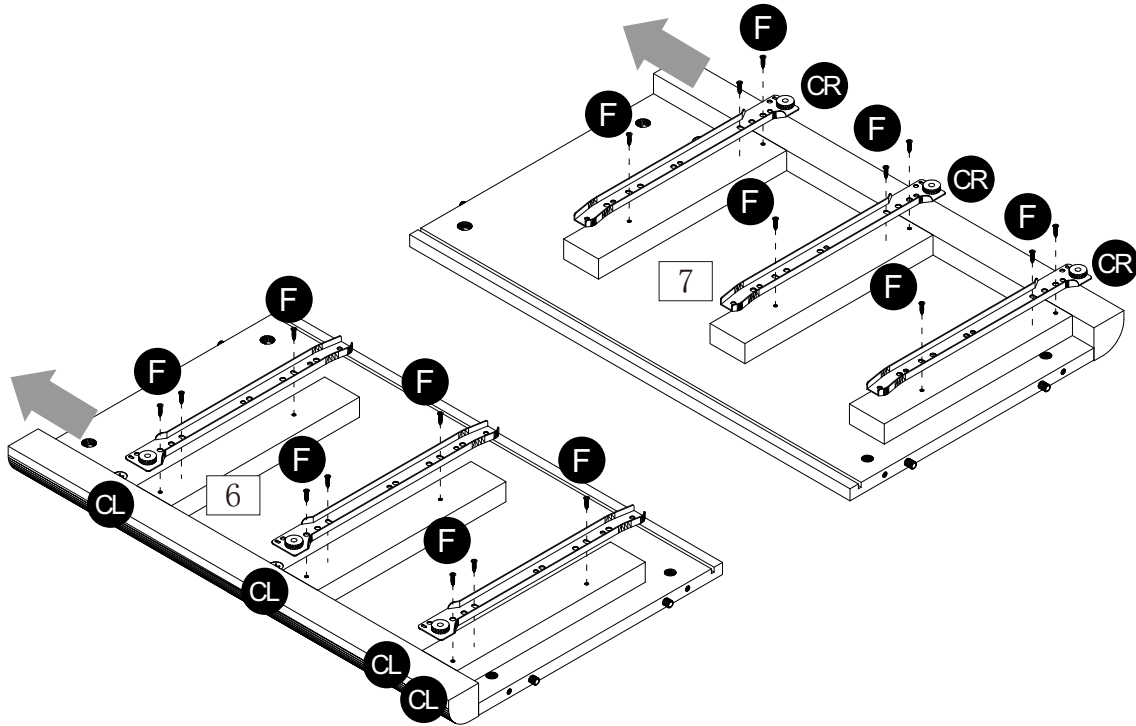
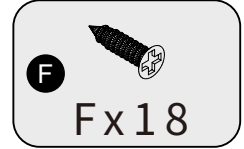
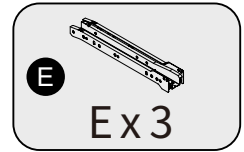
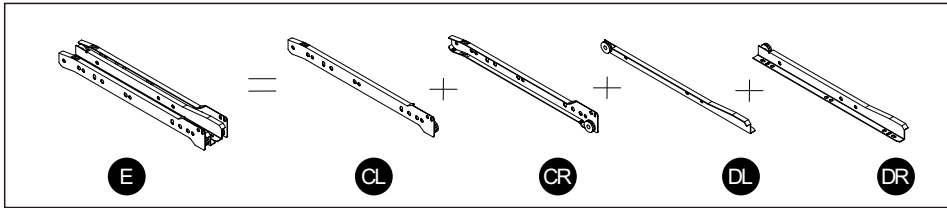

Use the screw (F) to attach the left part of rail (CL) to the left panel (6)  
Use the screw (F) to attach the right part of rail (CR) to the right panel (7)

# Assembly instructions

## Step 12

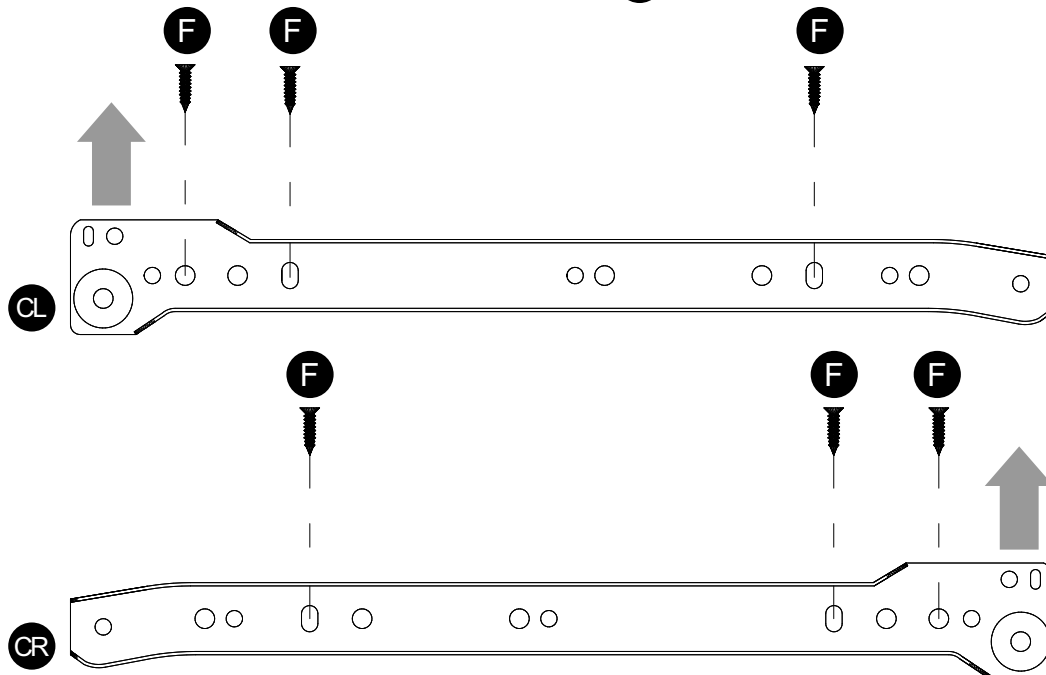
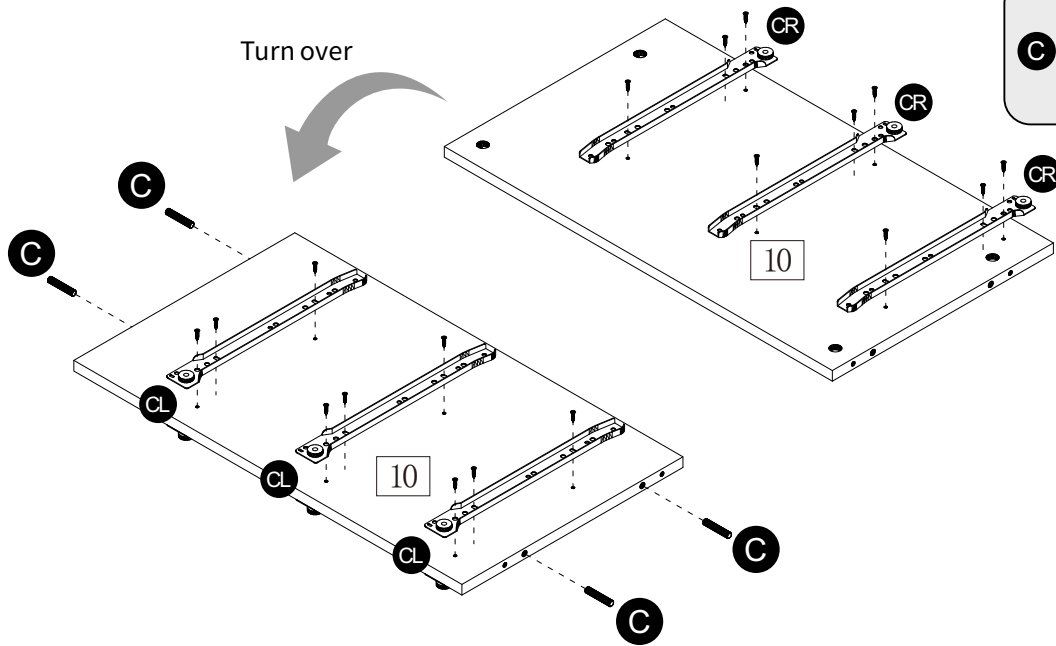
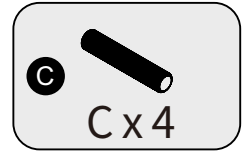
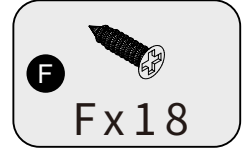
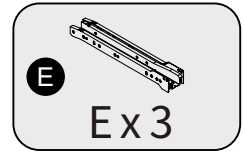
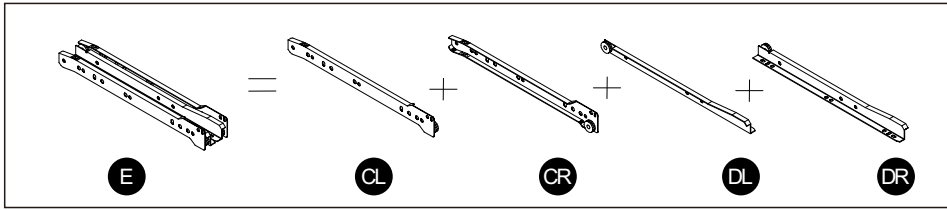

Use the screw (F) to install the left & Right part of rail (CR & CL) on panel (10)  
Then install wooden Dowel (C) on part (10)

# Assembly instructions

## Step 13

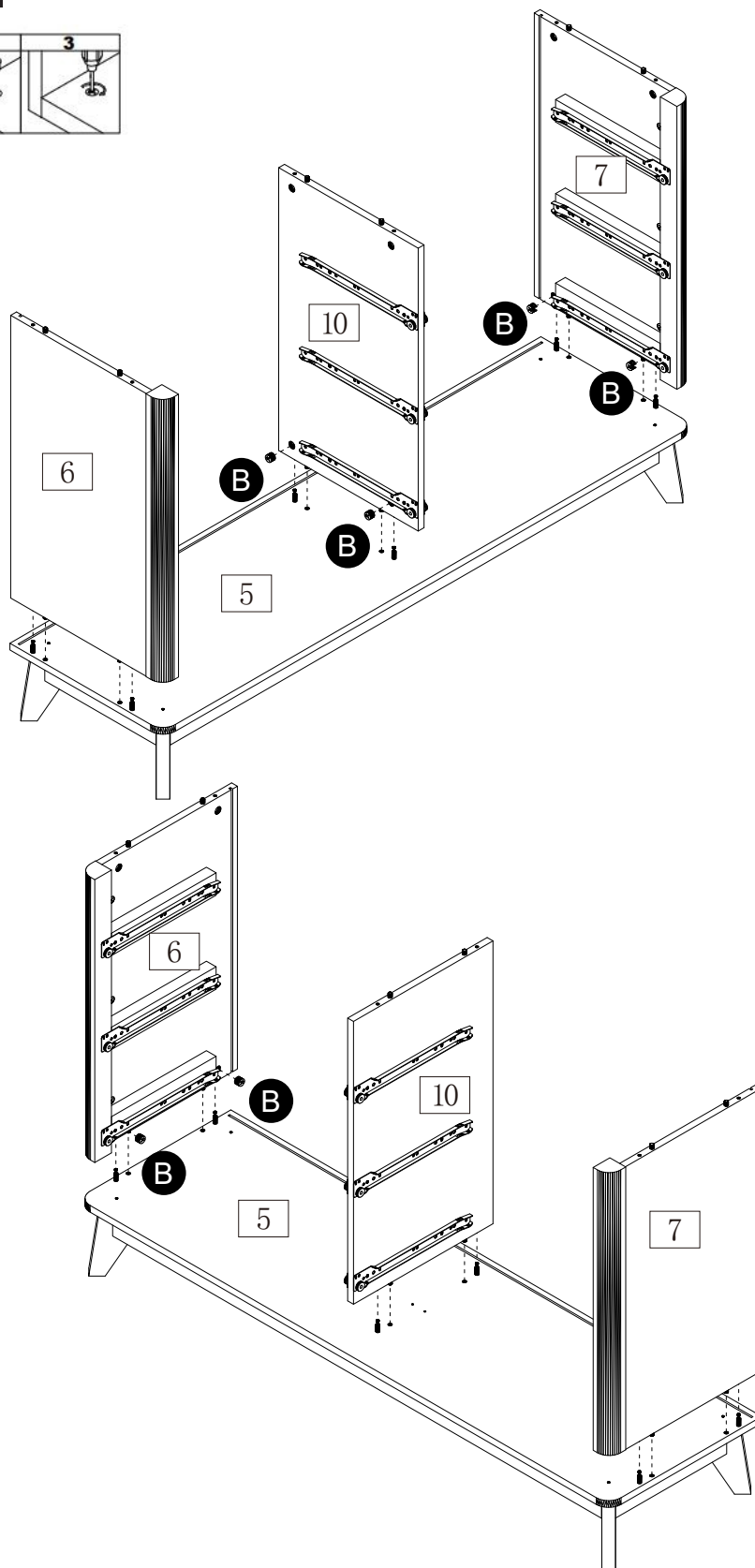
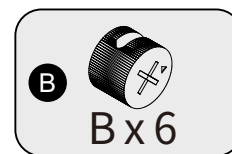
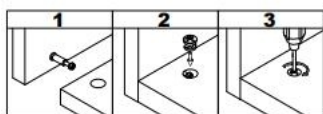

Use Cam Lock (B) attach part (6.7) and part (10) with part (5) , then lock it

# Assembly instructions

## Step 14

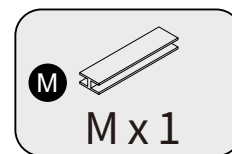
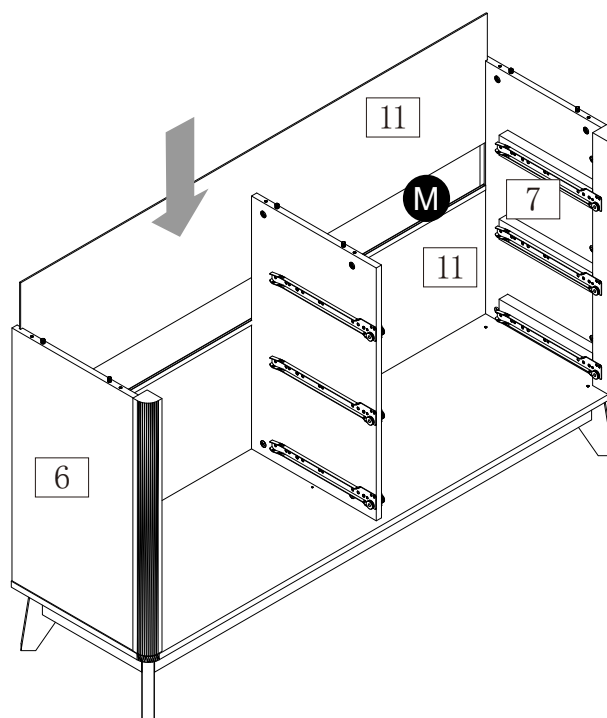

Slide part (11) in part (6.7) .insert part (M) in part (11) .  
Insert part (11) in part (6.7) , then slide it in part (M)

## Step 15

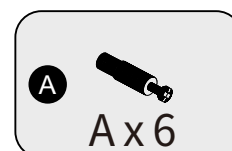
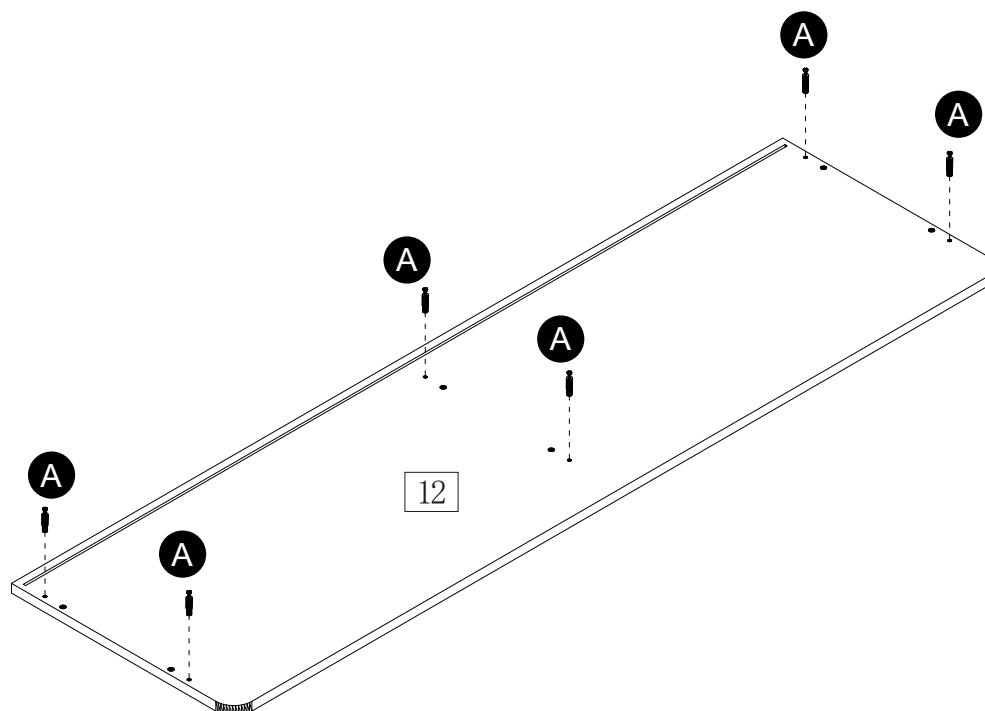

Install Cam Bolt(A)to part(12)

# Assembly instructions

## Step 16

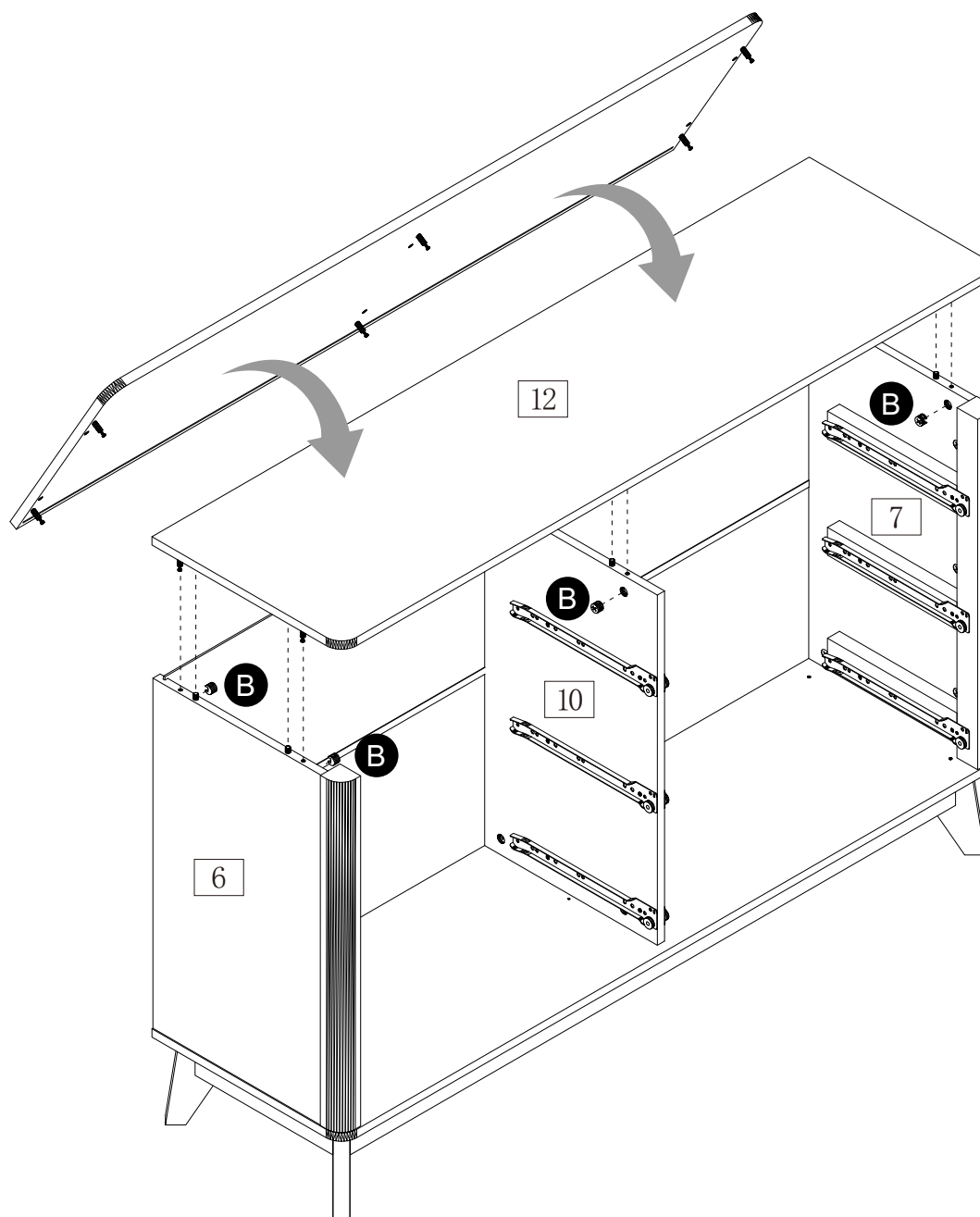
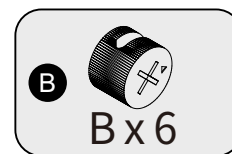
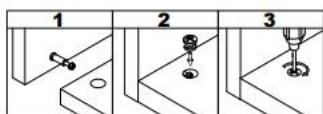

Use Cam Lock (B) attach part (6.7) and part (10) with part (5) , then lock it

# Assembly instructions

## Step 17

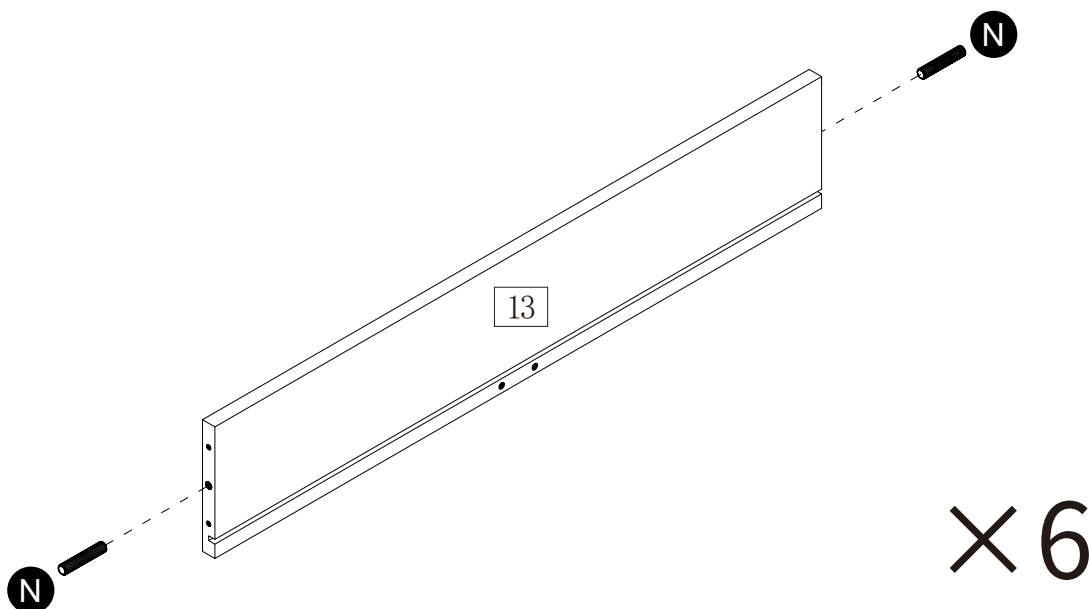

Install Wooden Dowel(N)to part(13)

## Step 18

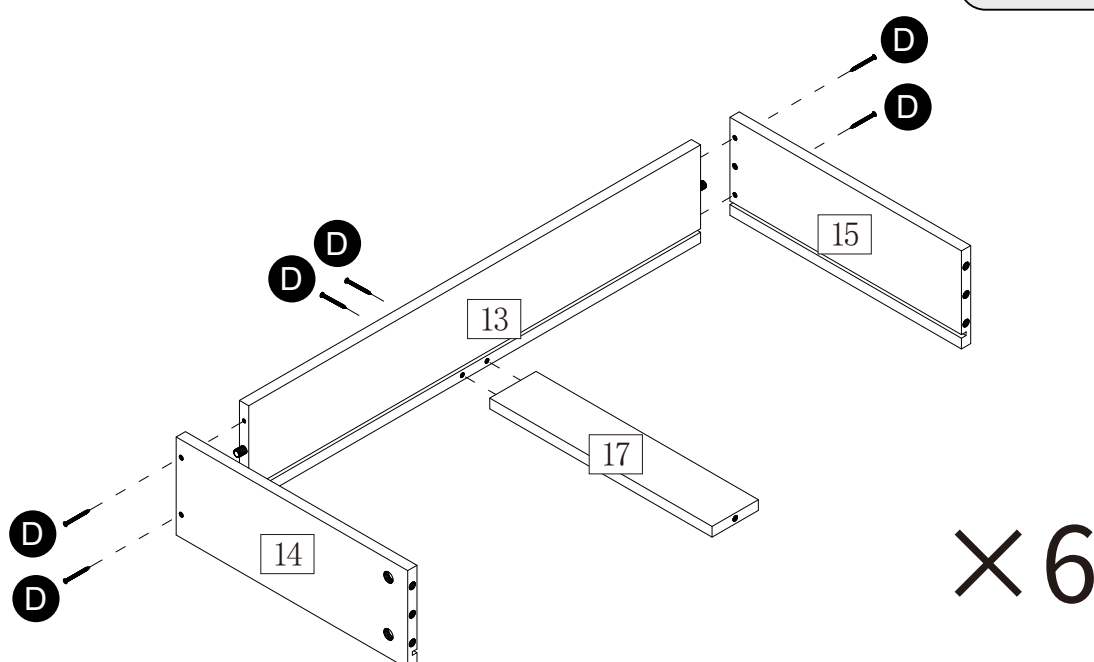
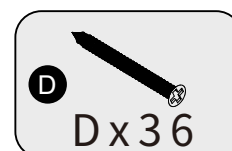

Use Screw(D)to attach part(13)to part(14.15)and part (17) ,then lock it

# Assembly instructions

## Step 19

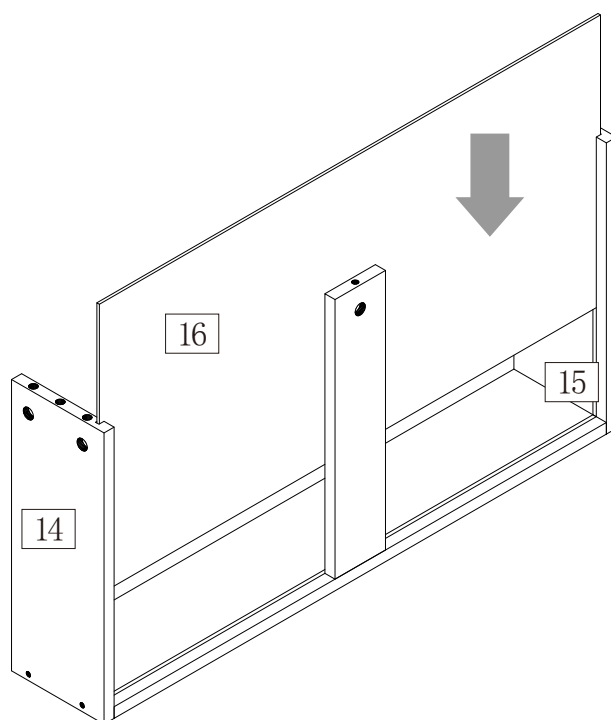

× 6

Slide panel(16)into the grooves as per diagram.

## Step 20

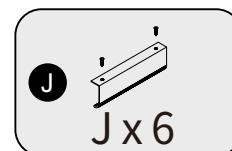
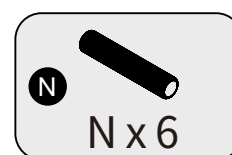
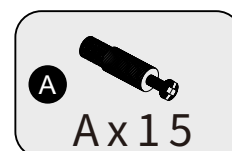
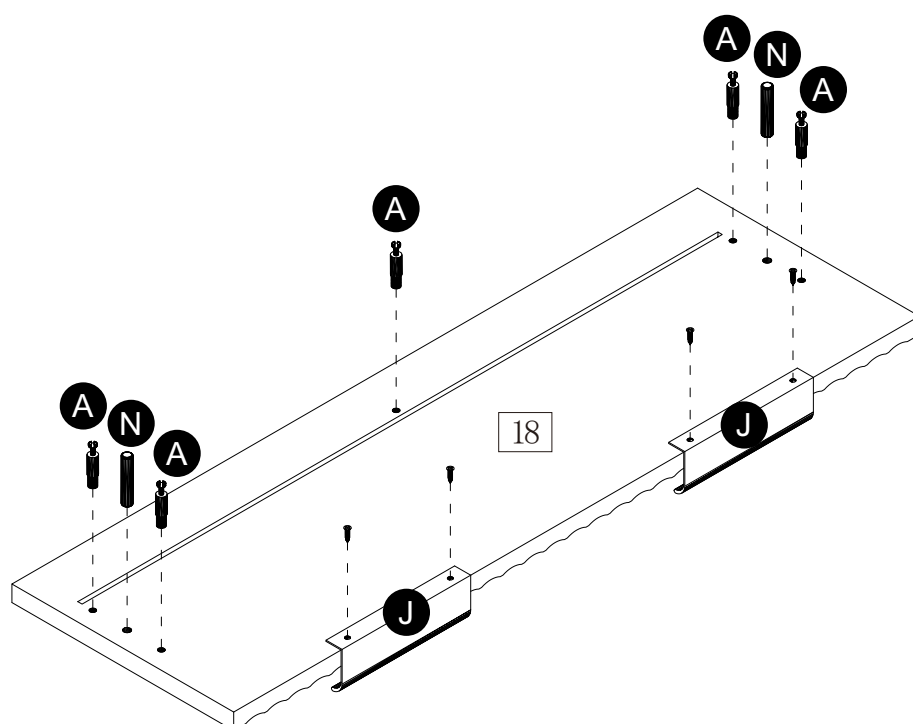

× 3

Install the Cam bolt(A) , Wooden Dowel (N) and handle(J) on the part(18)

# Assembly instructions

## Step 21

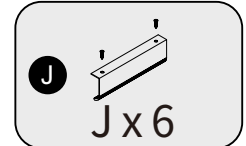
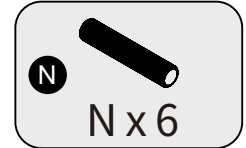
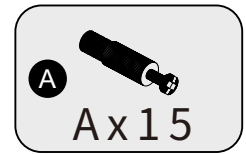
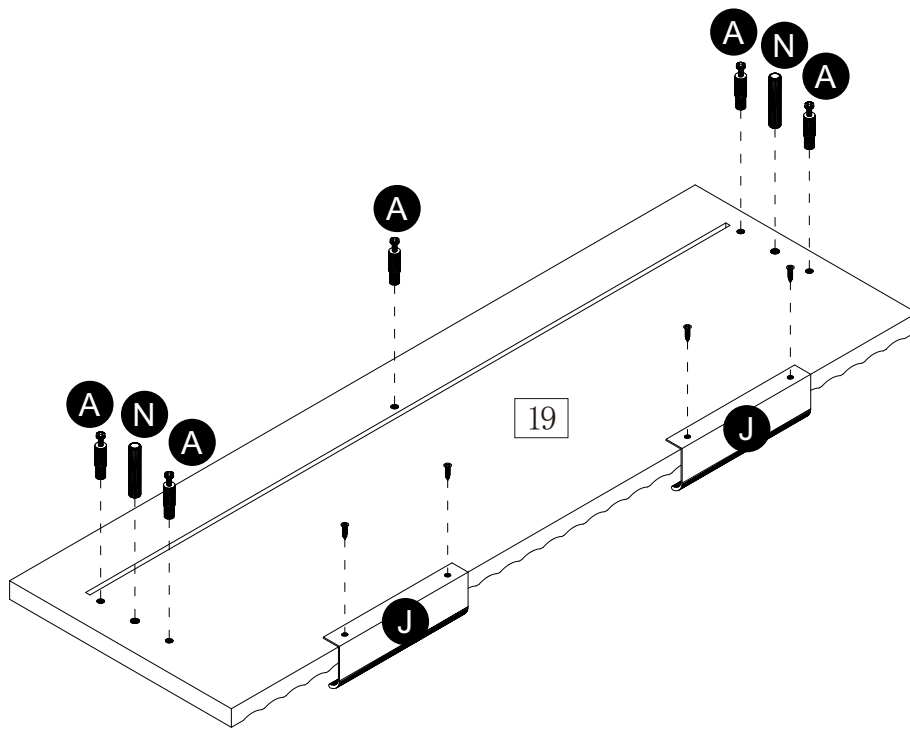

× 3

Install the Cam bolt(A) , Wooden Dowel (N) and handle(J) on the part(19)

## Step 22

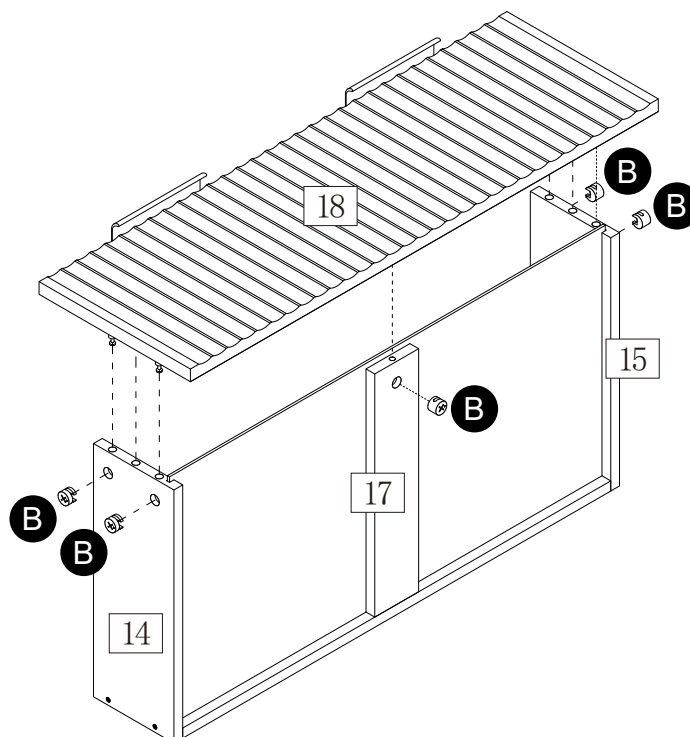

× 3

Use Cam lock(B)to attach part(14.15)on part(17.18),then lock it

# Assembly instructions

## Step 23

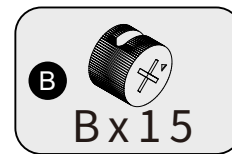
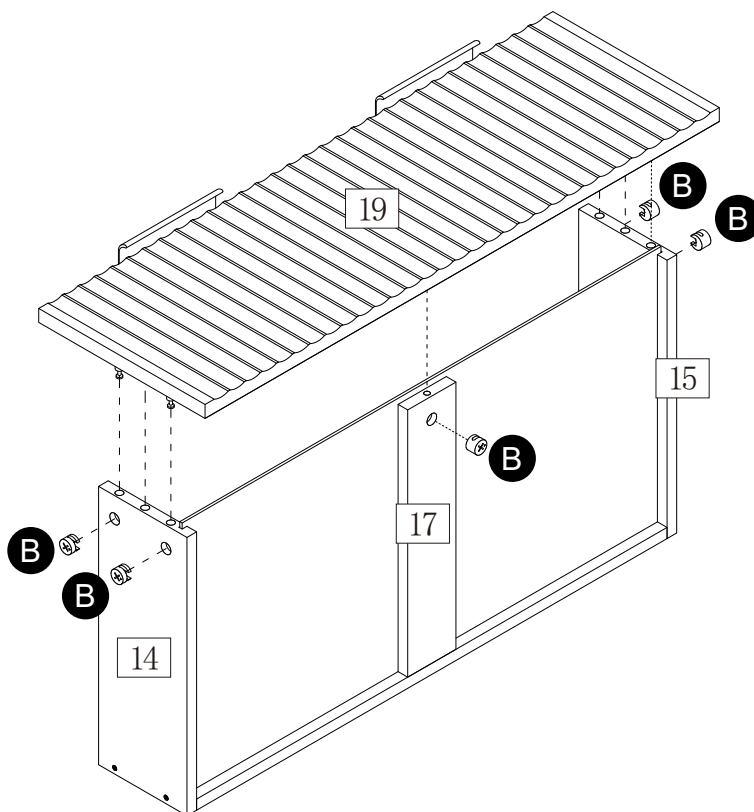

× 3

Use Cam lock(B)to attach part(14.15)on part(17.19),then lock it

## Step 24

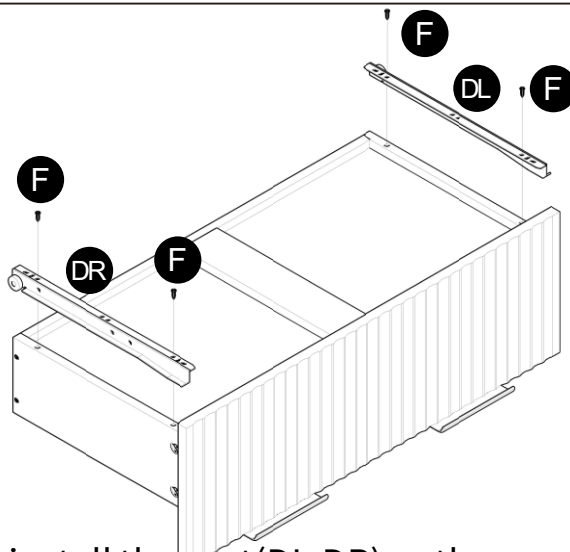
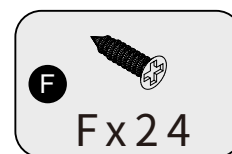
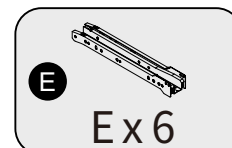
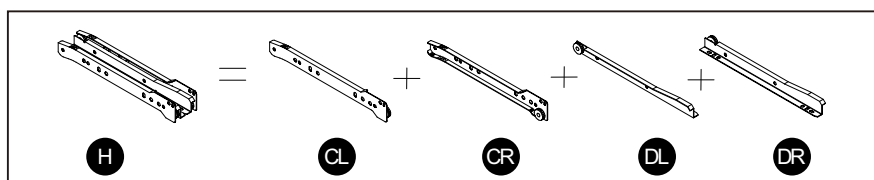

× 6

Use Screw(F)to install the part(DL.DR)on the assembled drawer,pay attention to the difference of right and left

# Assembly instructions

## Step 25

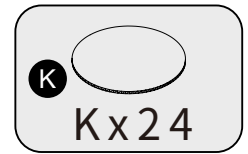
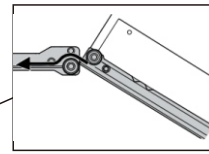
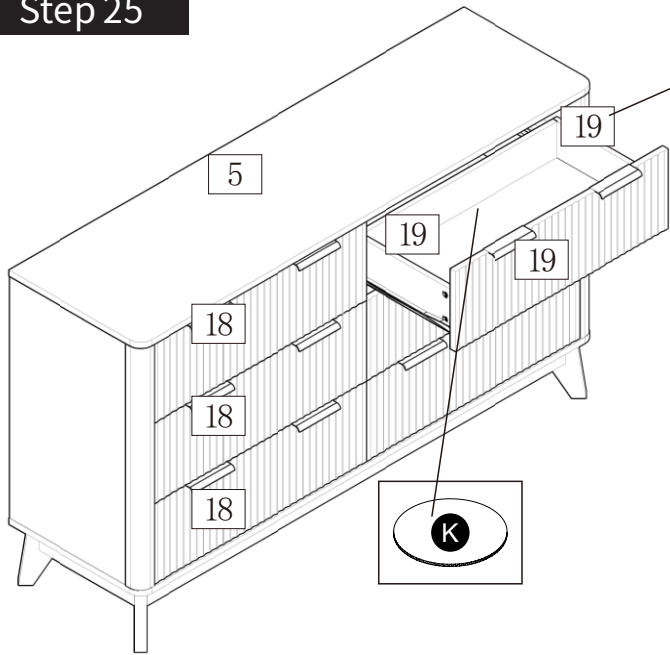

1. Please ensure that you have matched the wheels on BOTH sides of the drawer with the wheels on rails installed BEFORE push in the drawer.

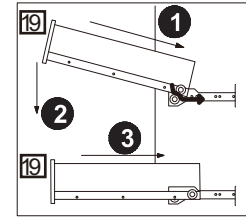

2. If the following occurs, redo the first two steps

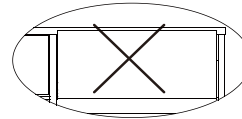

(both wheel are off the rails)

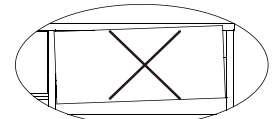

(one wheel is off the rail)

Use sticker(k) to cover screw holes. put on the drawer carbe frustrating if you do it wrong. So, take your time and follow the steps below.

## Step 26

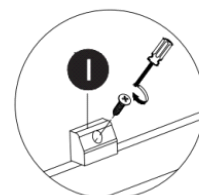
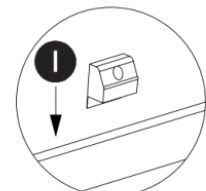
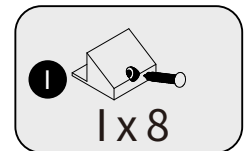
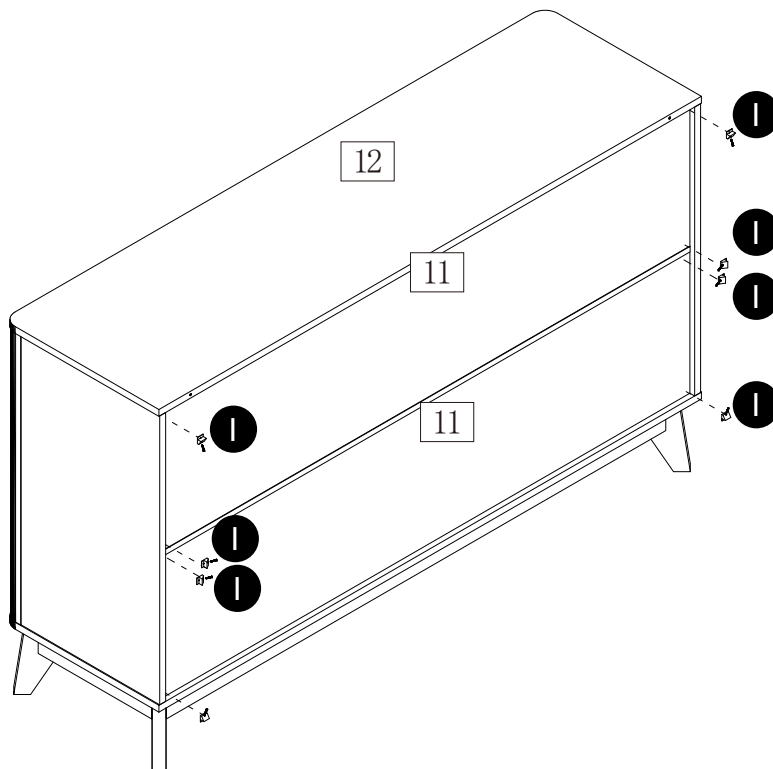

Install the Back Panel Stiffener(I).then lock it

# Assembly instructions

## Step 27

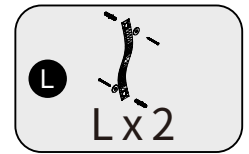

1. The unit is floor standing, but it is recommended that the unit is secured to the wall.
2. Mark the wall with a suitable scribe the position of the fixing holes.

-  **Warning:**  
Before drilling, check wall for hidden pipes and cables.
3. Drill holes and insert 2 x wall plug
  4. Attach 2 x Wall Straps to the top of the unit using 2 x Washers and 2 x Screws
  5. Secure the straps to the wall using 2 x Washers and 2 x Screws
- Note: To hide the straps behind the unit, drill the holes lower than the top of the unit

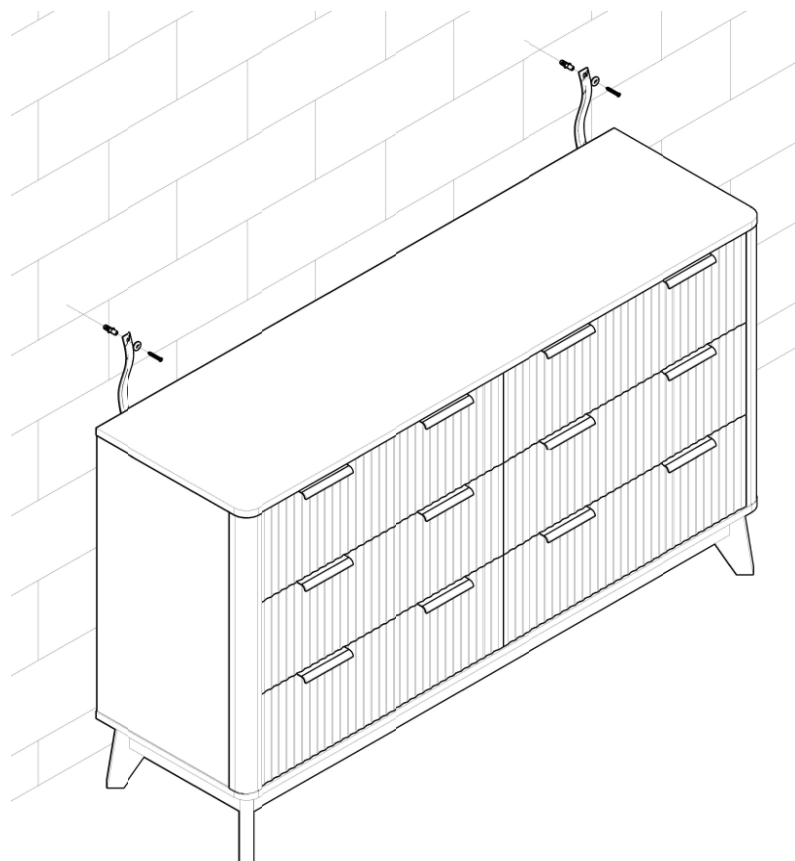
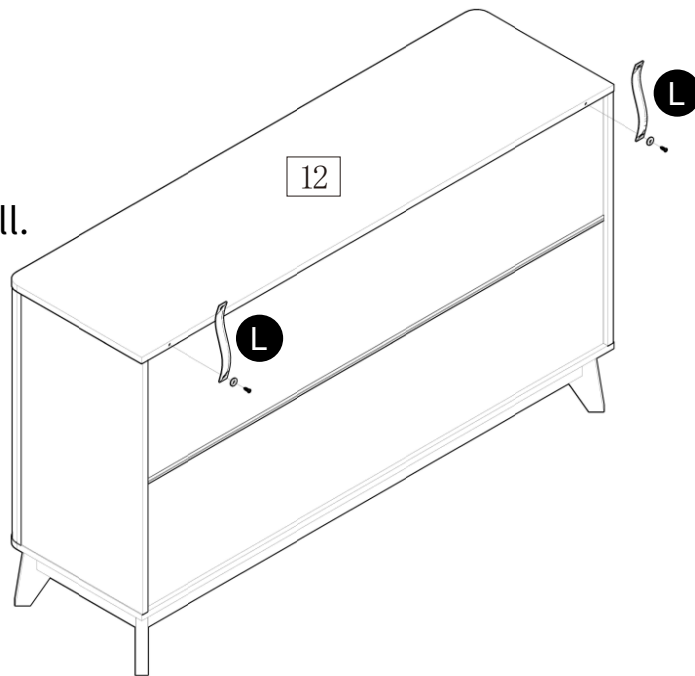

# A Guide to Wall Mounting & Fixings

## Important note:



**Important:** when drilling into walls always check that there are no hidden wires or pipes etc.

If plastic wall plugs (rawl plugs) are supplied with your product, e.g.:



–these are only suitable for use in masonry walls.

If you are in any doubt about the correct wall plugs for your wall, seek professional advice.

Failure of the product due to using the incorrect fixings is the responsibility of the installer.

Make sure that the screws and wall plugs being used are suitable for **supporting your unit**. **Consult a qualified tradesperson if you are unsure.**

Hints:

- 1: General rule:  always use a larger screw and wall plug if you are not sure.
- 2: Ensure you use the recommended drill bit to match the wall plug and hole size.
- 3: Ensure you drill the hole horizontally; do not force the drill or enlarge the hole.
- 4: Take extra care when drilling high walls, ceilings and ceramic tiles. Ensure wall plugs are inserted beyond the thickness of the ceramic tiles to avoid the tiles splitting or cracking.
- 5: Ensure wall plugs are well fitted and are a tight fit in the drilled hole.

## Types of walls

You can use one of the following types of wall plug if your walls are made of brick breeze block, concrete, stone or wood.

No.1 "General Purpose" wall plug

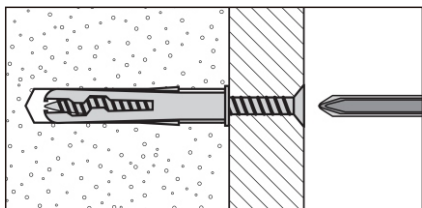

Generally aerated blocks should not be used to support heavy loads, use a specialist fitting in this case. For light loads, general purpose wall plugs can be used.

No.3 "Cavity Fixing" wall plug

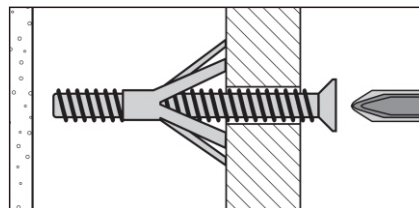

For use with plasterboard partitions or hollow wooden doors.

No.5 "Hammer Fixing" wall plug

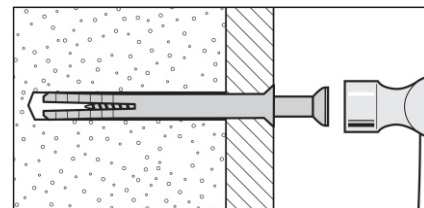

For use with walls stuck with plasterboard. The hammer fixing allows it to be fixed to the wall rather than the plasterboard. Always check the fixing is secure to the retaining wall.

No.2 "Plasterboard" wall plug

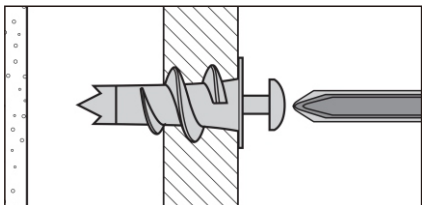

For use when attaching light loads onto plasterboard partitions.

No.4 "Cavity Fixing - Heavy Duty" wall plug

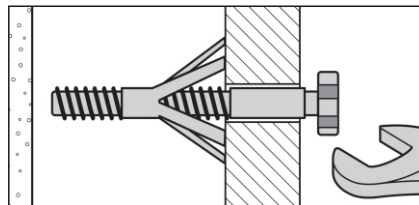

For use when fitting or supporting heavy loads such as shelving, wall cabinets and coat racks.

No.6 "Shield Anchor" wall plug - heavy loads

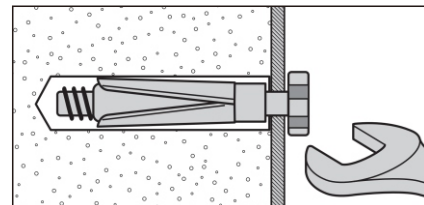

For use with heavier loads such as TV and HiFi speakers and satellite dishes etc.



## Care & Maintenance

**Safety:** always check the fitting and location to ensure your safety in and around the home

**Fitting:** from time to time check the fitting to ensure the wall plugs or screws do not become loose