









Assembly Instruction

Model:M002

Mattress Size:for all size

No.	items	size	pic	qty
1	^{B-B} big bracket			4
2	^{B-B} small bracket	8*10		4
3	^{B-B} screw	8*25		42+2
4	^{C-C} screw	8*50		10
5	^{D-D} adjustable legs	14-26cm		3
6	^{A-A} metal legs	5*7*5cm		22
7	^{A-A} Screw	3cm		118+3
8	^{E-E} bed slat	193*203		1

Reading light switch

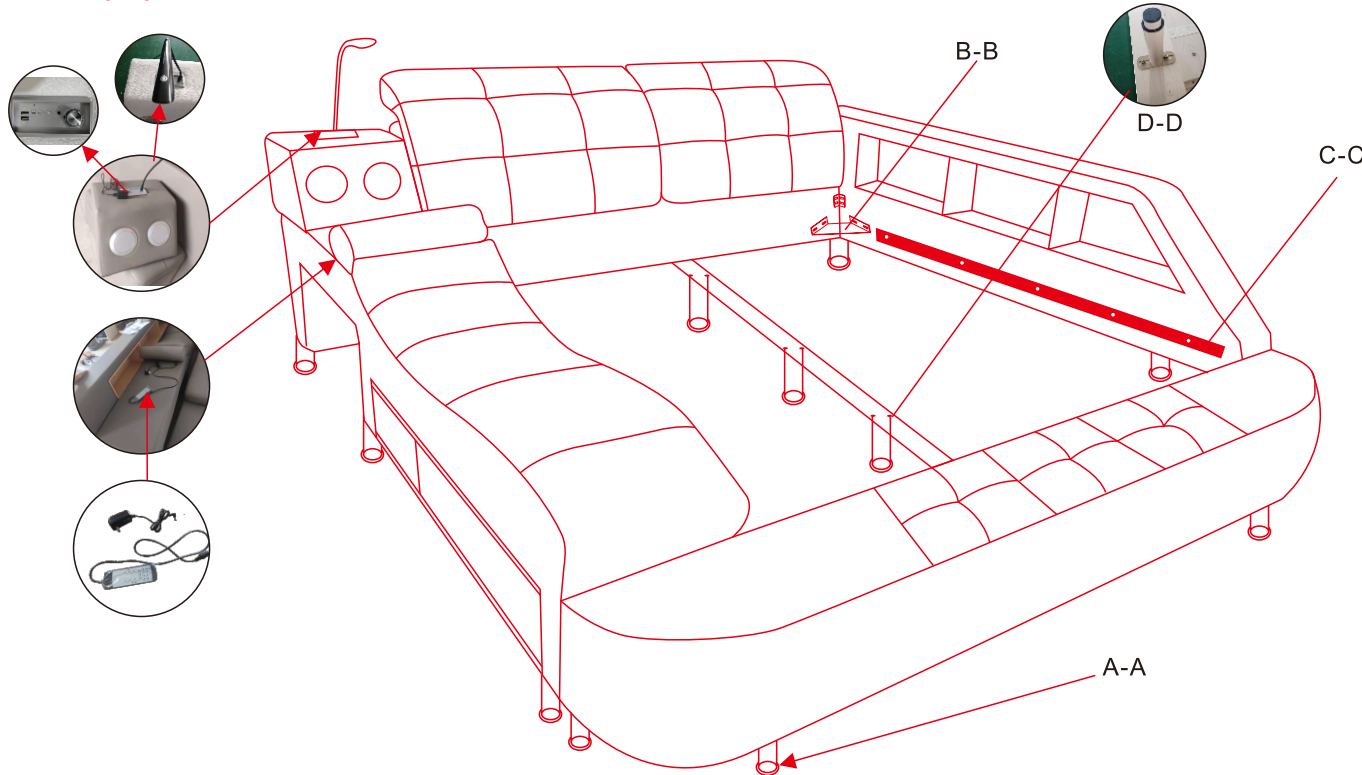

C-Decomposition step

