

# Installation sequence

1

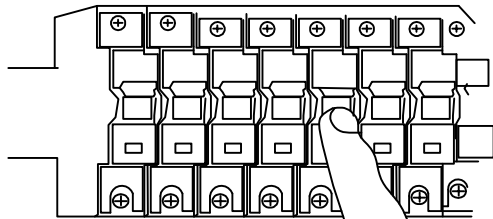

**OFF**

## STEPS

Turn off the power

2

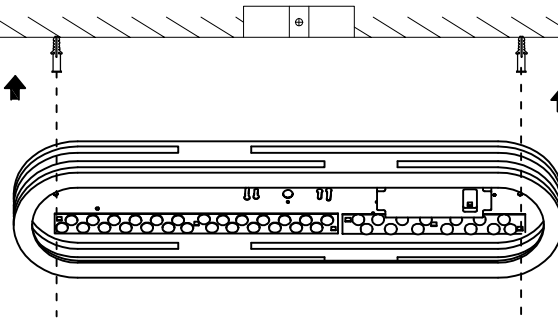

## STEPS

Drill pilot holes in the ceiling according to the self tapping screw holes on the fixture base, then insert the expansion anchors

3

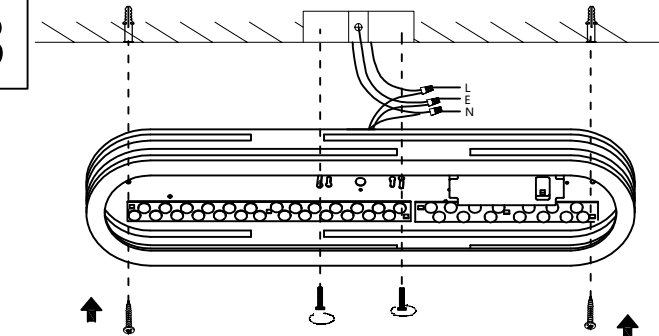

black L  
white N  
Earth E

## STEPS

1. Connect the fixture wires to the reserved power supply wires using wire connectors. Make sure to match the live, neutral, and ground wires correctly.  
2. Fix the fixture to the junction box and the ceiling using the mounting screws and self-tapping screws.

4

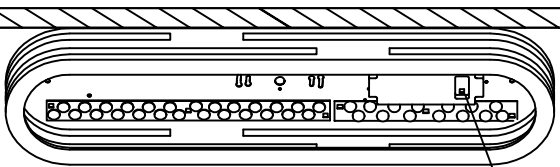

Can be used to change color temperature

- 1 3000K
- 2 3500K
- 3 4000K
- 4 5000K
- 5 6000K

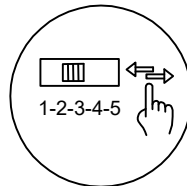

## STEPS

Use the switch on the driver to select the color temperature (make sure the power is turned off before adjusting).

5

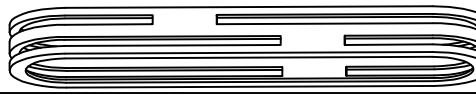

## STEPS

1. Remove the lampshade from the packaging  
2. Place it into the lamp body with both hands

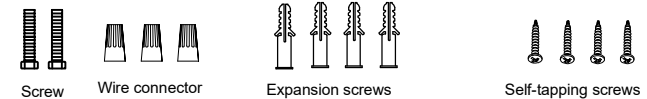

Before installation, please check whether the accessories are complete. If you have any problem, please contact our customer service in time.

## Note:

1. Voltage: 120V-50-60Hz
2. Bulb Type: LED
3. Before installation, please cut off the power supply to prevent electric shock.
4. Please be sure the installation step according to the company's instructions.