

SECTIONAL SOFA

082 (8029)

USAGE GUIDELINES

(To use this product, please read this User Guide carefully)

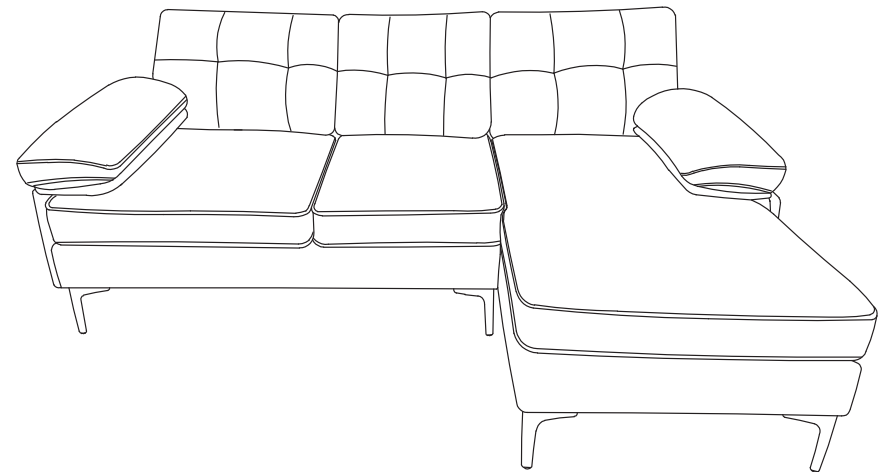

CATALOGS

Dear friends.

Thank you for using our products, in order to facilitate your correct operation of this product, please read this user guide carefully before use, and store it in a fixed place so that you can consult it in the future.





Basic Product Parameters -----	01
Unpacking List -----	01
Installation instructions -----	04
Transport and installation -----	11
Caveat -----	11
Methods of care -----	13



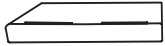
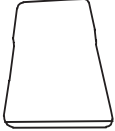

PREAMBLE

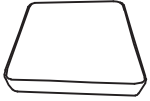
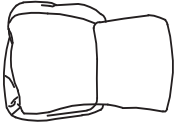
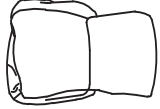
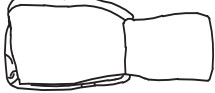
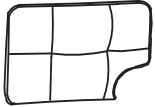
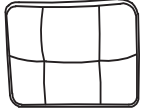
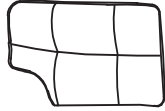
BASIC PRODUCT PARAMETERS



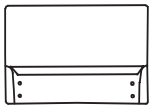
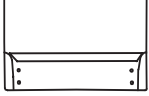

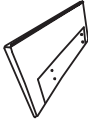
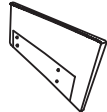

BRAND NAME	SECTIONAL SOFA
MODEL NUMBER	082 (8029)
SIZES	211CMX138CMX87CM
MAKERS	Zhejiang Eskimo Technology Co., Ltd.
COMPANY ADDRESS	Building 4, No.63 Jiujuan Road, Shangcheng District, Hangzhou City, Zhejiang Province , China.

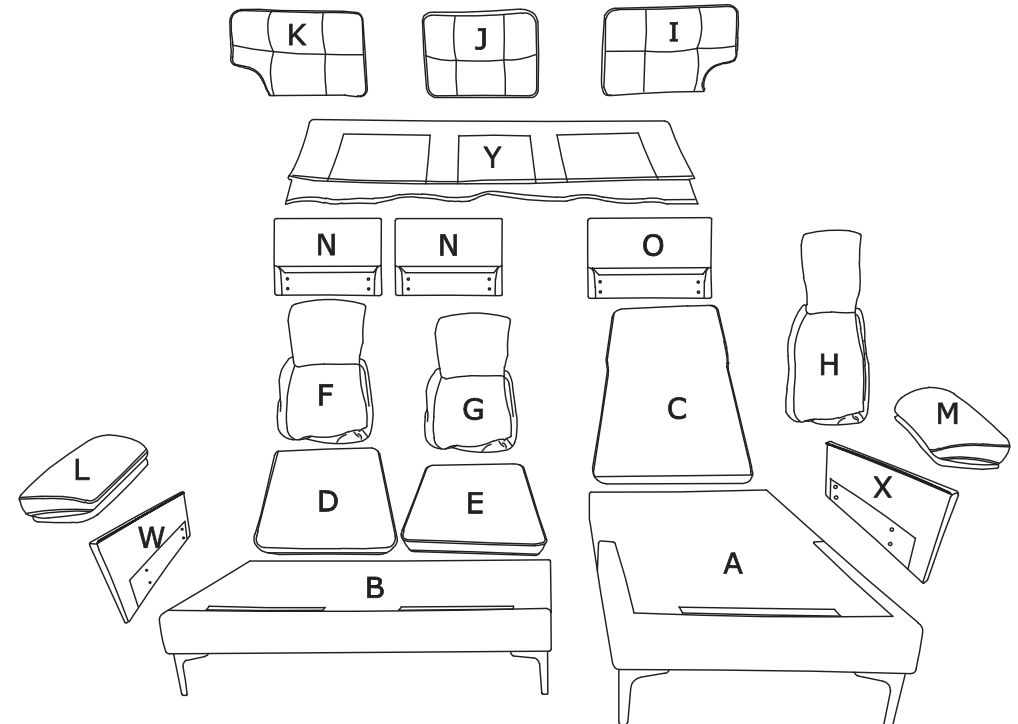
UNPACKING LIST

A RSF Seat  1PC	B Love Seat  1PC	C RSF Chaise Cushion  1PC	D LSF Seat Cushion  1PC
E Middle Seat Cushion  1PC	F LSF Seat Cover  1PC	G Middle Seat Cover  1PC	H RSF Chaise Cover  1PC
I RSF Back Cushion  1PC	J Middle Back Cushion  1PC	K LSF Back Cushion  1PC	L Left handrail  1PC

M Right handrail  1PC	N Chair Backrest  2PCS	O Chair Backrest  1PC	P Leg  8PCS
W Armrest (Left)  1PC	X Armrest (Right)  1PC	Y Back Cover  1PC	





- P  8X Sofa Leg
- Q  16XBolt 8*18mm
- R  12XBolt 8*65mm
- S  10XBolt 8*80mm
- T  12X Butterfly Nut
- U  24X Flat Washer
- V  1X Allen Key M5

TOOLS REQUIRED:  SCISSORS (NOT INCLUDED)

INSTALLATION INSTRUCTIONS

step 1

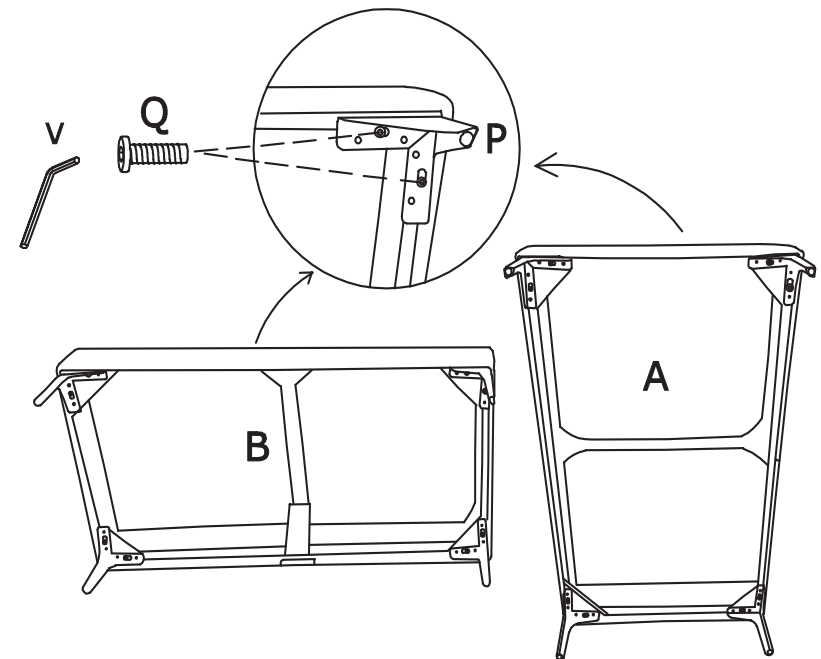

Q	 M8X18mm	16PC
P		8PC

Assemble iron leg (P) with bolts(Q)



INSTALLATION INSTRUCTIONS

step2

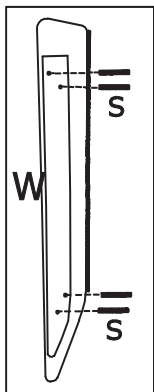
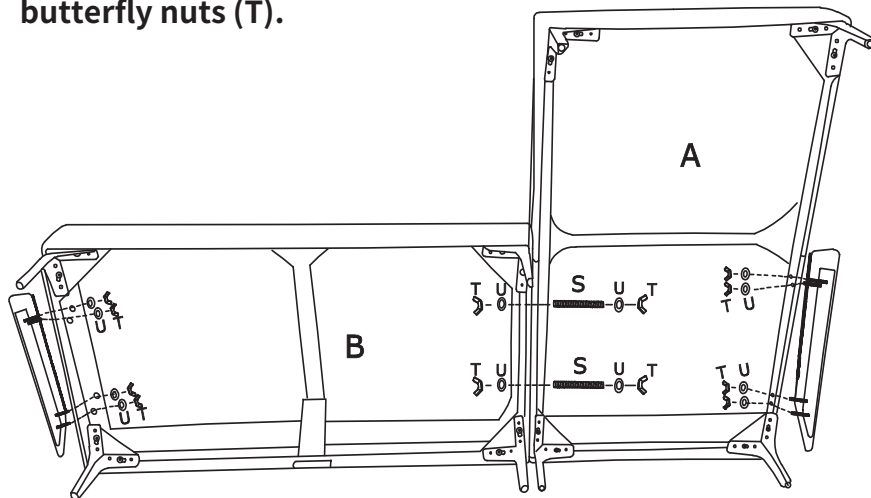

S	 M8X60mm	10PC
T		12PC
U		12PC

Assembly handrail (w)(x) with bolts (S) flat Washer (U) butterfly nut (T) assembly.
Then assemble the seat frame with screw (S) washers (U) butterfly nuts (T).



INSTALLATION INSTRUCTIONS

step3

R	 M8X65	12PC
U		12PC

Fixed back frame (N) and (O) with bolts (R) and flat gaskets (V).

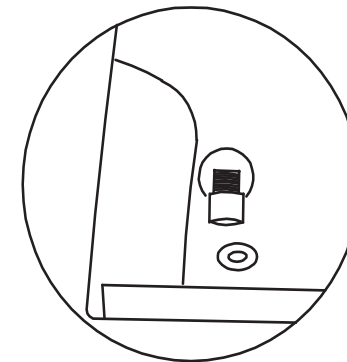
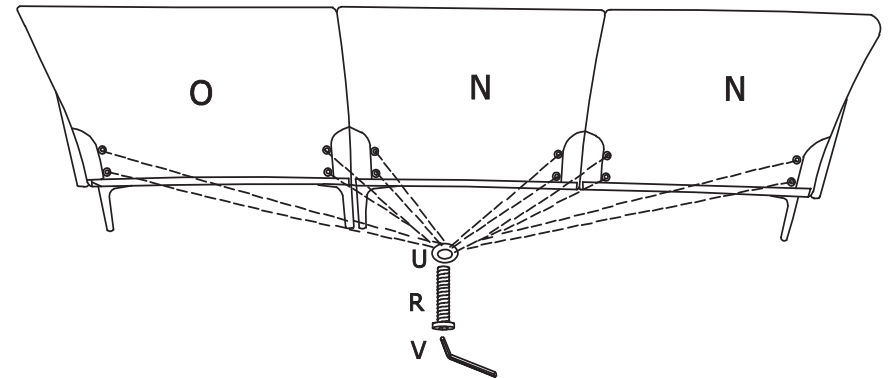

INSTALLATION INSTRUCTIONS

step4

Put the Back Cover on the back frame.

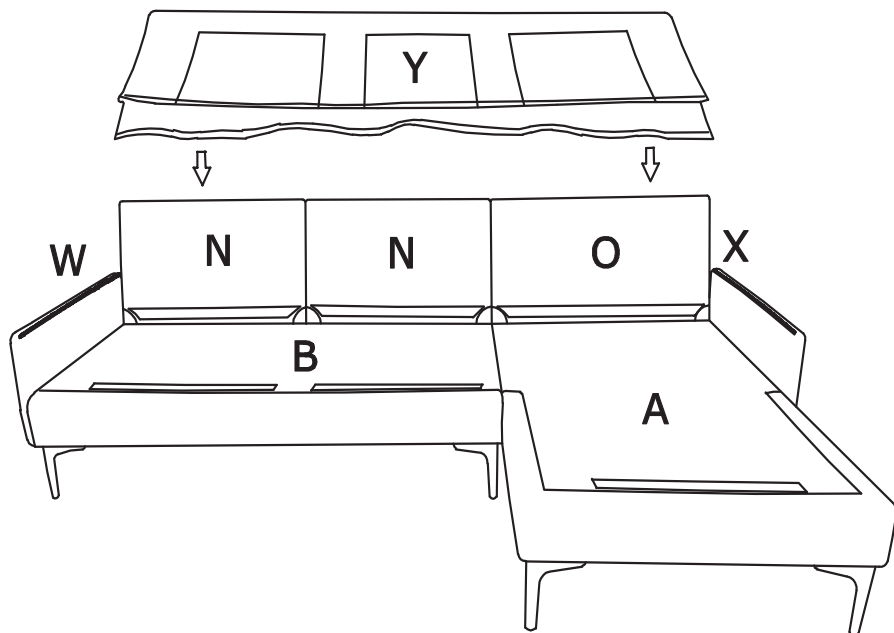

INSTALLATION INSTRUCTIONS

step5

The cushion is packaged by vacuum compression .
After cutting the package,it rebounds quickly within 10s.
If the fabric has wrinkles,it wil basically disappear after
standing for 72 hours

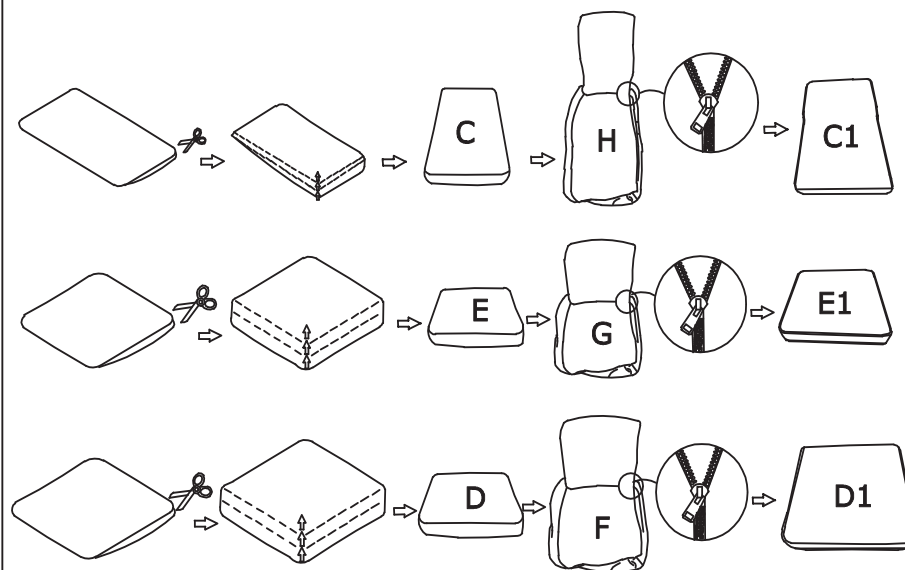

Please align the chain first and then pinch the zipper
gently and close it smoothly

INSTALLATION INSTRUCTIONS

step6

Put the seat cushion on the sofa first, then pull up the left arm(L)Zipper for right handrail (M).

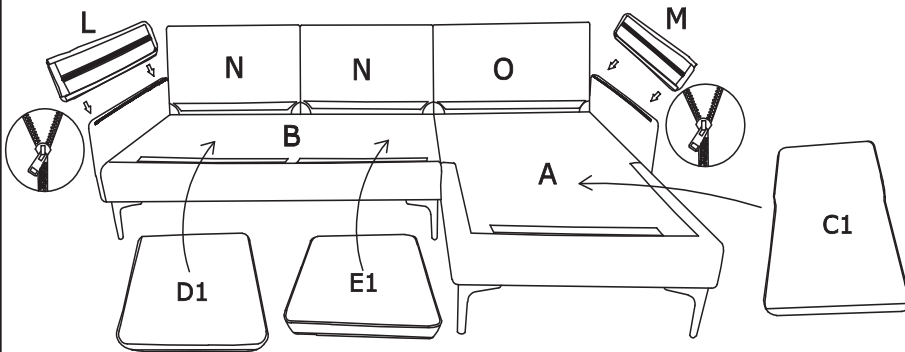

step7

Put the backpack on the sofa.

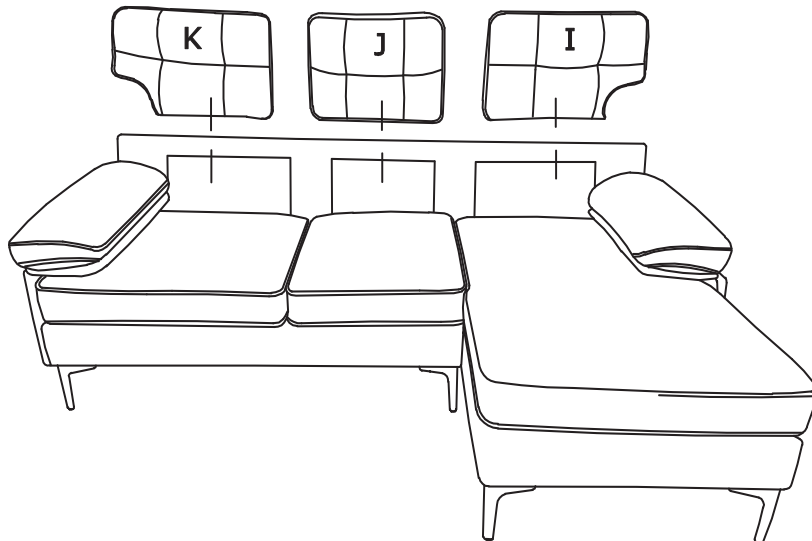

INSTALLATION INSTRUCTIONS

step8

If the fabric has wrinkles, placing 72 hours will basically disappear.
Well done! !
You can now enjoy your leisure time on the sofa.

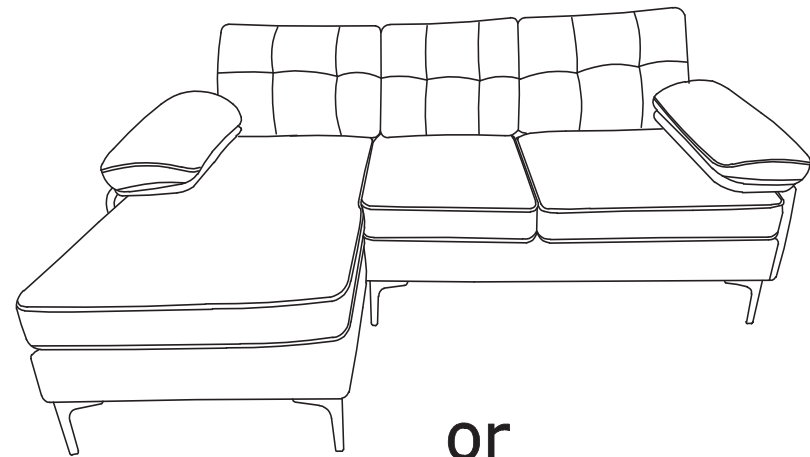

or

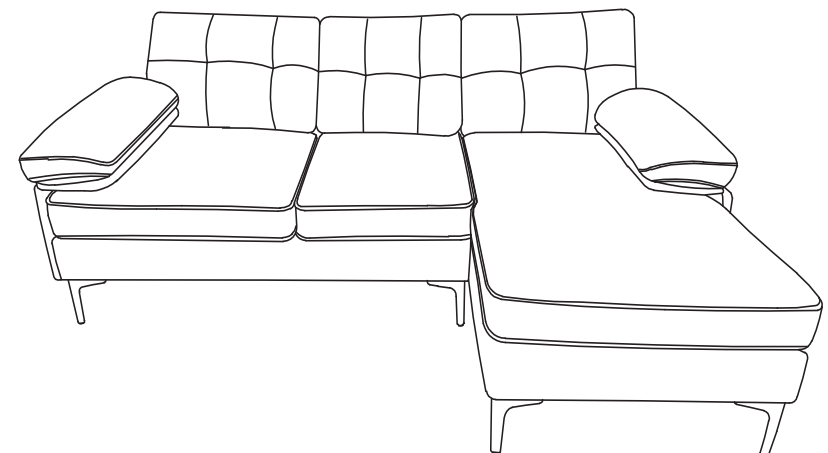

TRANSPORT AND INSTALLATION

1. The sofa should be especially protected against rain, moisture and crushing by heavy objects during transportation, in order to avoid quality problems during use.
2. Please make sure that the sofa has the safe access required for its entry before it enters your place of use.
3. Sofas are mainly fixed installation, a few are dismantling sofas. When purchasing a sofa, please give full consideration to the size of the door frame and the movable space of the entrance door. If necessary, ask a professional to disassemble the sofa and reassemble it after entering the house, so that it will not damage the sofa's internal structure, seating sensation and surface effect.

CAVEAT

Please read all instructions before use.

If in any doubt about safety, contact a specialized technician for inspection. When using this product, basic safety precautions must be observed to avoid the risk of injury to persons, including the following.

1. Do not use this product in high humidity environments.
2. Do not store or use this product outdoors or in direct sunlight.

3. Someone must be present to watch over children, disabled people or people with reduced mobility when they are near or using the sofa.
4. After using the sofa, please turn off the on/off function of the backrest/footrest completely before getting up to avoid accidents.
5. Do not sit on the footrest when using the massage sofa to avoid accidents.
6. Do not try to stand on the armrests or backrests to avoid the massage sofa toppling over, this may cause an accident.
7. Always keep the sofa clean and avoid inserting other objects into the gap of the sofa.
8. Please ensure that there are no other obstacles under the footstool or backrest when lowering it, especially for children.

It is not recommended that children use the appliance alone. The following aspects must be considered.

1. Do not allow children to play freely on the sofa alone without adult supervision to be! Limbs may get caught in the seams of the product and the sofa may tilt and cause the child to fall.
2. Do not leave children unattended near the sofa when it opens and closes to avoid unnecessary injuries.

METHODS OF CARE

1. Avoid placing the sofa in direct sunlight above 30°C. Every 10-15 days, use a vacuum cleaner to remove dust etc. and clean the entire sofa.
2. Remove stains as soon as they are stained and avoid scratching or other damaging treatments, thus permanently maintaining the quality of the fabric surface. The surface of the sofa can be covered with a tight-fitting protective cover. When stained with ink-like stains, wipe with a soft white cloth or absorbent paper.
3. If a solvent is to be used to remove a stain, avoid applying it directly to the stain, but pour it onto a clean cloth first and then try to clean the hidden areas on the back. The stain should be wiped in a circular motion from the outside in until it is completely removed. Immediately after wiping, a low-power hair dryer should be used to dry the clean area from the outside in.
4. Be gentle and careful when wiping stains and spots, do not use excessive force. The massage sofa can be covered with a removable, tight-fitting protective cover.
5. If you have covered the sofa with a tight-fitting protective cover, please follow the instructions listed on the cover and clean it with a cleaner that does not contain bleach or oxidizing agents. Other-

wise the texture and color of the fabric will change.

6. Vacuum regularly:

Vacuum once a week, paying special attention to removing dust between fabric folds. If there are stains, wipe with a dampened clean cloth to avoid leaving traces, preferably from the edge of the stain.

7. How to clean effectively:

Generally speaking, a soft cotton cloth can be moistened with a 1:10 soap flake solution or 1:20 advanced shampoo, wrung out and gently wiped the stained area. If the stain is too heavy, repeat the process a few times and the stain will be removed. Don't use too much force or the fabric will fade.

8. How to remove stubborn stains:

If the sofa is stuck with chewing and other gelatinous substances, use an ice pack or ice water to cool it down, and then gently wipe it off with a fine silk cloth.