

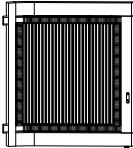

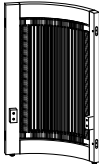
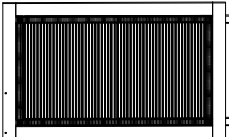
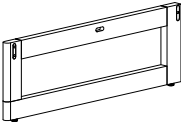
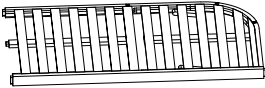
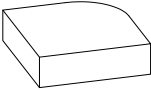
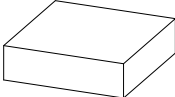

Hello! Please read these important attentions...

Please put a thick carpet on the ground to protect the furniture finish and corners. During the installation process, **DON' T** fasten screws tight 100% at a time.

ASSEMBLY INSTRUCTIONS

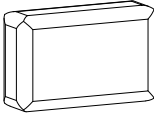
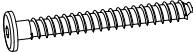
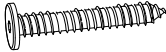
NUMBER	COMPONENT	QUANTITY
A	 <p>LEG FRAME 1</p>	1PC
B	 <p>LEG FRAME 2</p>	1PC
C	 <p>LEG FRAME 3</p>	1PC
D	 <p>LEG FRAME 4</p>	1PC
E	 <p>SEAT</p>	1PC
F	 <p>SEAT CUSHION 1</p>	1PC
G	 <p>SEAT CUSHION 2</p>	1PC

ASSEMBLY INSTRUCTIONS

NUMBER	COMPONENT	QUANTITY
H	 BACK CUSHION	2PCS
I	 SCREW M7x70MM	5PCS
J	 SCREW M7x50MM	2PCS
K	 SCREW M6x40MM	4PCS
L	 SCREW M4x20MM	8PCS
M	 PLASTIC LID	4PCS
N	 M4	2PCS

NOTE: The accessory pack does not include a screwdriver. Please prepare a screwdriver before you assemble.

ASSEMBLY INSTRUCTIONS

1

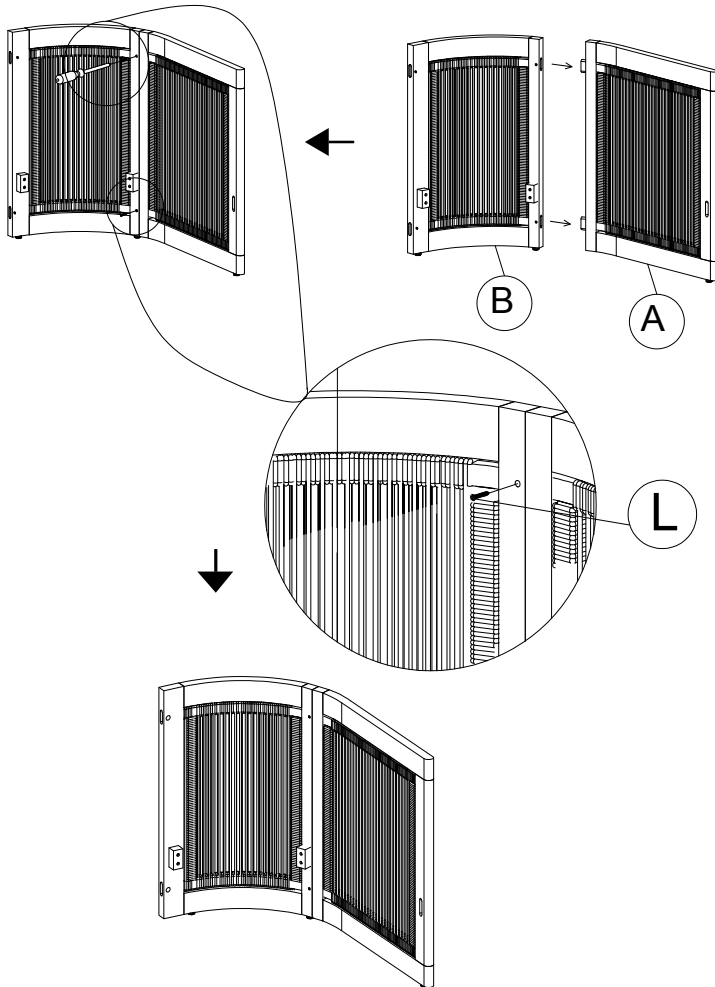

Use the Screws M4X20 MM (L) to connect with the Leg Frame 1 (A) and Leg Frame 2 (B) together to make the Left Leg Cluster.

ASSEMBLY INSTRUCTIONS

2

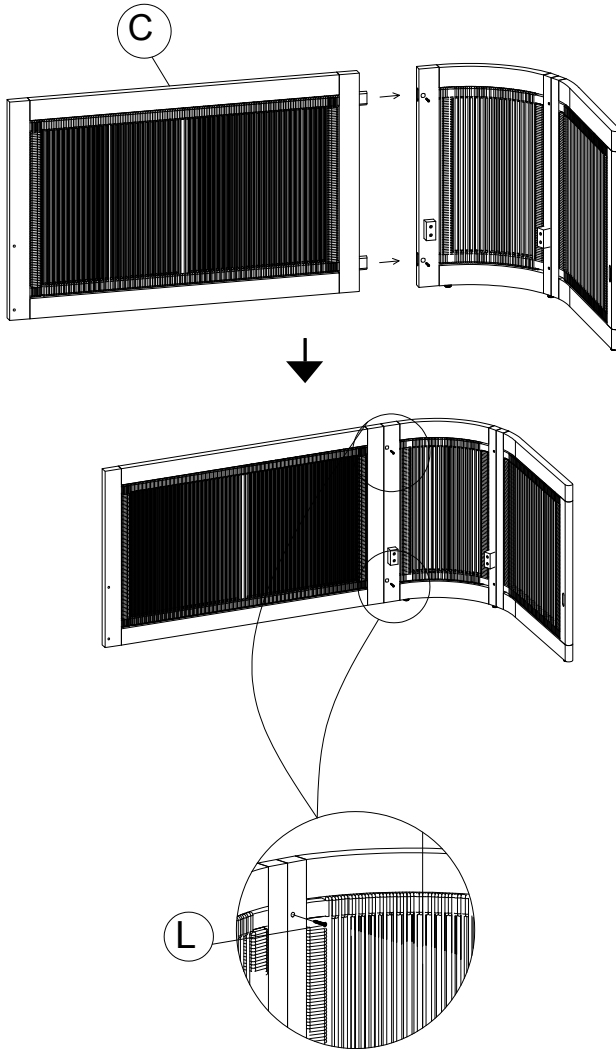

Use the screws M4X20 MM (L) to connect the Left Leg Cluster (Step 1) to the Leg Frame 3 (C) to make the Leg Cluster.

ASSEMBLY INSTRUCTIONS

3

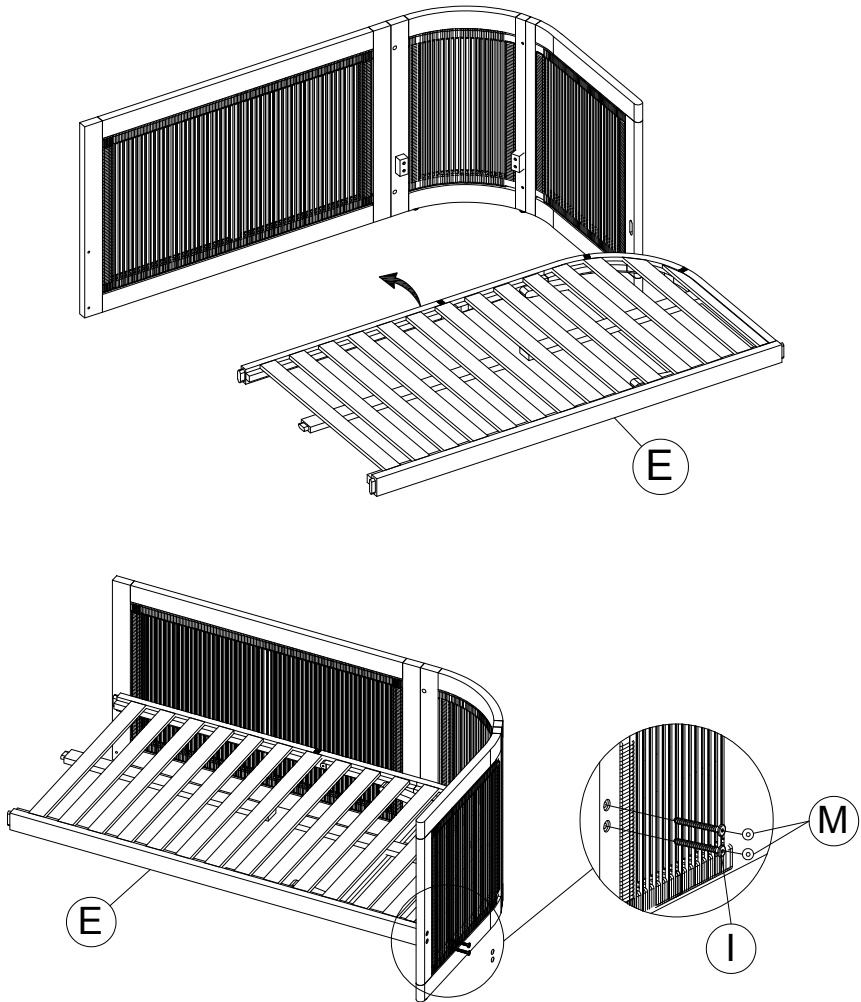

Use the screws M7X70 MM (I) to connect the Leg Cluster (Step 2) to the seat (E) together then use the plastic lid (M) to cover the screw Heads.

ASSEMBLY INSTRUCTIONS

4

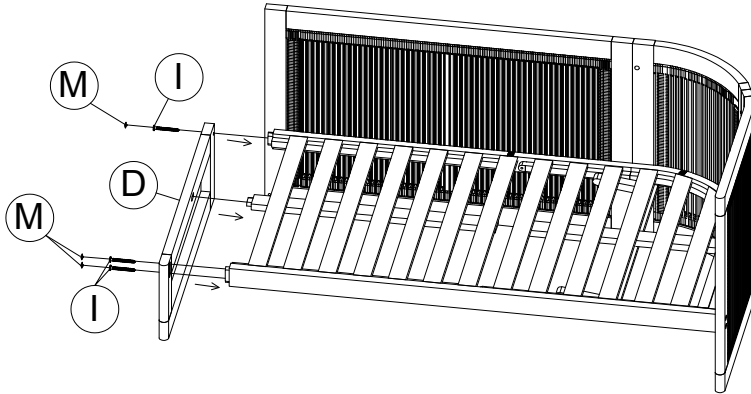

Use the screws M7X70 MM (I) to connect with the Leg Frame 4 (D) to the seat (E) together then use the plastic lid (M) to cover the screw Heads.

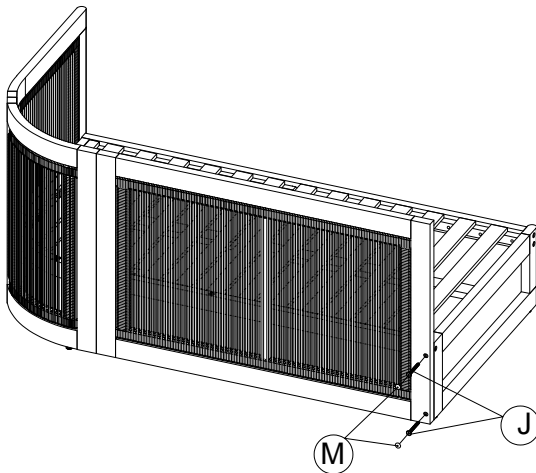

Use the screws M7X50 MM (J) to connect to The Leg Frame 4 (D) then use the plastic lid (M) to cover.

ASSEMBLY INSTRUCTIONS

5

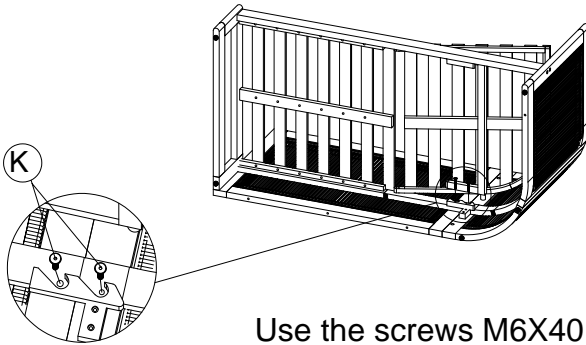

Use the screws M6X40 MM (K) to connect the Leg Frame 4 to the Seat (E) together.

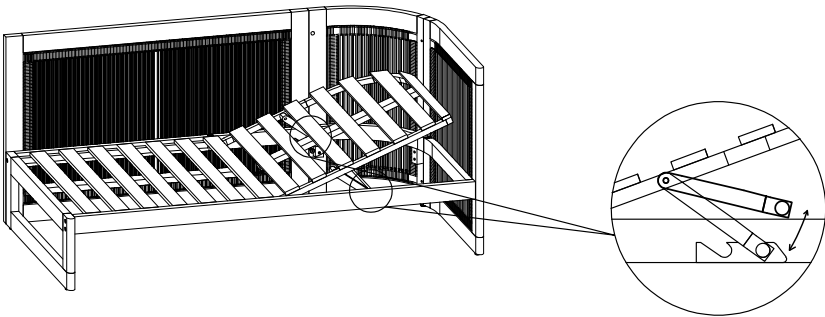

Raise or lower the seat backrest.

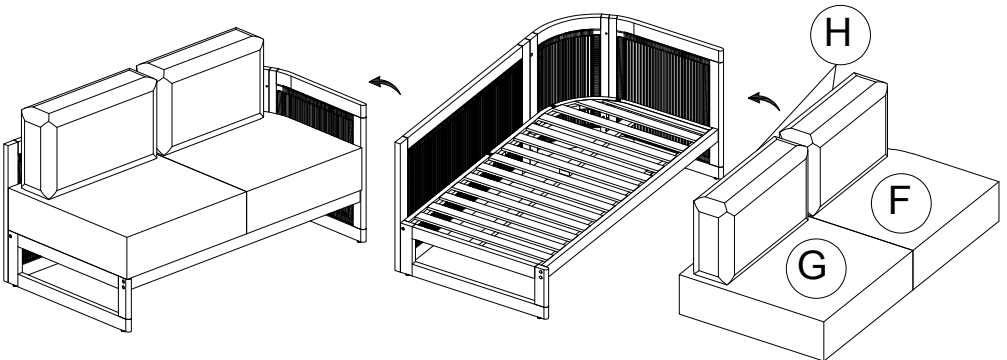

Put the Back and Seat Cushion on the Sofa.

ASSEMBLY INSTRUCTIONS

6

