

WARNING 

PLEASE READ ALL SAFETY WARNINGS AND INSTRUCTIONS CAREFULLY. PLEASE INSPECT ITEMS CAREFULLY BEFORE ATTEMPTING TO INSTALL.







QUICK RESPONSE SERVICE

We constantly strive to provide the high-quality products and excellent customer service to achieve our customer satisfaction.

SPECIFICATION PARAMETERS

* Material: Rattan and Fabric

PACKING LIST

PIECE	DESCRIPTION	PICTURE	QUANTITY	PIECE	DESCRIPTION	PICTURE	QUANTITY
A	Lamp Body		1X	D	Lamp Shade		1X
B	Socket Assembly		1X	E	Finial		1X
C	Harp		1X	F	Bulb		1X

INSTALLATION STEPS

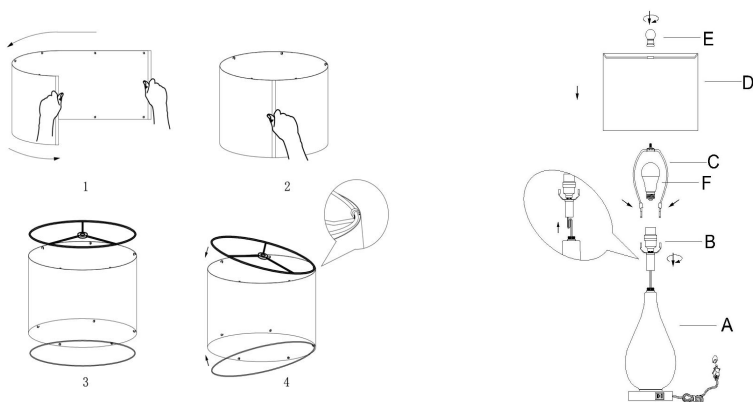

- Step 1: Attach the round lampshade
- Step 2: Clip the round metal piece in the hook

- Step 3: Install the bulb(F) on the socket.
- Step 4: Assemble the lampshade(D).
- Step 5: screw the finial(E) into the harp(C).

WARRANTY POLICY

Warranty: 1 Years Warranty, We offer a 24 hour online service, if you have any questions, please feel free to contact us.