

INSTRUCTION MANUAL

Dog House

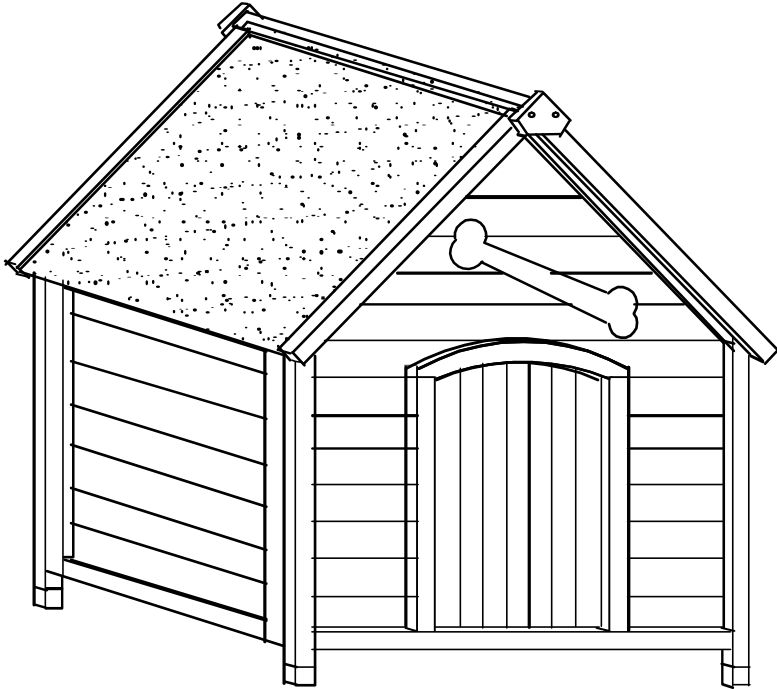

Dear Customers:

Thank you for purchasing our product. Please read this instruction manual carefully after unpack the carton.

If any parts are missing, **DO NOT RETURN THIS PRODUCT OR CALL THE RETAILER.**

GUIDE OF MANUAL

1. The dog house may have burrs due to the nature of the wood.
Please wear gloves to avoid injury during installation.
2. If you use a power tool to tighten the screws, the speed should not be too fast which will cause a wood crack.
3. The surface of the dog house is delicate and natural, and the wood is soft. Try to avoid strong collisions during use.
4. Avoid prolonged exposure to the sun and rain, which can prolong the service life.

PARTS LIST

Before assembly, check to ensure the proper quantity of all parts.

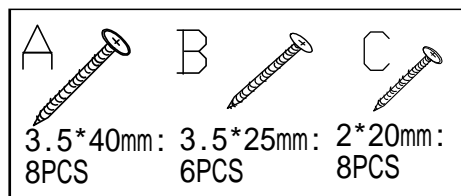
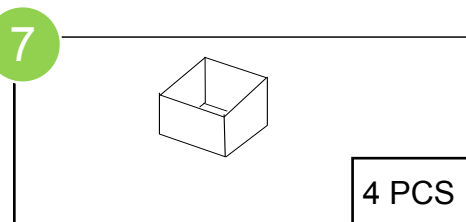
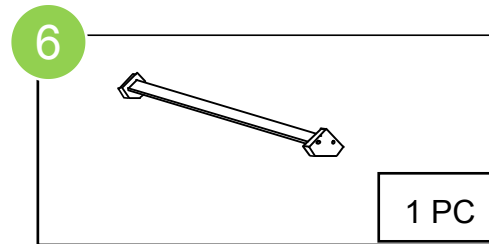
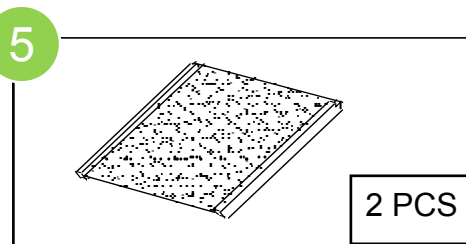
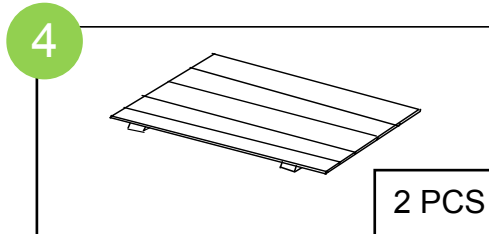
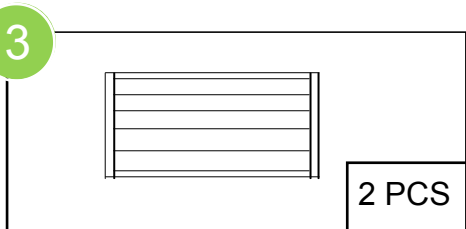
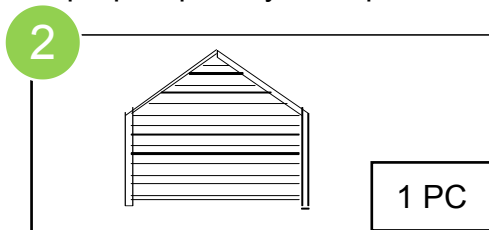
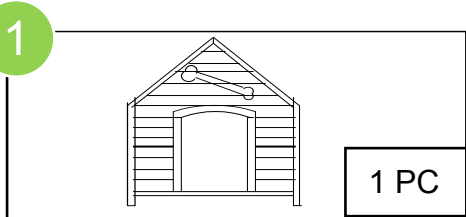

PRODUCT ASSEMBLY

- 1** Installing front panel 1 * 1pc with side panels 2* 2pcs.

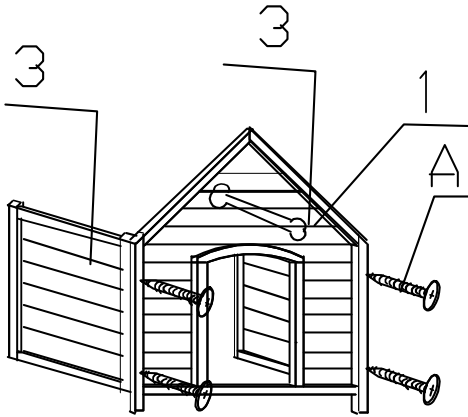

Use screw A * 4pcs to secure them.

- 2** Install the back panel 2 * 1pc with side panels.

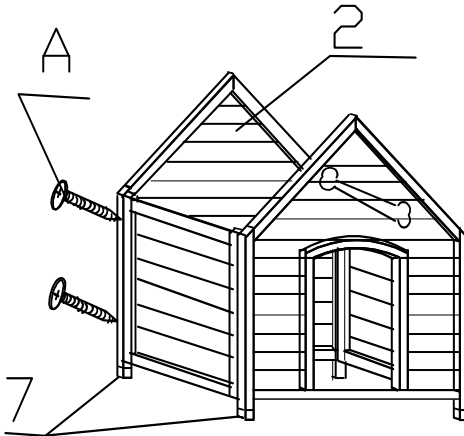

Use screw A * 4pcs to secure them.

Then insert the black plastic foot pad 7 * 4pcs.

PRODUCT ASSEMBLY

- 3** Place the bottom panels 4 * 2pcs inside the dog house.

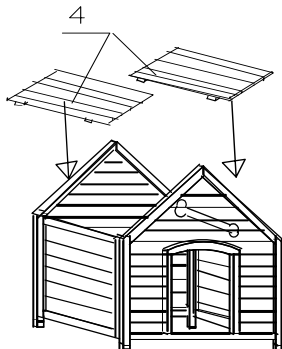

- 4** Place the Asphalt roof 5 * 2pcs to the top of the house, then attach part 6 * 1pc to them, and use screw B * 6 pcs to secure them.

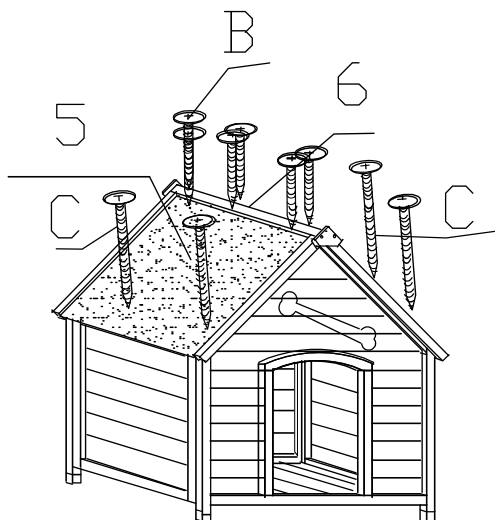

Notice: The entire roof can be separated from the main house from the top.

If you don't want the roof to be separated from the main house, there are 8pcs screw C, you can use them to secure the roofs with the front panel and back panel.

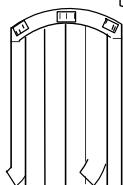

Notice: The door curtain is glued with Velcro, it is easy to disassemble and assemble.