

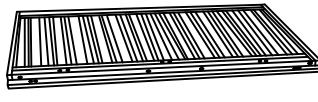

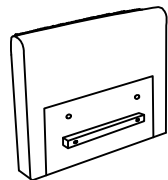

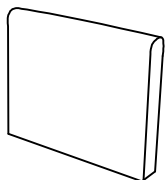

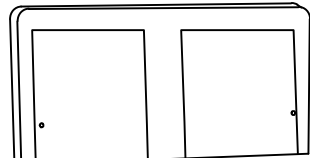

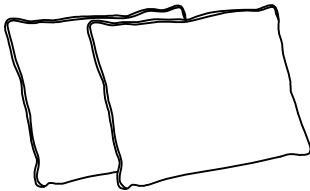
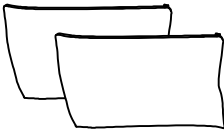
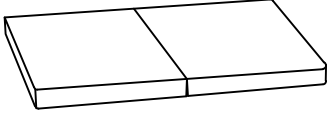
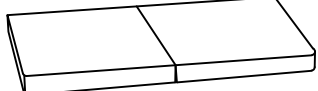
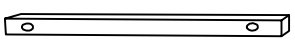
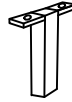
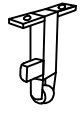
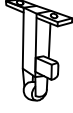
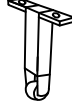
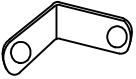
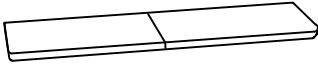

# ASSEMBLY INSTRUCTION

<b>A</b> Metal frame x1 	<b>B</b> Arm-L x1 	<b>C</b> Arm-R x1 	<b>D</b> Backrest x1 		
<b>E</b> Cushion x2 	<b>F</b> Arm Pillow x2 	<b>G</b> Seat cushion-L x1 	<b>H</b> Seat cushion-S x1 		
<b>I</b> Middle bar x1 	<b>J</b> Midfoot leg x1 	<b>K</b> Front leg x1 	<b>L</b> Front leg x1 	<b>N</b> Side leg x2 	<b>M</b> Angle iron x2 
<b>O</b> Front rail x1 	<b>1</b> Bolt x12 6x20 	<b>2</b> Washer x30 	<b>3</b> Allen wrench 8M 	<b>4</b> Bolt x4 8x40m 	<b>5</b> Allen wrench 6M 
<b>6</b> Bolt x4 8x30 	<b>8</b> Bolt x6 8x60 	<b>9</b> Bolt x4 8x25 	<b>10</b> Leg x4 		



STEP1:

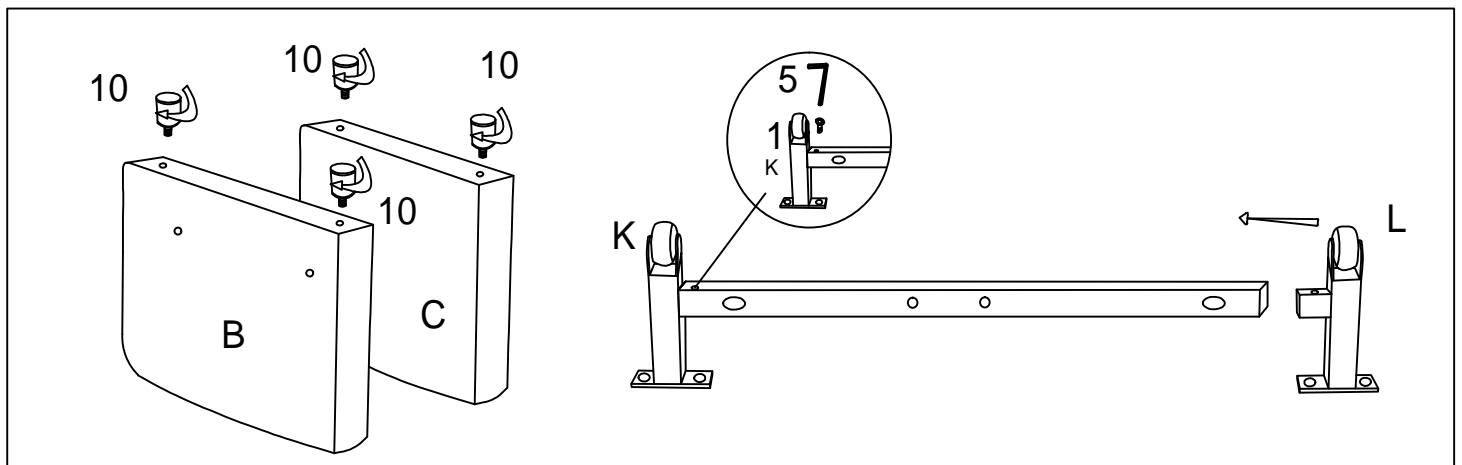
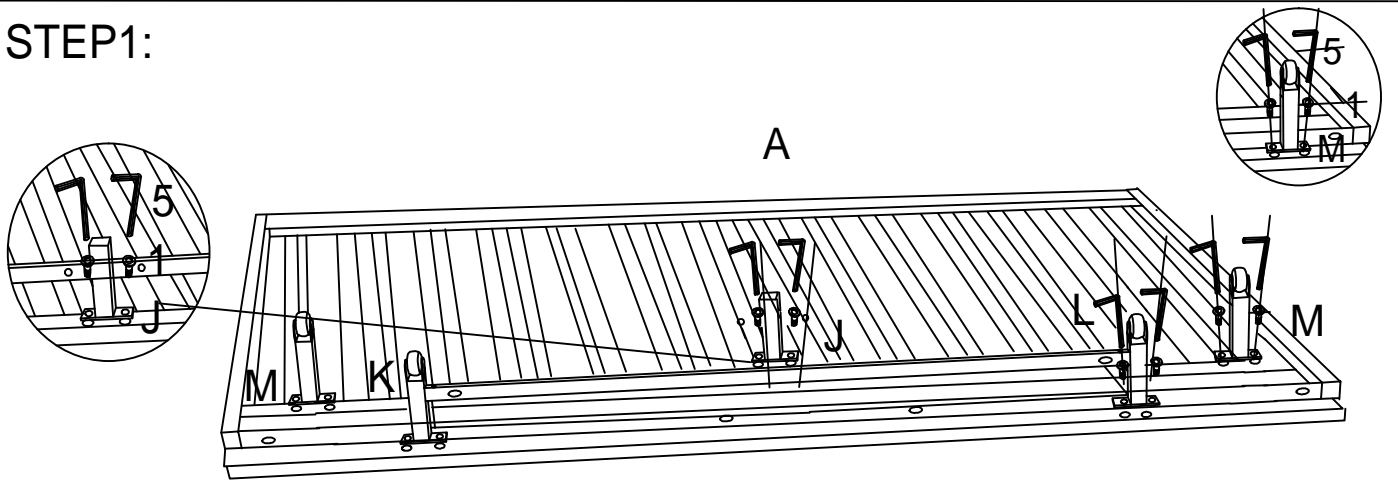

STEP2:

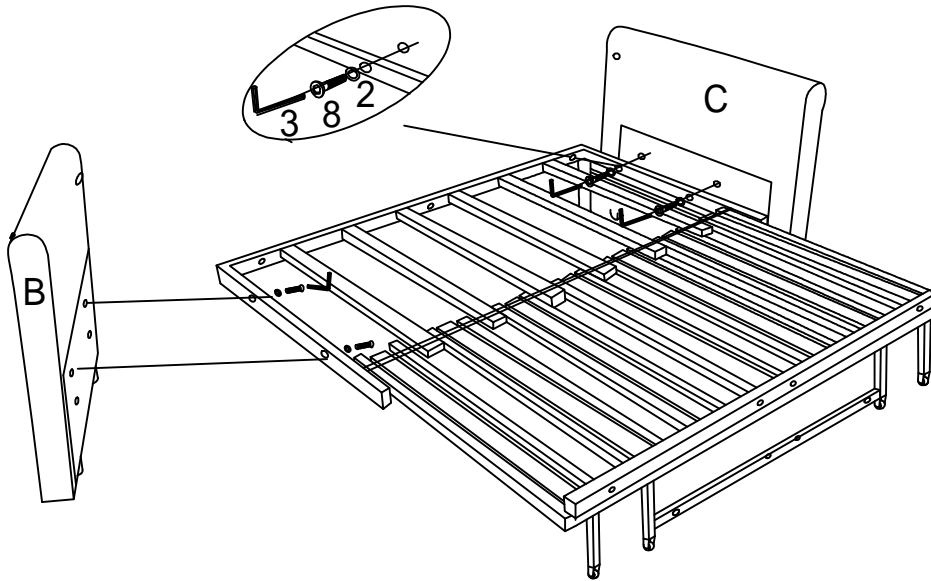

STEP3:

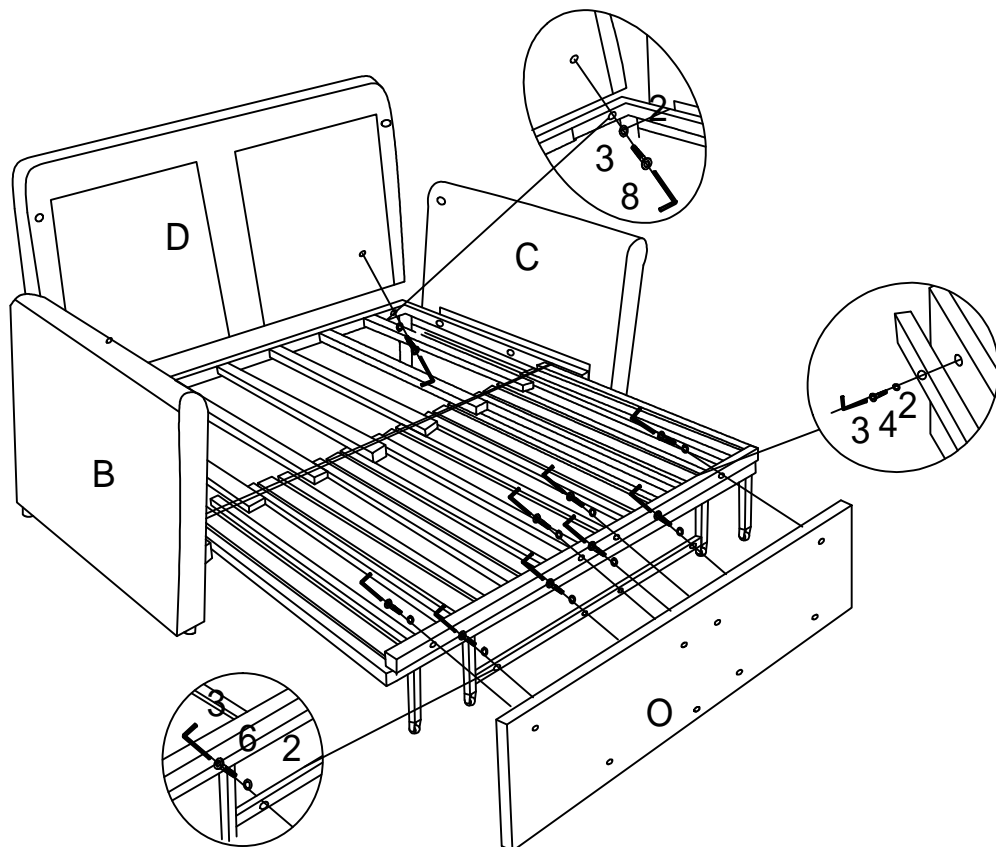

STEP4:

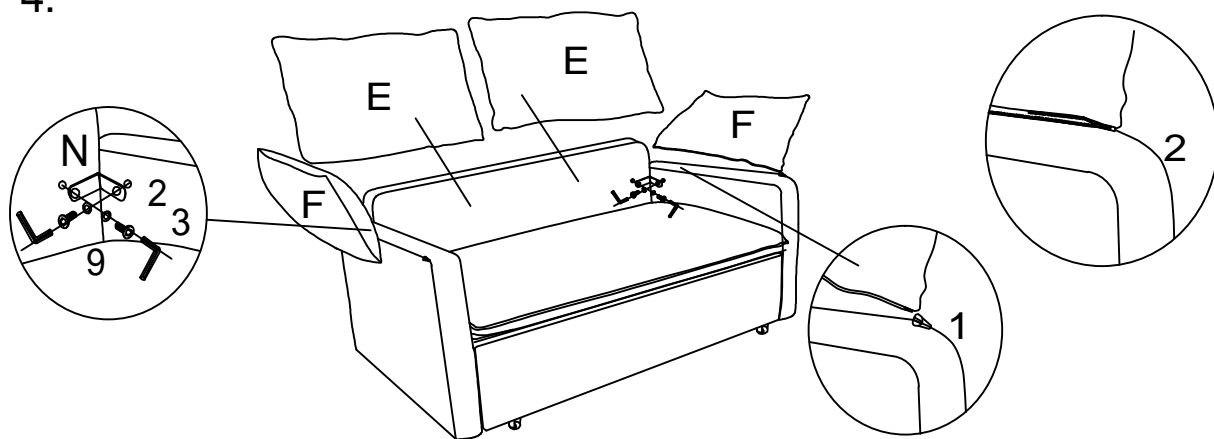

STEP5:

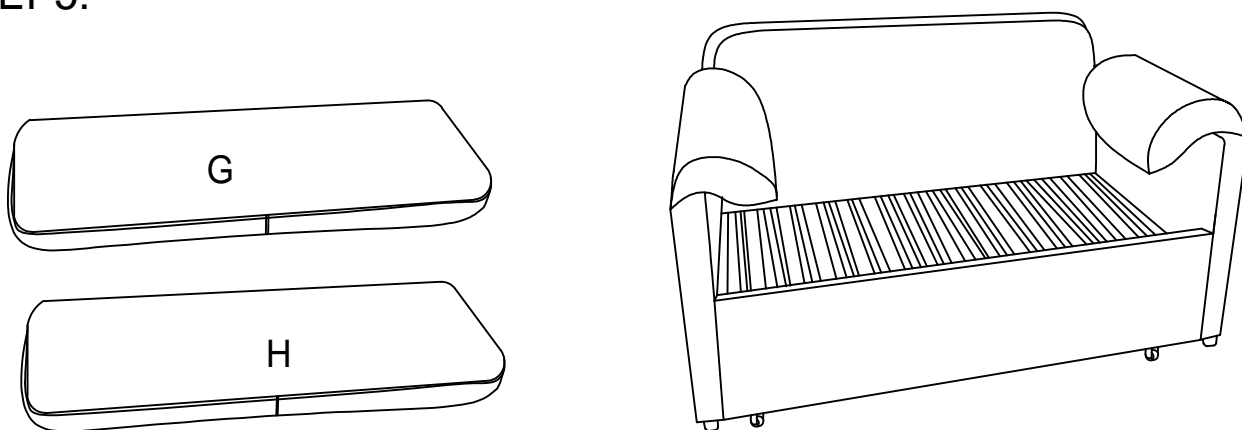

STEP6:

