

20'

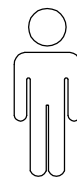

1

1/4

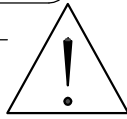
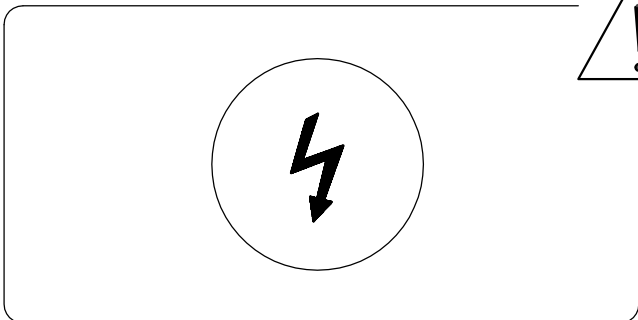
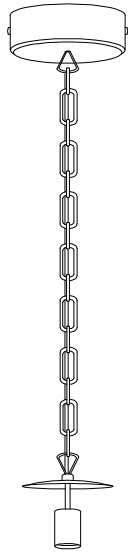
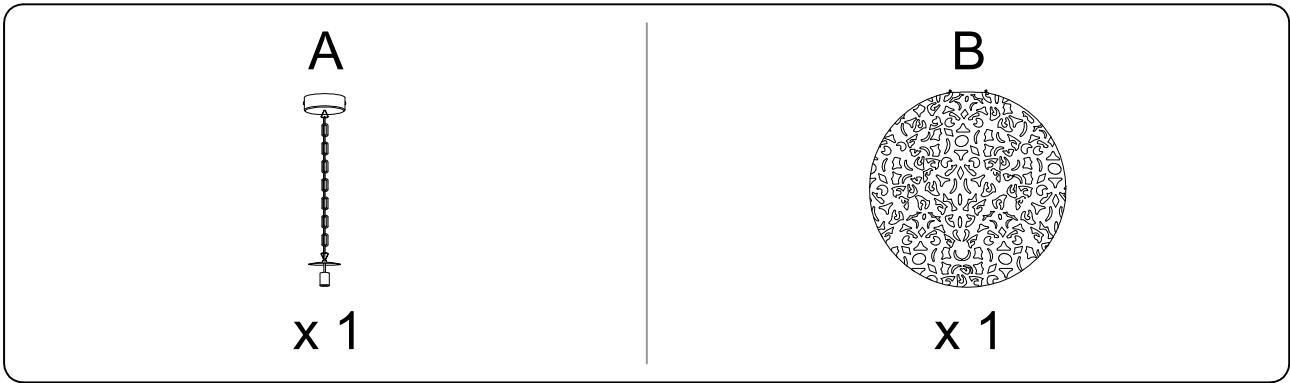

**A**

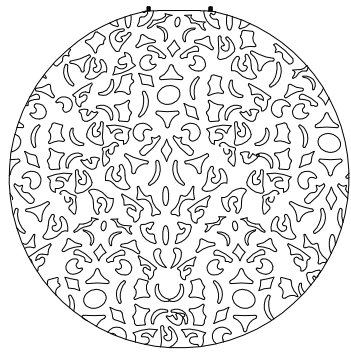

**B**

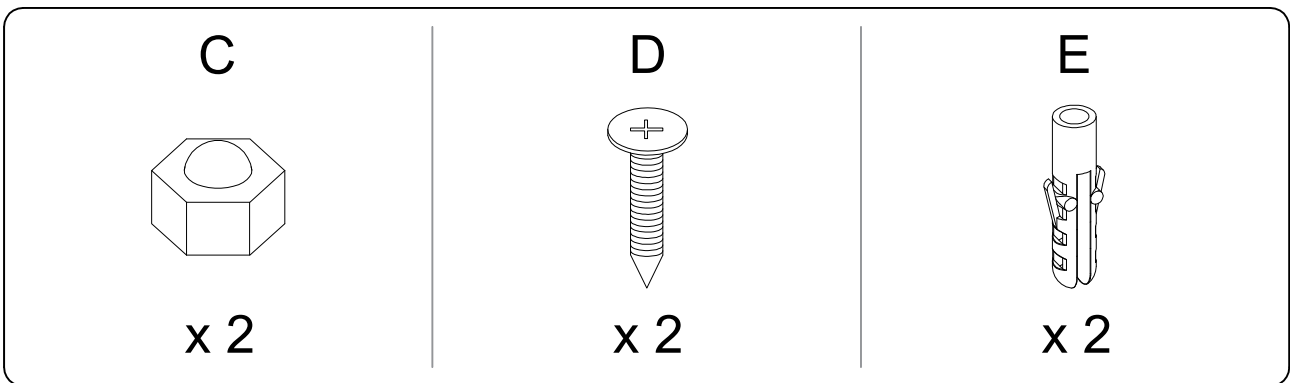

1

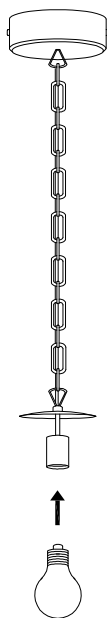
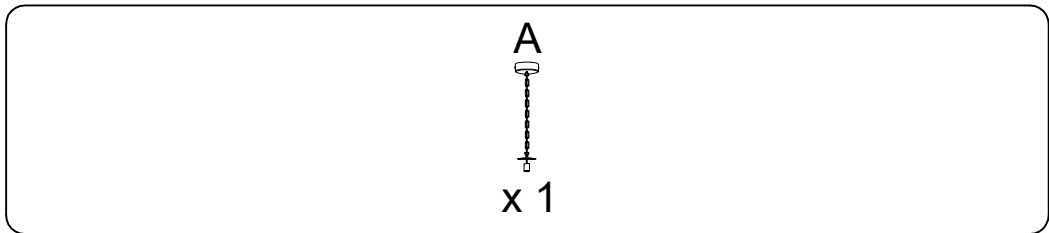

2

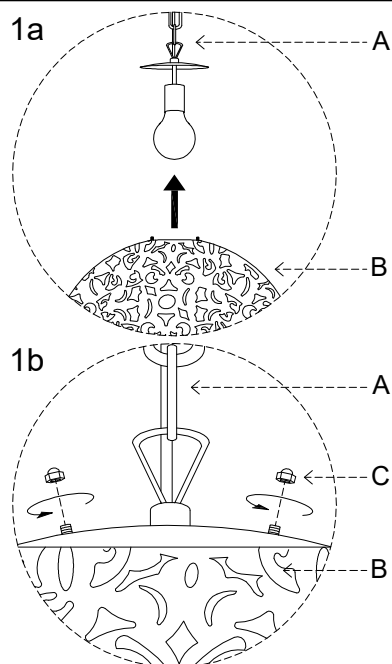
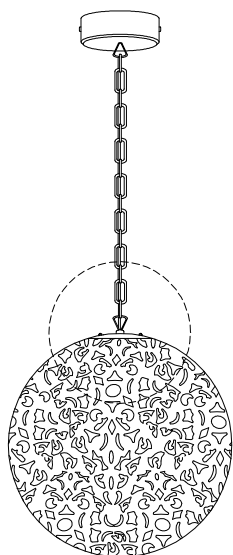
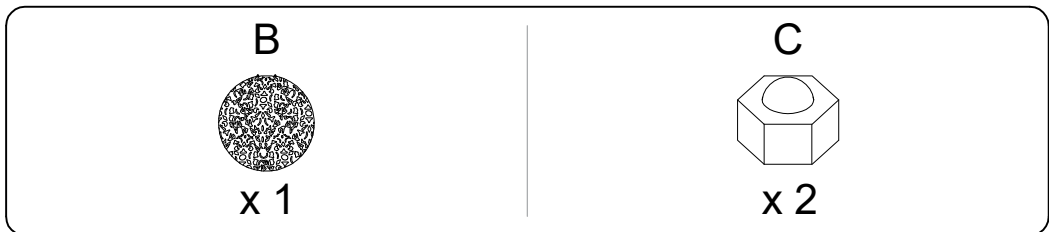

3

D

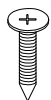

x 2

E



x 2

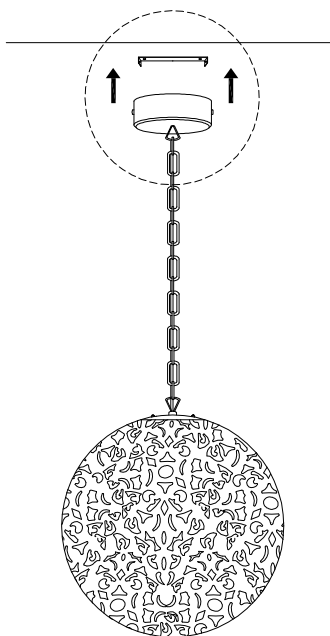

1a

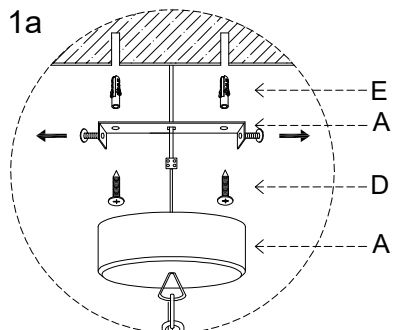

1b

