





ASSEMBLY INSTRUCTION

Thank you for purchasing our sofa.

Before you start, here is some helpful advice:

1. We suggest you spend a short time reading through the instructions before assembling .
 2. Owing to the size and weight of the sofa, we recommend that it is assembled by two adults. Approximate assembly time is 20 minutes.
 3. Please do not throw away any of the packages or the instructions until the sofa is fully assembled. Please ensure that the packages are disposed in a safe place.
 4. Assemble all components loosely until advised to tighten. Depending on use, it may be necessary to tighten the components from time to time.
 5. Please keep all pieces out of reach of children.
 6. If you have any questions about the product, please send an email to our customer service email. We will reply to your questions within 12 hours.
-

Components:

NO.	Picture	Description	Sofa
A		Plastic Washer	6pcs
B	 H=3.5cm	Leg	6pcs
C		Backrest	1XL 1XR
D		Sofa Body	1pc
E		Cushion	2pcs

STEP 1:

We packed the sofa in one cartons,one for Sofa(1),carton NO:1/1.



Sofa

ASSEMBLY INSTRUCTION

STEP 2 :

- 1.Lay the carton of sofa flat on the floor.
- 2.Please open the carton of the sofa.
- 3.Take out a box of AB from the bottom of the sofa Storage and 2 C Backrests from the Sofa Storage.
Two Cushions From The Package.

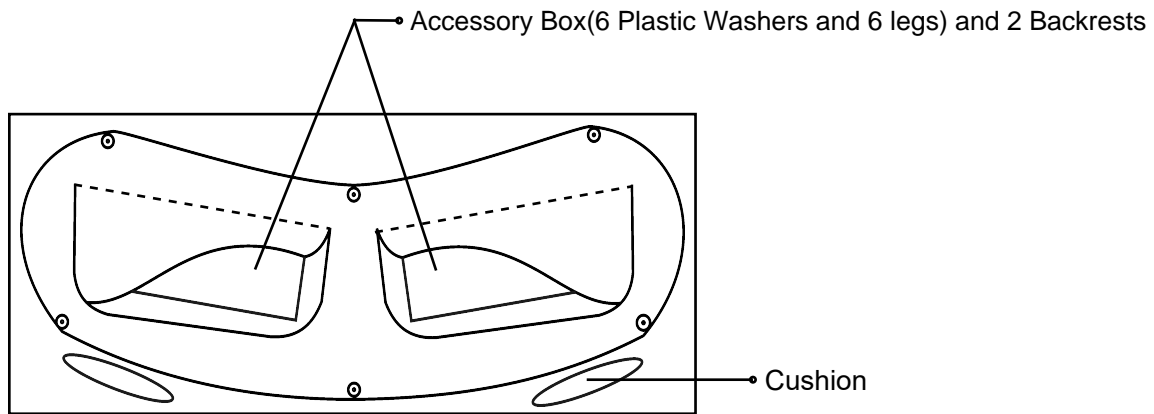

STEP 3 :

- 1.Place the washers(A) and legs(B) on the F point.And rotate them until tightened.
- 2.Insert the backrests(C) into the back of the sofa body(D).

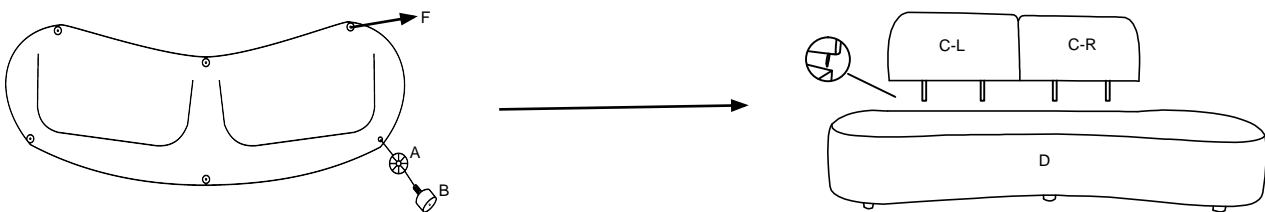

STEP 4:

- 1.Finally put the Cushion on the sofa.

