

		20'
		2

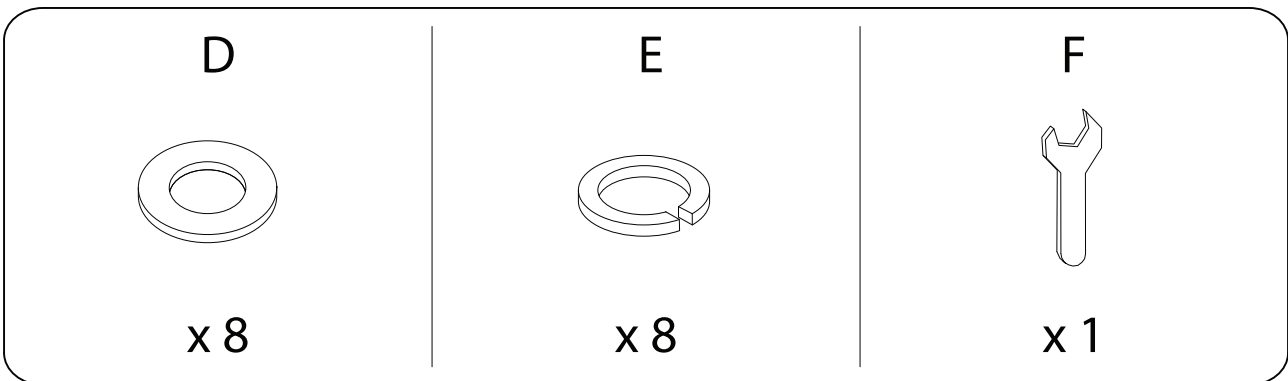

!

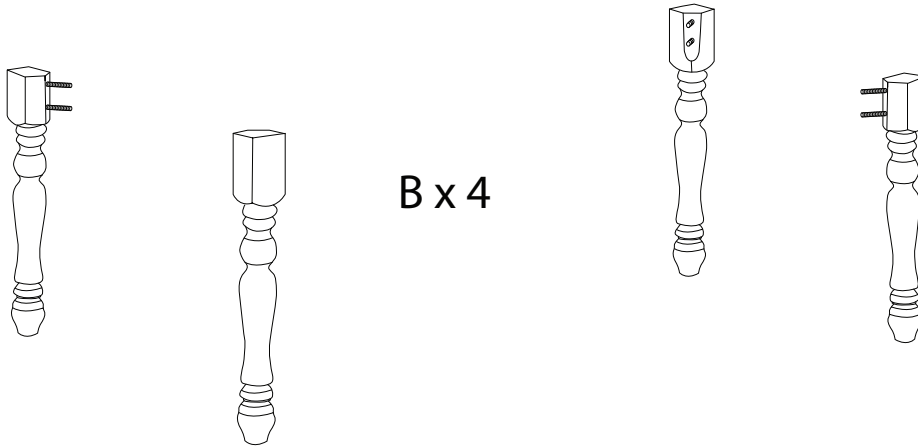
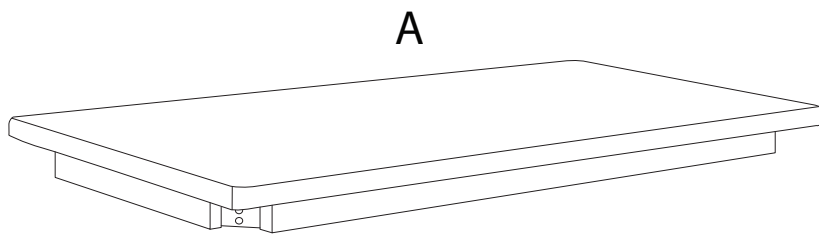
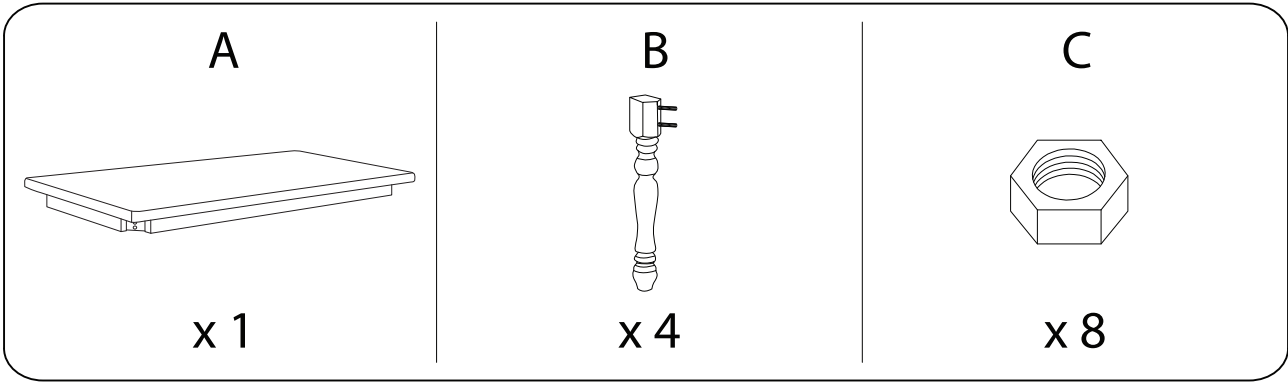
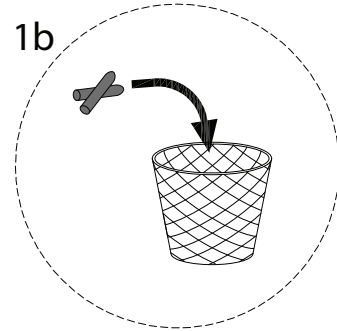
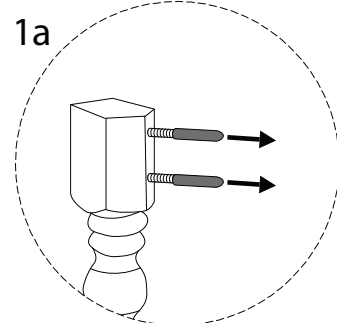
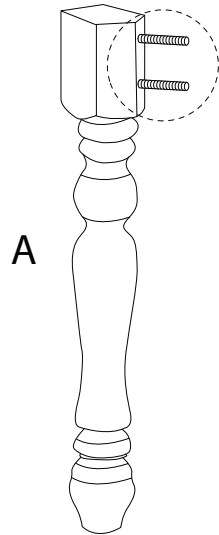

1

A x 1	B x 4	C x 8	D x 8	E x 8	F x 1
---------------------	---------------------	---------------------	---------------------	---------------------	---------------------

