

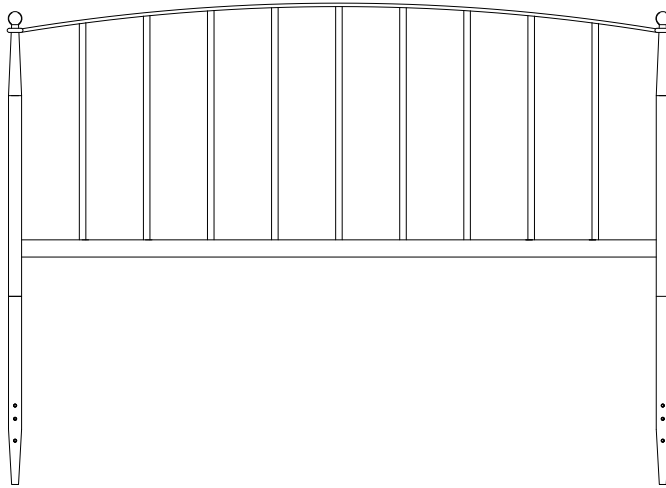

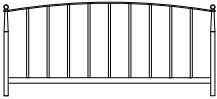

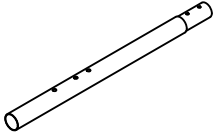

King Metal Headboard

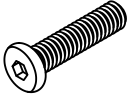

PART LIST

<p>A</p> 	<p>B</p> 
<p>Headboard Panel 1 PC</p>	<p>Leg Extension 2 PCS</p>

HARDWARE LIST

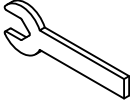
<p>#1</p>  <p>1/4" x 1/2"L</p>	<p>#2</p>  <p>1/4" x 2-1/4"L</p>	<p>#3</p>  <p>1/4"</p>	<p>#4</p>  <p>Ø16xØ6.5x1MM</p>	<p>#5</p> 
<p>Bolt 4 PCS (Extra 1)</p>	<p>Long Bolt 4 PCS (Extra 1)</p>	<p>Hex Nut 4 PCS (Extra 1)</p>	<p>Flat Washer 8 PCS (Extra 1)</p>	<p>Allen Wrench 1 PC</p>
<p>#6</p> 				
<p>Wrench 1 PC</p>				

Step 1. Lay headboard panel (part A) upside down on a soft flat surface, such as carpet, as shown below. Attach leg extensions (part B) to headboard panel (part A) using bolts (part #1), flat washers (part #4) and allen wrench (part #5).

NOTE: Please do not fully tighten bolts until unit is fully assembled.

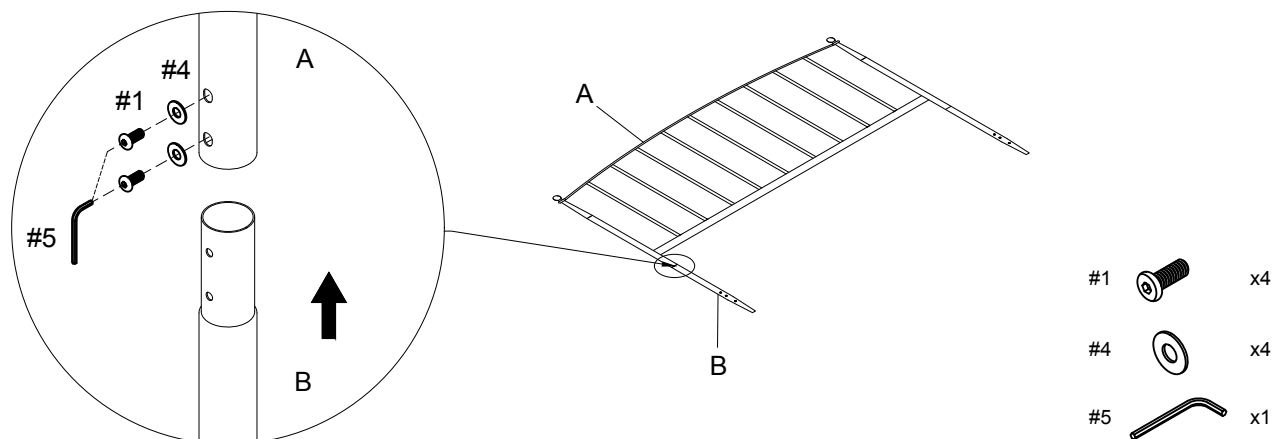

Step 2. Attach bed frame (*Not Included) to leg extensions (part B) using long bolts (part #2), flat washers (part #4), hex nuts (part #3), allen wrench (part #5) and wrench (part #6).

NOTE: Please fully tighten all bolts at this time.

