

**ASSEMBLY GUIDE
GUIDE DE MONTAGE
GUÍA DE MONTAJE**

CLASSIC

**CLASSIQUE
CLÁSICO**

CAMBRIDGE PLANTER

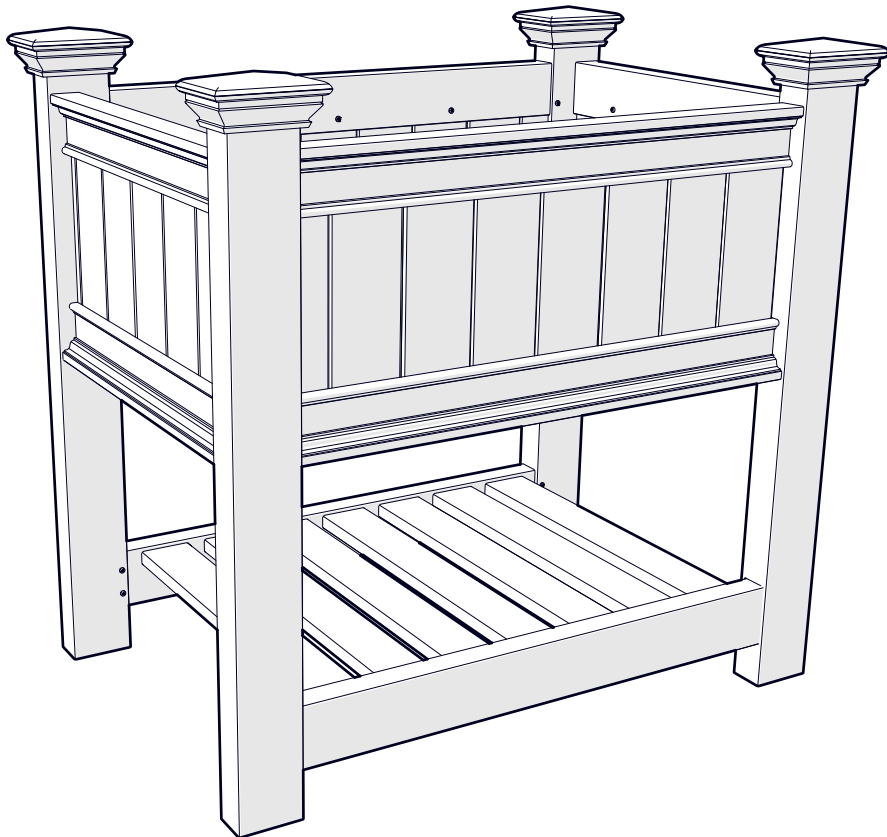

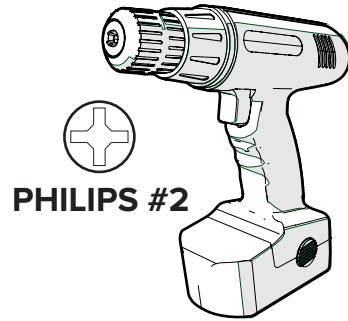
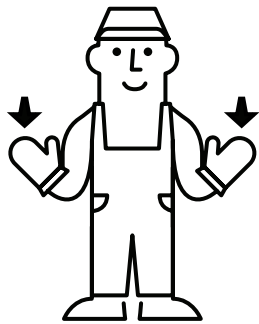
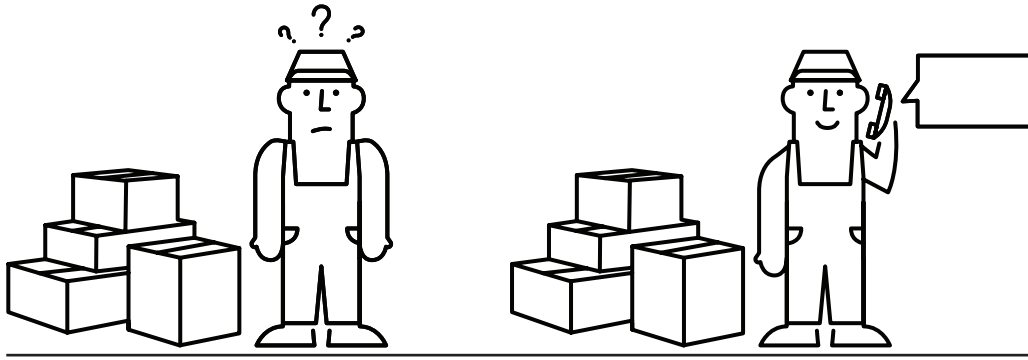

PHILIPS #2

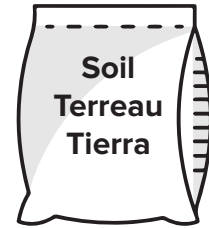

120 L (Liters)
or
4 Ft³ (Cubic Feet)

REQUIRED TOOLS AND MATERIALS (NOT INCLUDED)
OUTILS ET MATÉRIAUX REQUIS (NON INCLUS)
HERRAMIENTAS Y MATERIALES REQUERIDOS (NO INCLUIDOS)

PRODUCT DIMENSIONS DU PRODUIT DIMENIONES DEL PRODUCTO

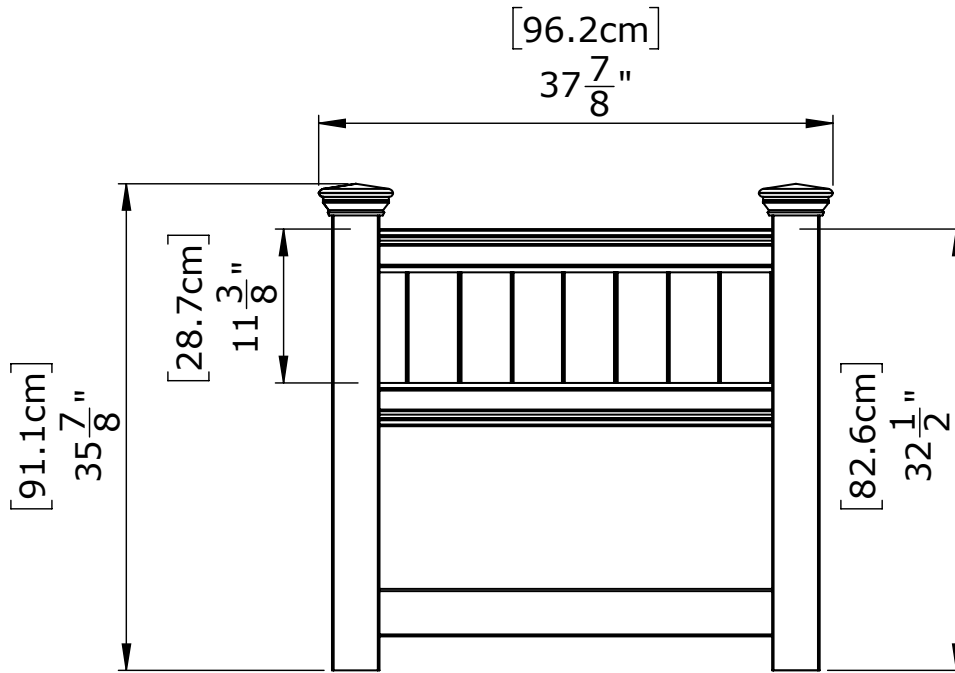

Front View

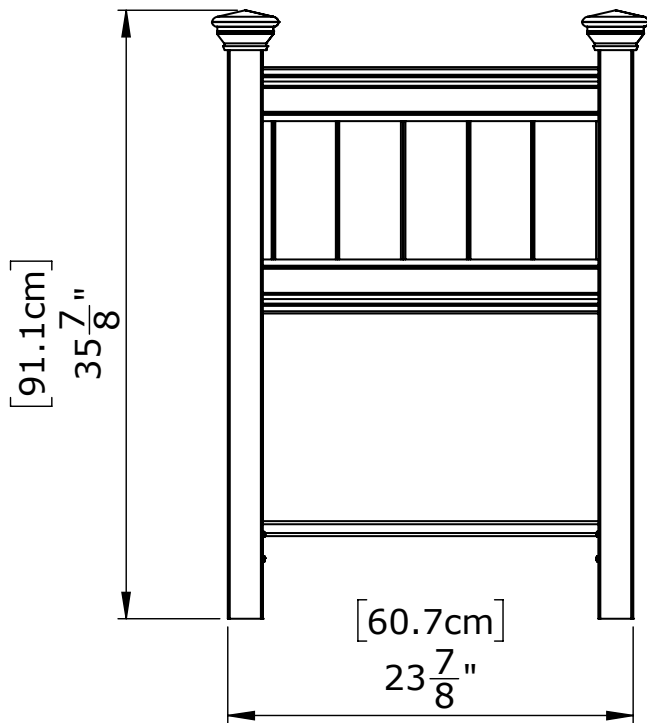

Side View

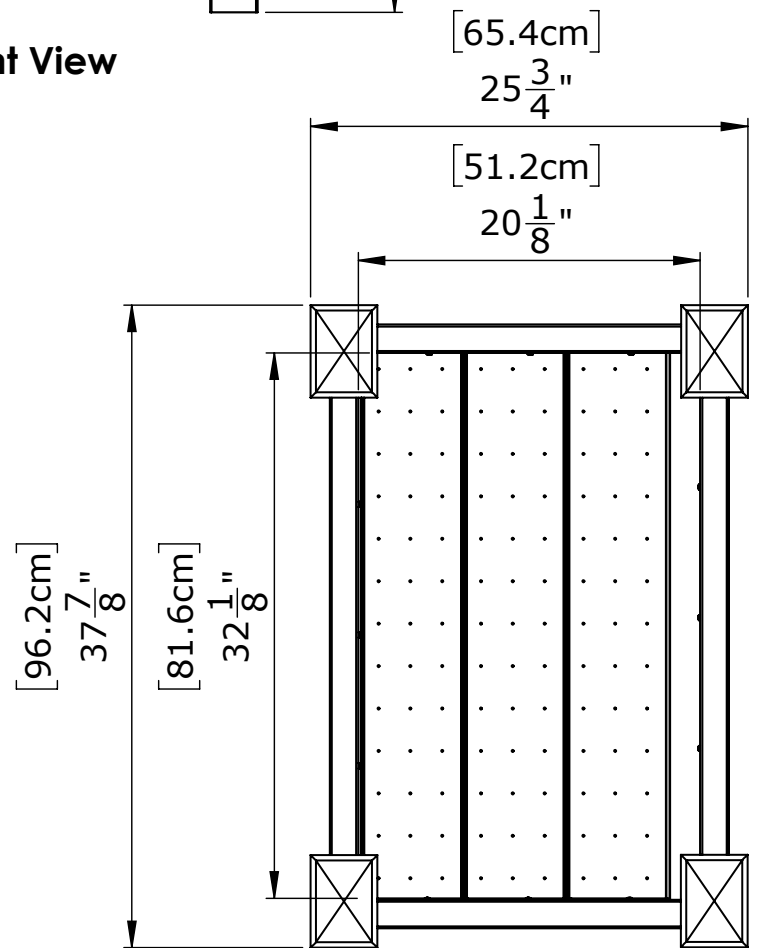

Top View

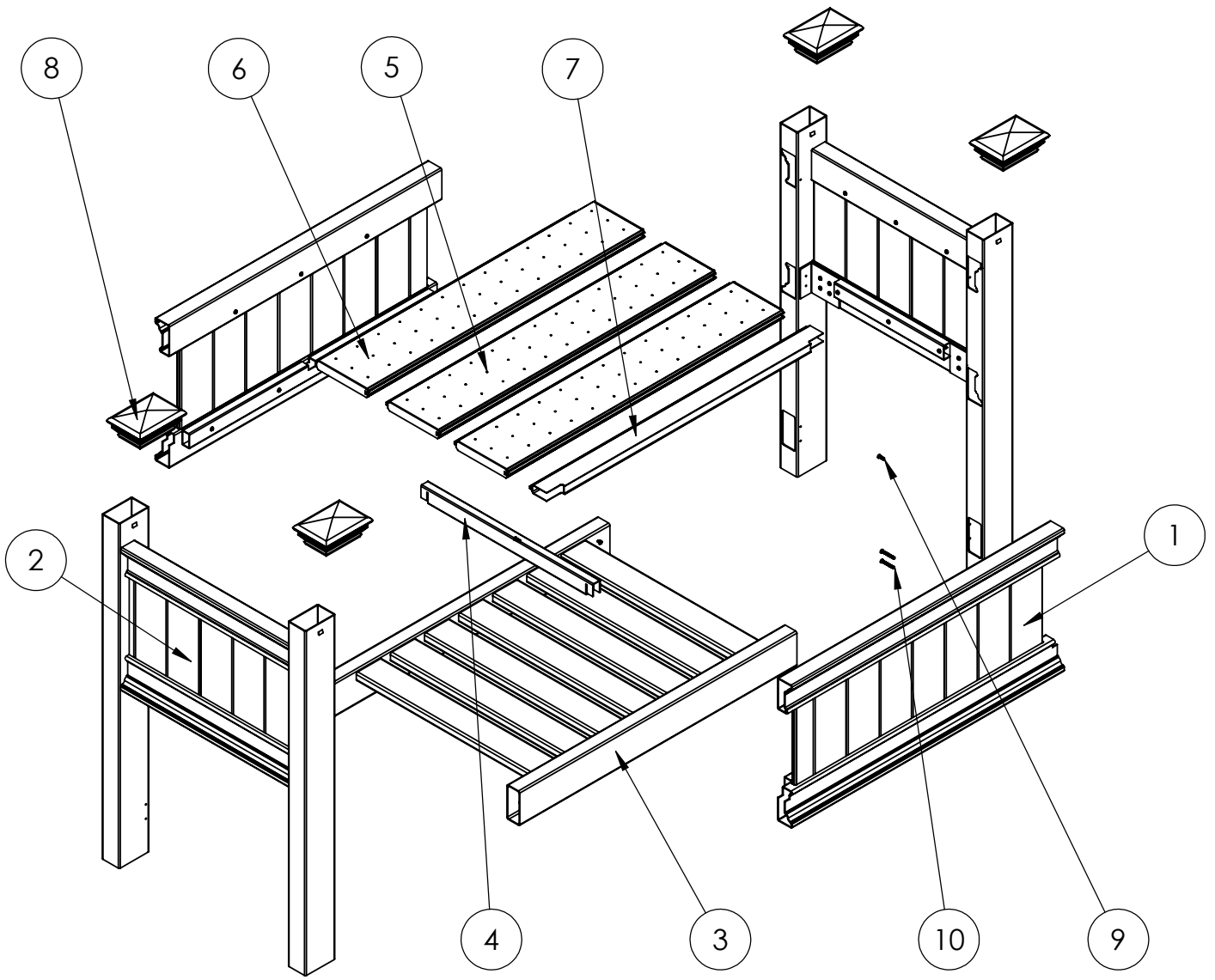

ITEM NO.	DESCRIPTION	QTY.
1	FRONT & BACK WALL PANEL	2
2	SIDE WALL PANEL	2
3	PRE-ASSEMBLED SHELF	1
4	SHELF SUPPORT	1
5	MIDDLE FLOOR BOARD	2
6	SIDE FLOOR BOARD	1
7	FLOOR BOARD WITH CUTOUT	1
8	POST CAP	4
9	5/8" (1.6CM) STAINLESS STEEL SCREW	12
10	1 1/2" (4CM) STAINLESS STEEL SCREW	8

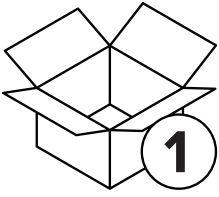

PARTS LIST

LISTE DES PIÈCES
LISTADO DE PIEZAS

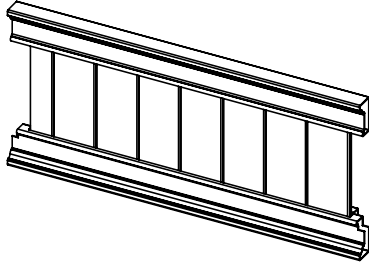
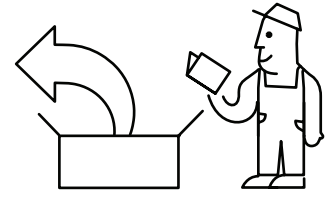

1

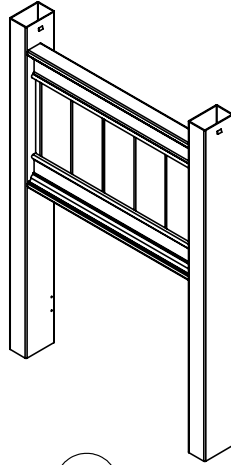

2

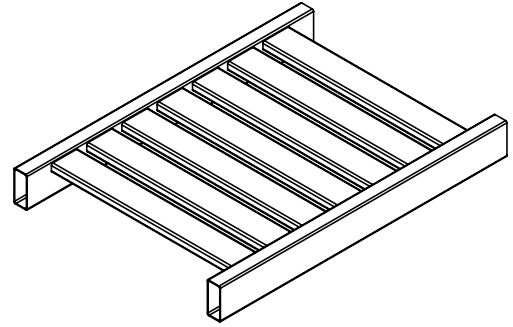

3

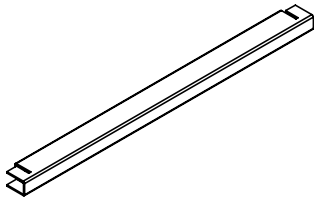

4

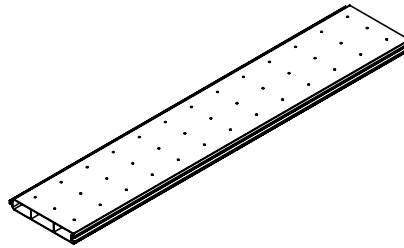

5

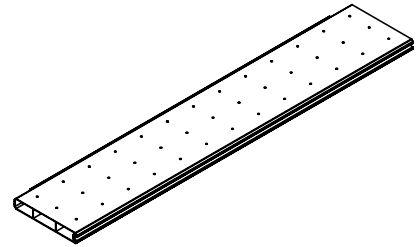

6

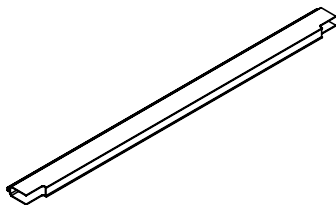

7

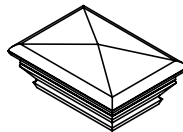

8



9



10

INSTALL THE FRONT AND BACK WALL PANEL, AND THE PRE-ASSEMBLED SHELF

INSTALLEZ LA PAROI DE DEVANT ET DE DERRIÈRE, ET L'ÉTAGÈRE PRÉ-ASSEMBLÉE
MONTE LAS PAREDES DELANTERA Y TRASERA CON LA PLATAFORMA PREARMADA

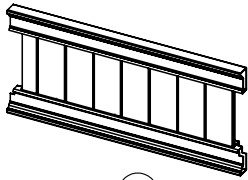

①
2X

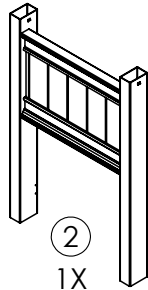

②
1X

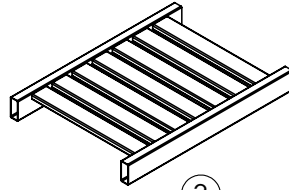

③
1X

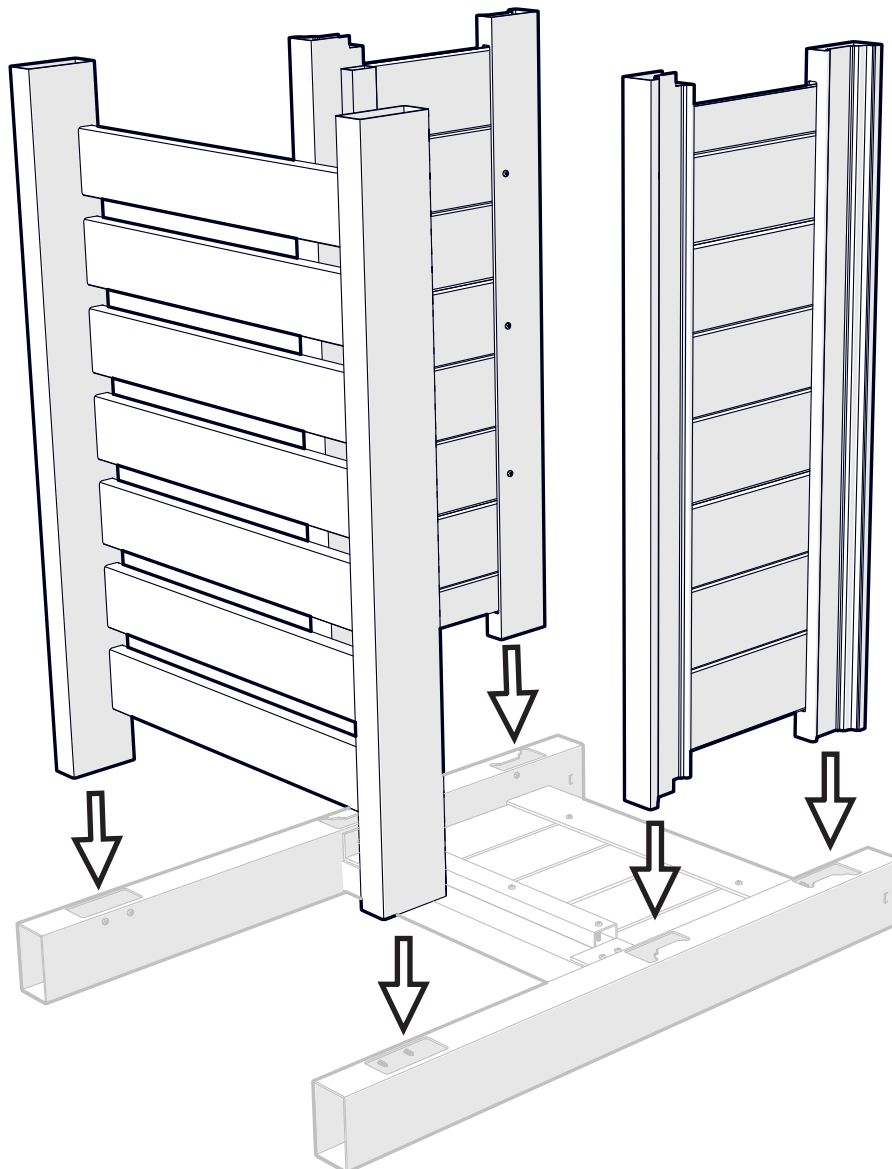
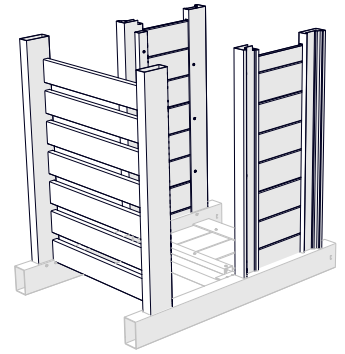

AT THIS POINT IF YOU PURCHASED THE EXTENTION KIT, PLEASE GO TO STEP 2 ON THE INSTRUCTION MANUAL FOR “THE CAMBRIDGE RAISED PLANTER EXTENTION KIT”.

IF YOU DID NOT PURCHASE THE EXTENTION KIT, PLEASE CONTINUE TO STEP 2 ON THE NEXT PAGE OF THESE INSTRUCTIONS.

À CE STADE SI VOUS AVEZ ACHETÉ LE KIT D’EXTENSION, ALLEZ A L’ÉTAPE 2 DANS LE MANUEL D’INSTRUCTION POUR LE KIT D’EXTENSION DE L’ESPACE DE PLANTATION SURÉLEVÉ CAMBRIDGE.

SI VOUS N’AVEZ PAS ACHETÉ LE KIT D’EXTENSION, CONTINUEZ A L’ÉTAPE 2 SUR LA PAGE SUIVANTE DE CES INSTRUCTIONS.

SI COMPRÓ EL KIT DE EXTENSIÓN, SIGA CON EL PASO 2 DEL MANUAL DE INSTRUCCIONES DEL «KIT DE EXTENSIÓN PARA EL ARRIATE ELEVADO CAMBRIDGE».

SI NO COMPRÓ EL KIT DE EXTENSIÓN, CONTINÚE CON EL PASO 2 DE LA SIGUIENTE PÁGINA DE ESTAS INSTRUCCIONES.

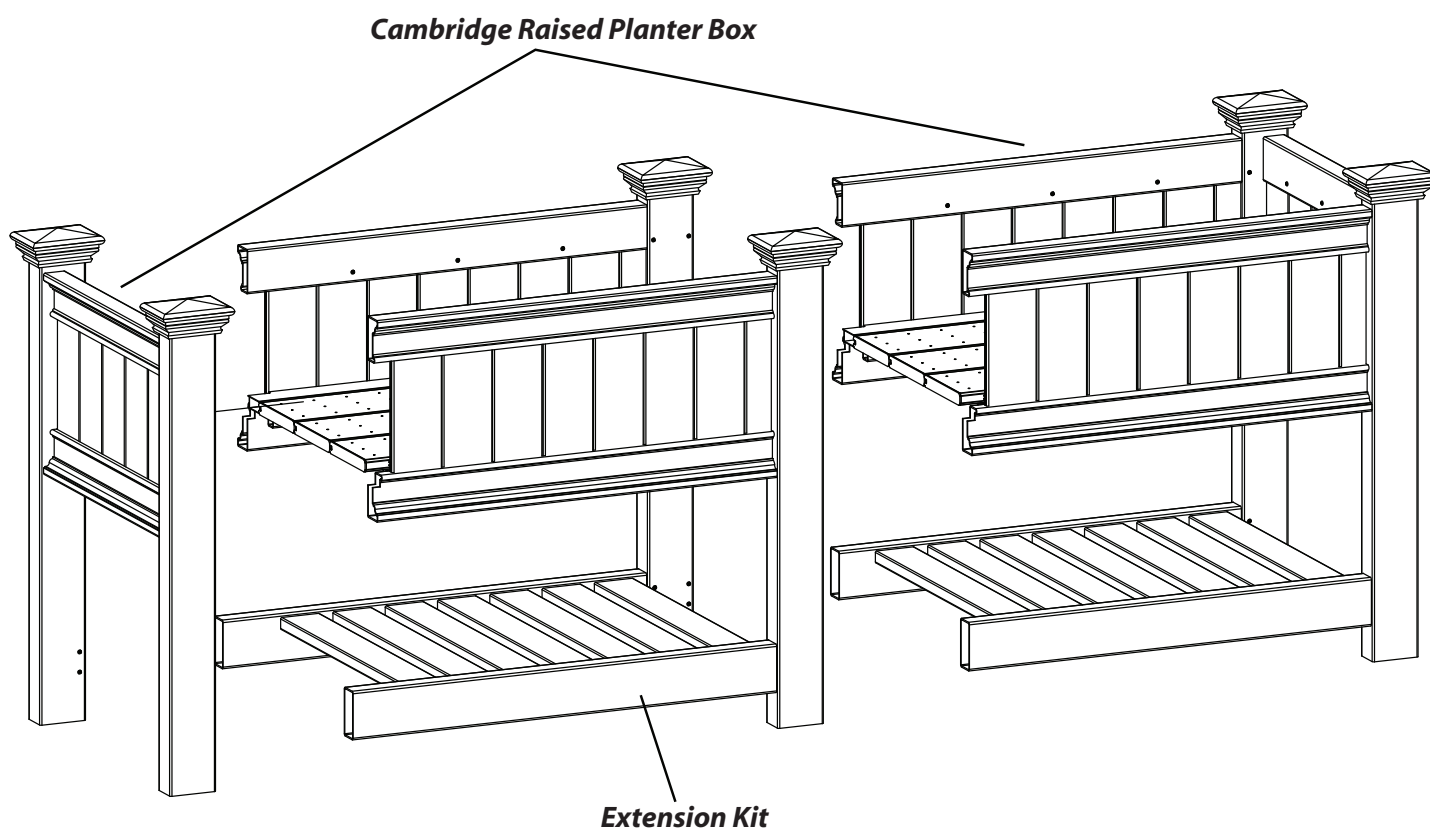

2 ATTACH THE SIDE WALL PANEL

ATTACHEZ LE PANNEAU DE LA PAROI LATÉRALE

MONTE LA PARED LATERAL

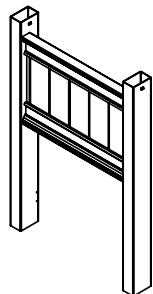

2

1X

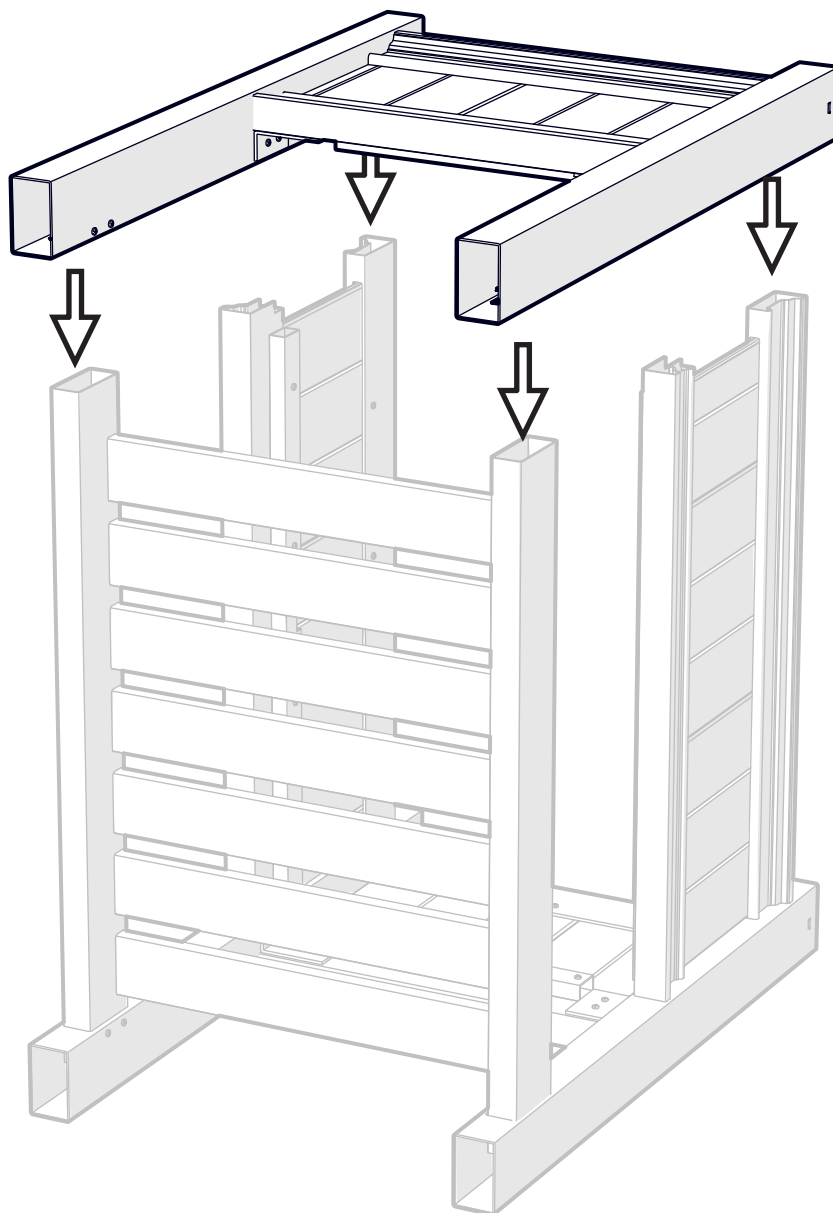
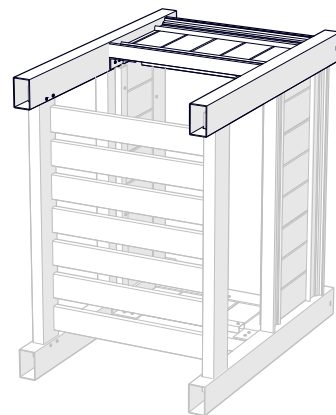

3 SECURE THE PRE-ASSEMBLED SHELF

FIXEZ L'ÉTAGÈRE PRÉ-ASSEMBLÉE
ASEGURE LA PLATAFORMA PREARMADA

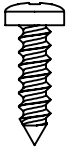

9
8X

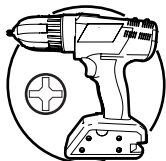
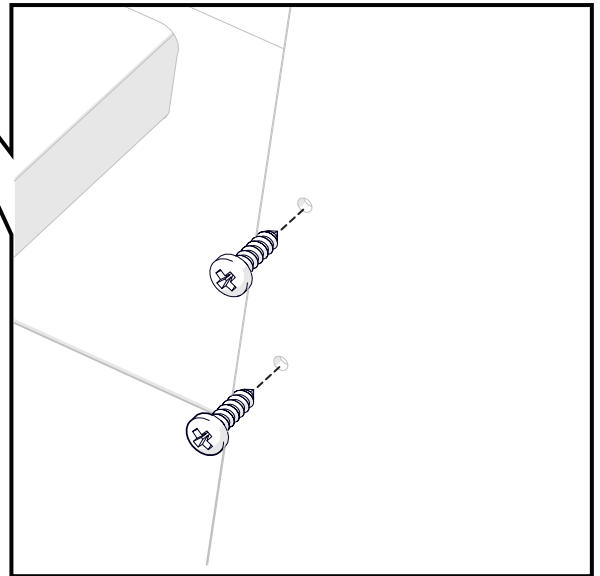
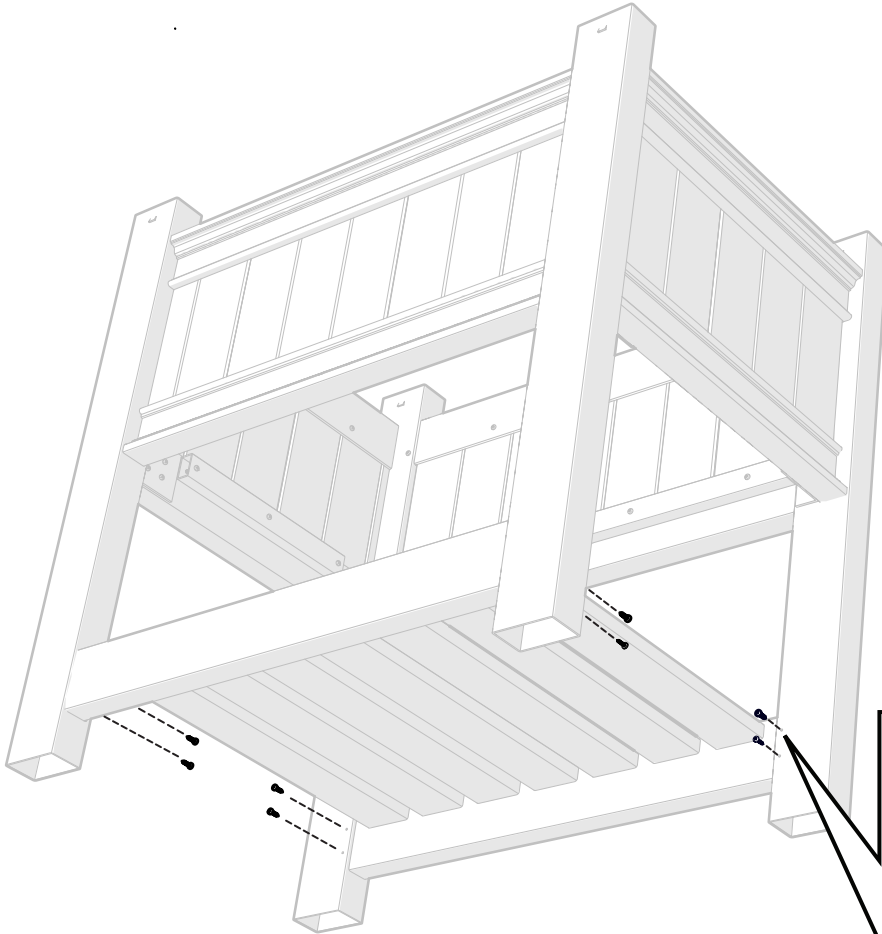
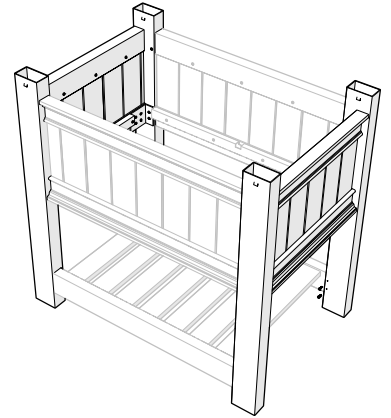

PHILIPS #2

4 FASTEN THE SIDEWALL PANELS

ATTACHEZ LE PANNEAU LATÉRAL
FIJE LOS PANELES LATERALES

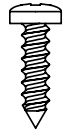

9
4X

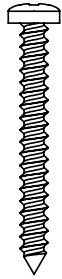

10
8X

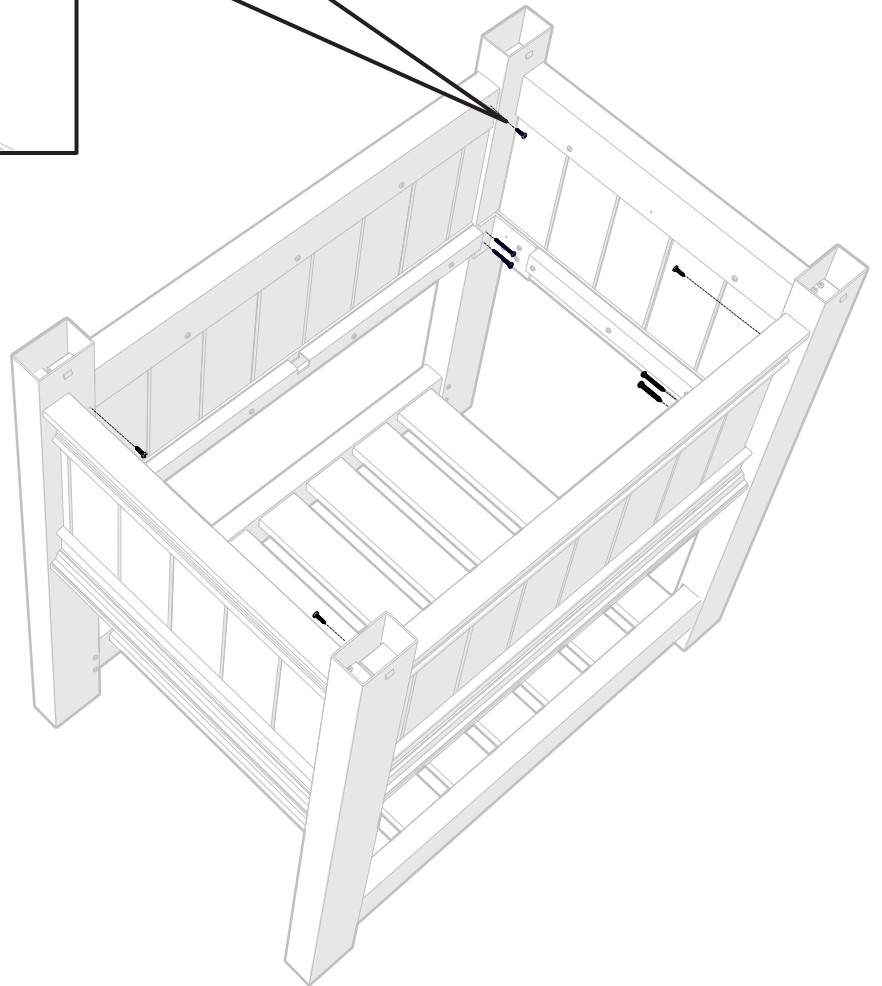
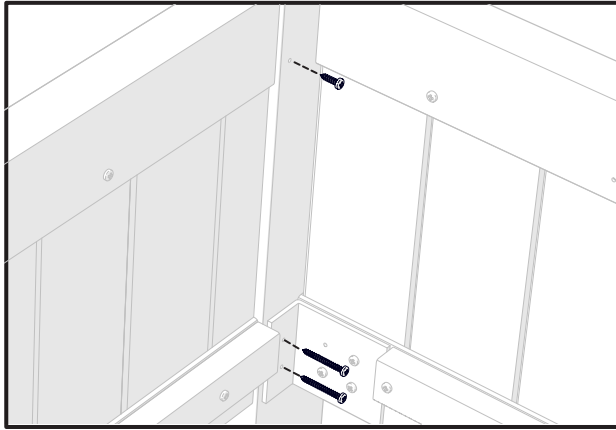
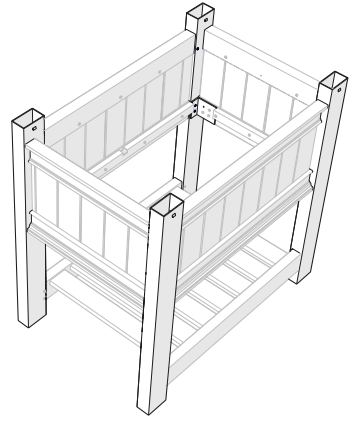

10

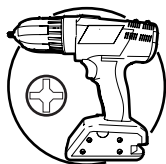

PHILIPS #2

5 SLIDE DOWN THE FLOOR SUPPORT

FAITES GLISSER LE SUPPORT DE PLANCHER
DESCLICE HACIA ABAJO EL SOPORTE DEL SUELO

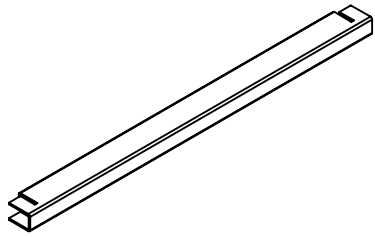

4
1X

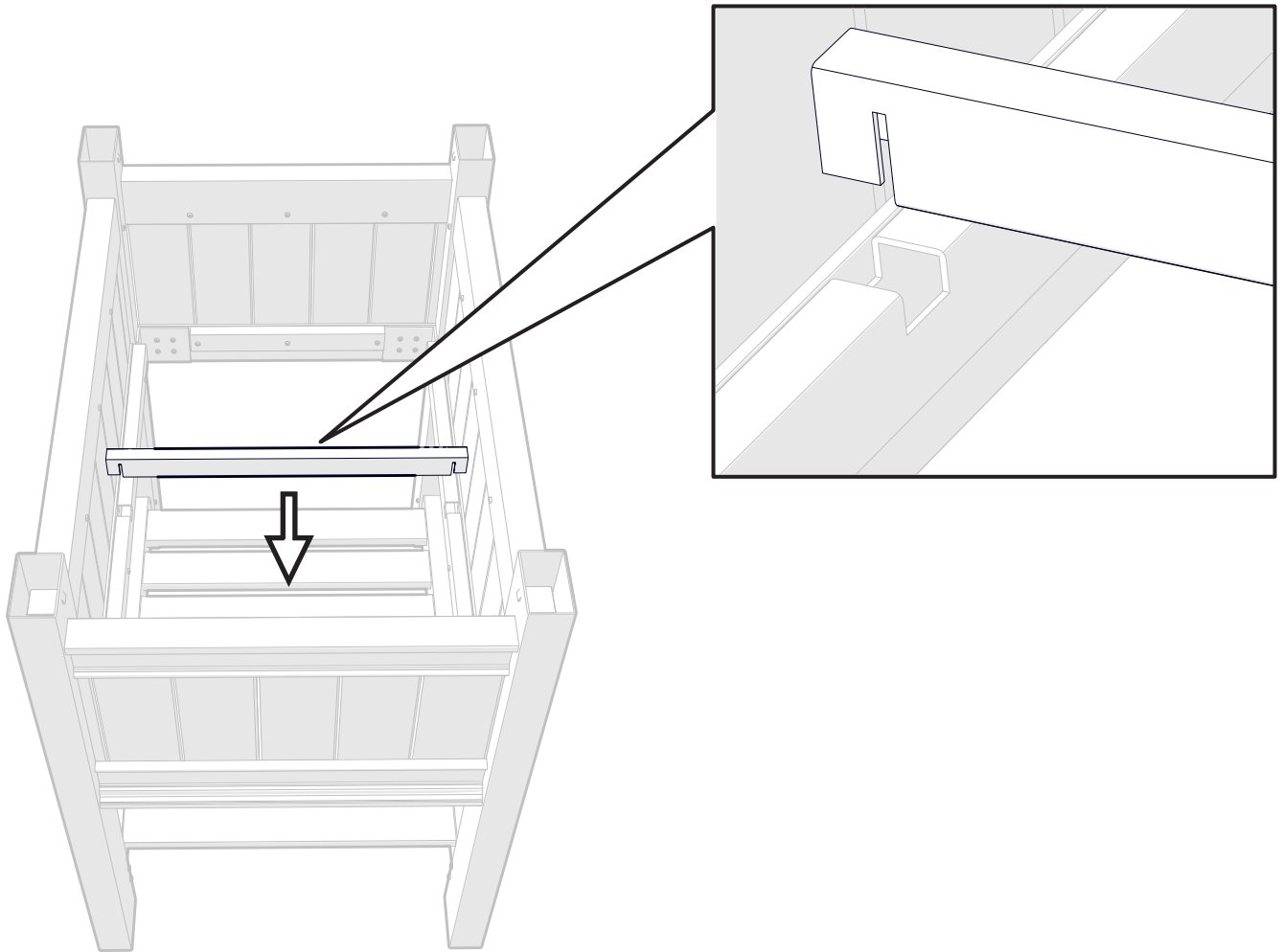
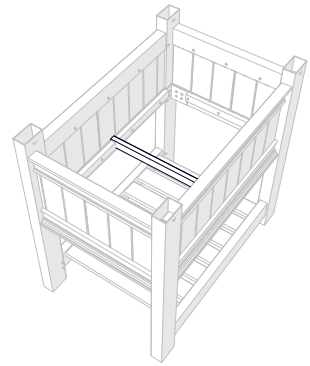

6 ATTACH THE FLOOR BOARDS

ATTACHEZ LES PLANCHES DU FONDS

COLOQUE LAS TABLAS DEL SUELO

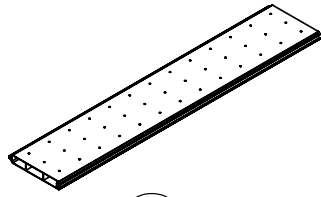

5
2X

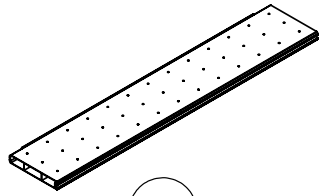

6
1X

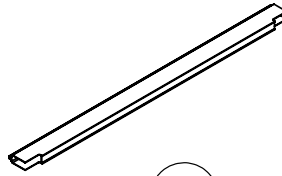

7
1X

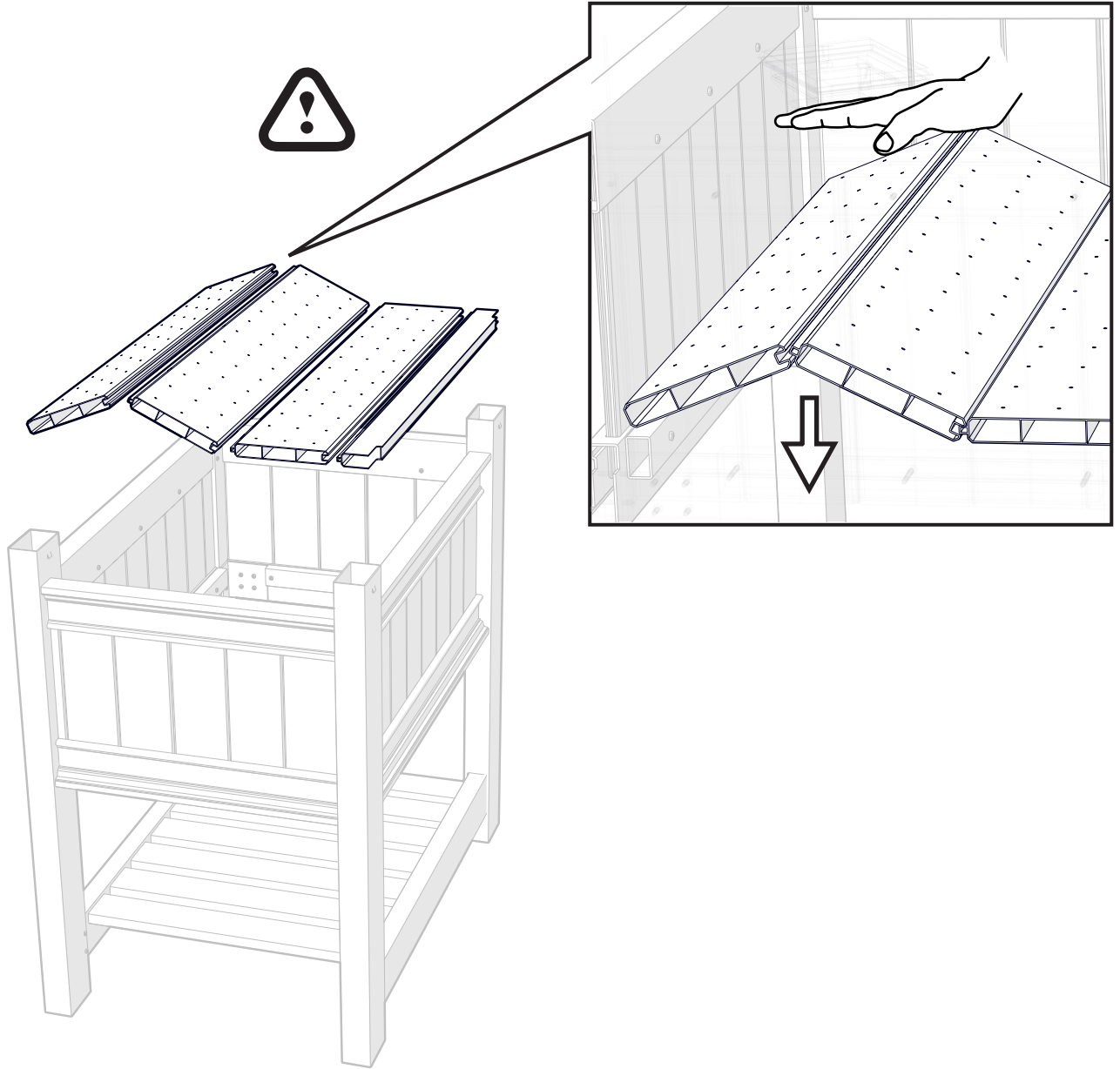
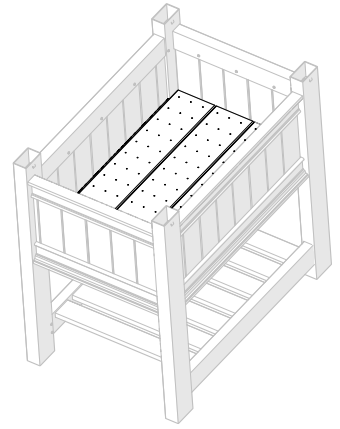

7 SECURE THE POST CAPS

FIXEZ LES EMBOUTS DE POTEAUX
COLOQUE LOS TOPES EN LOS POSTES

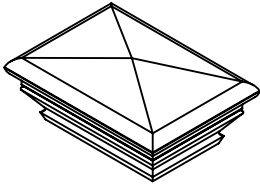

8
4X

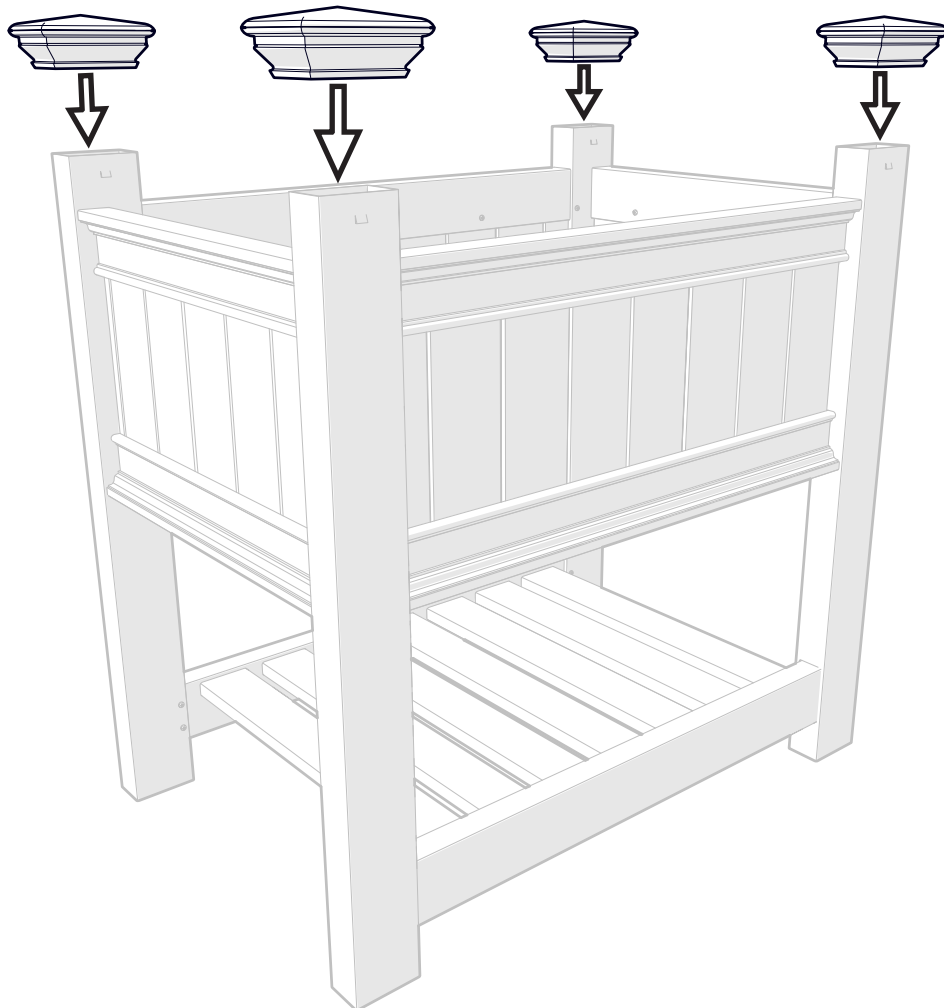
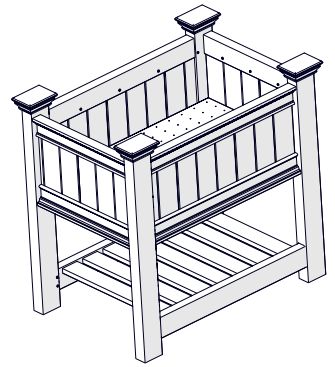

COMPLETED KIT

VUE DU KIT TERMINÉ
PRODUCTO ARMADO

