

Owner Manual

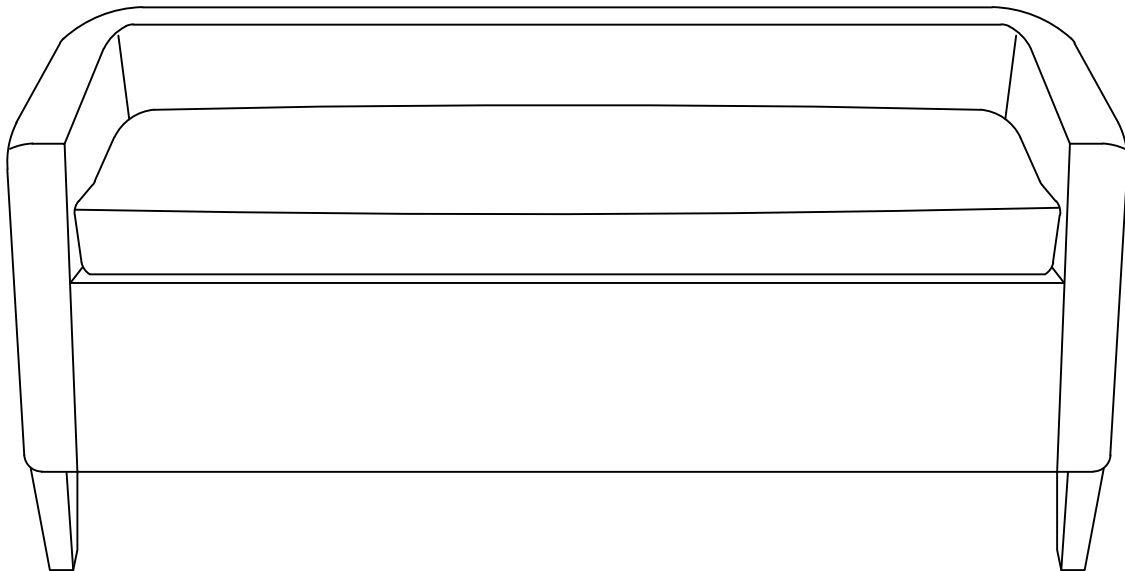

Per Seat Weight Limitation

700 LBS



Installation:
10 minutes.

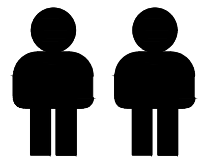

Two Person

NOTE:





This brochure contains **IMPORTANT** safety info. Please read and keep it for future reference.

MAINTENANCE AND WARNINGS



Before You Start

Please follow the steps below:

-  Check the packaging for any damage, deformation, or water stains. If there is significant damage, please contact us promptly.
-  Unpack the box and compare the contents with the parts list and hardware list to ensure all components and accessories are present and complete.
-  Please read the installation instructions carefully to understand the installation steps and precautions to ensure proper installation.
-  Clean the installation area in advance and ensure the ground is level and there is enough space to avoid damaging the furniture or making installation difficult.
-  Lay a protective mat on the ground to prevent scratching the floor during installation.

After-Sales Service

- If you encounter any issues or need technical support during use, please contact our after-sales team. We offer long-term maintenance and warranty services.



Precautions

- ⚠ This product is for indoor use only. Do not expose it to outdoor elements or high-humidity environments.
- ⚠ Keep the product away from high heat or open flames to prevent fire hazards.
- ⚠ Do not allow children to climb on the product, as this may cause tipping and result in personal injury.



Safety Warnings

- ⚠ If you notice any loose or damaged parts, stop using the product immediately and contact customer service.
- ⚠ Do not attempt to disassemble or replace any components yourself, as this may affect the stability and safety of the product.

Daily Maintenance

- Regularly clean the surface with a soft cloth to prevent dust accumulation.
- Do not use cleaning agents containing acids, alkalis, or corrosive substances, as they may damage the surface. It is recommended to use neutral cleaning agents or specialized furniture cleaners.
- Avoid exposing furniture to humid environments for extended periods. Use a dehumidifier or desiccant during humid weather.
- Avoid direct contact of furniture with water. If water is accidentally spilled, wipe it dry immediately.
- Avoid placing excessively heavy objects on the furniture: ensure the weight is within a reasonable load-bearing range.
- Avoid using sharp or rough items on the furniture surface to prevent scratches. Handle items gently when moving them.

Explosive view

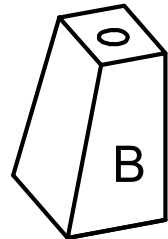
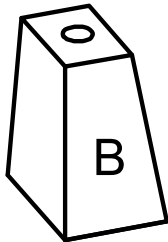
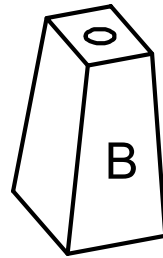
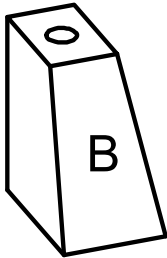
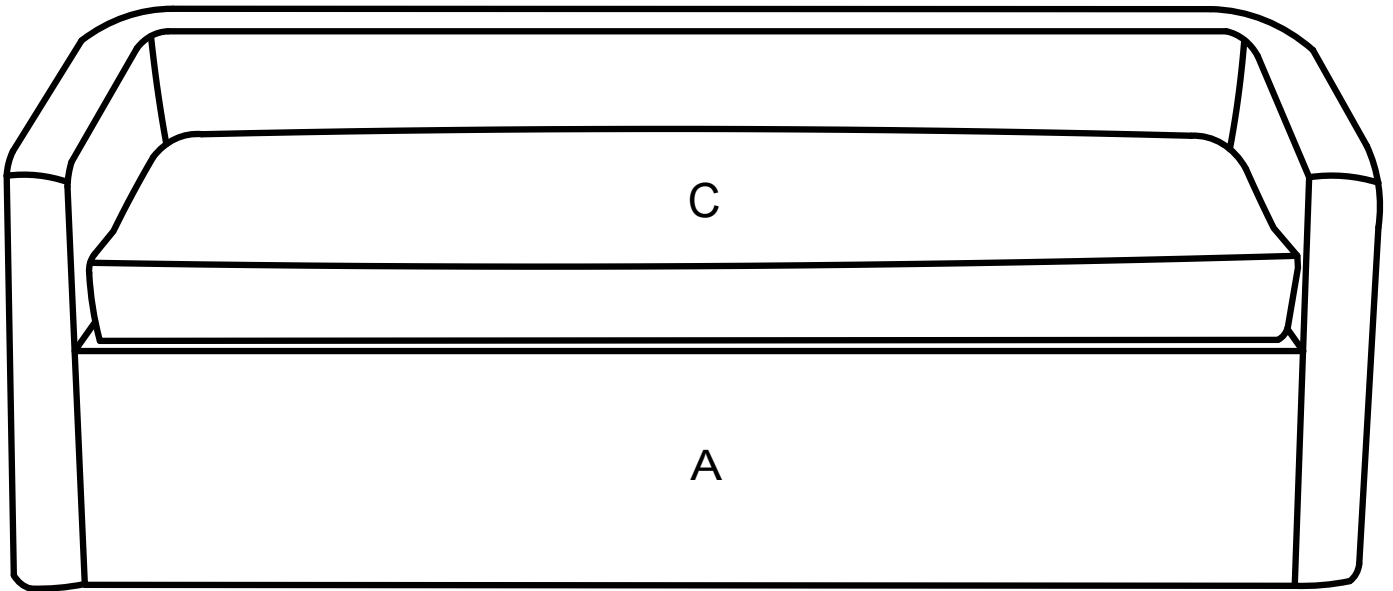

Parts list

Box

A x1

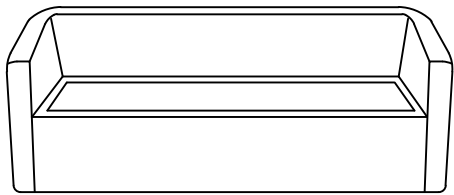

B x4

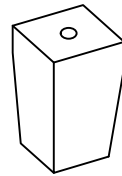

C x1

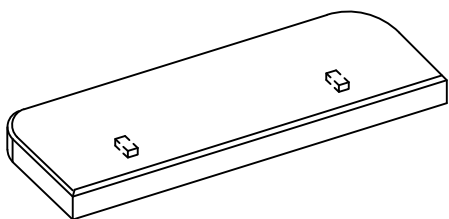

Hardware list

①x4+1

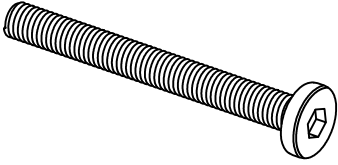

M8x140mm

②x4+1

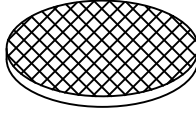

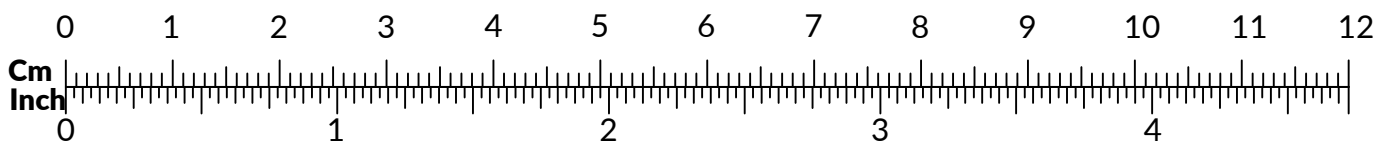

③x1

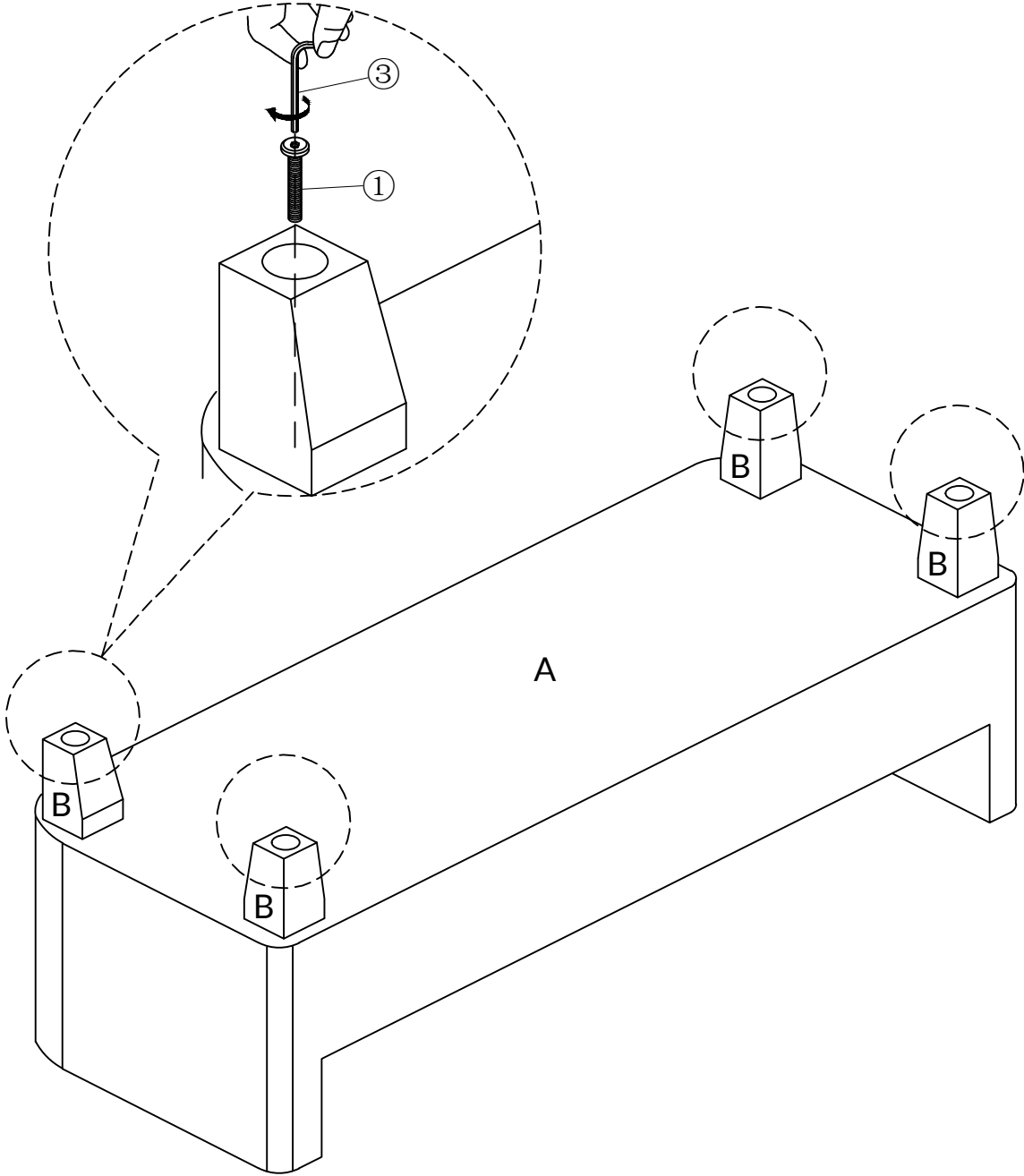

Note: Before installing the screws, please first distinguish the length of the screw rods.

Step 1



| | |
|---|---|
| ①x4 | ③x1 |
|  |  |
| M8x140mm | |

Step 2

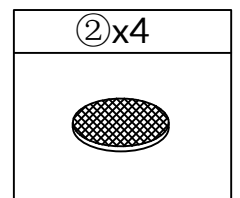
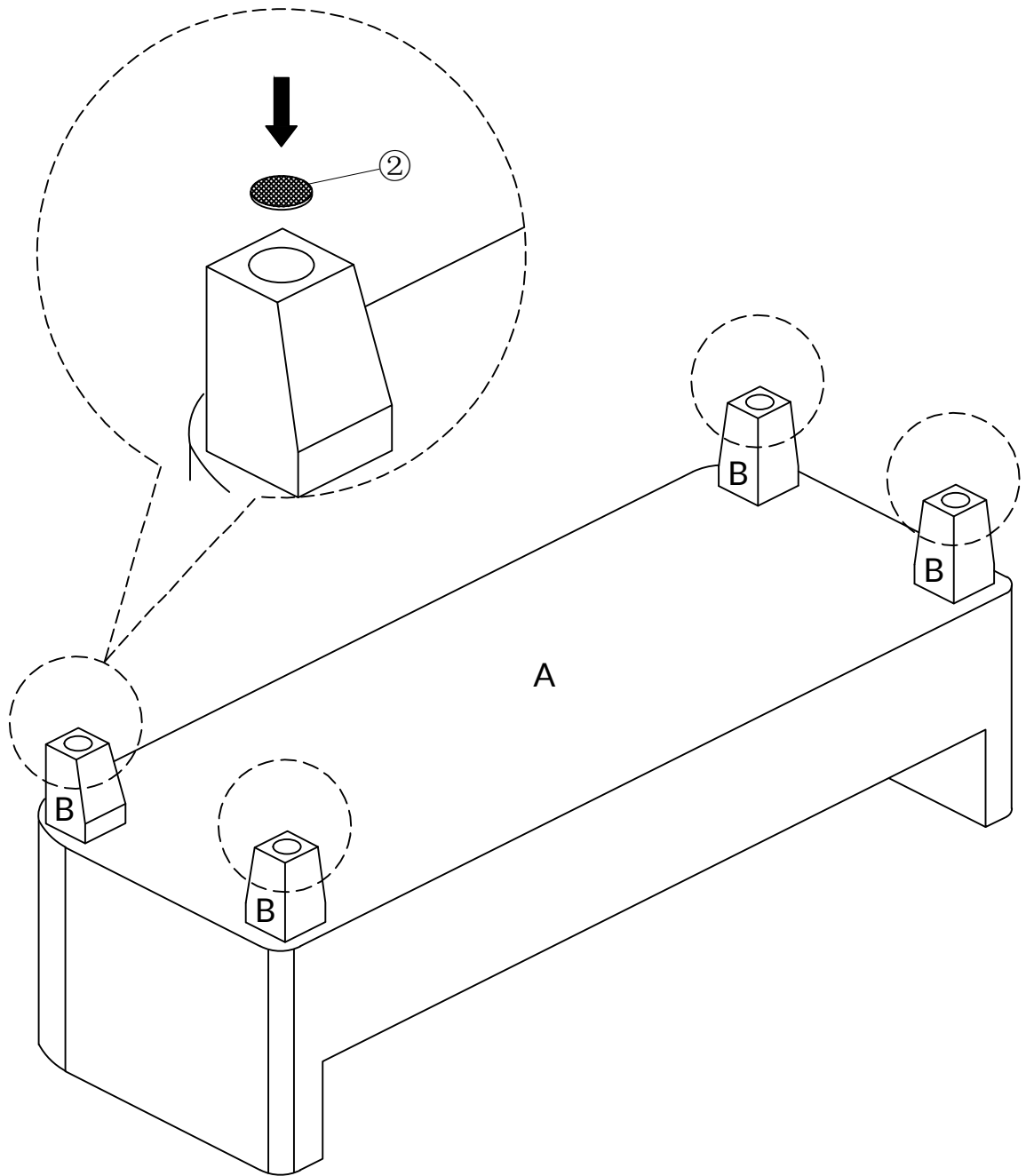

Step 3

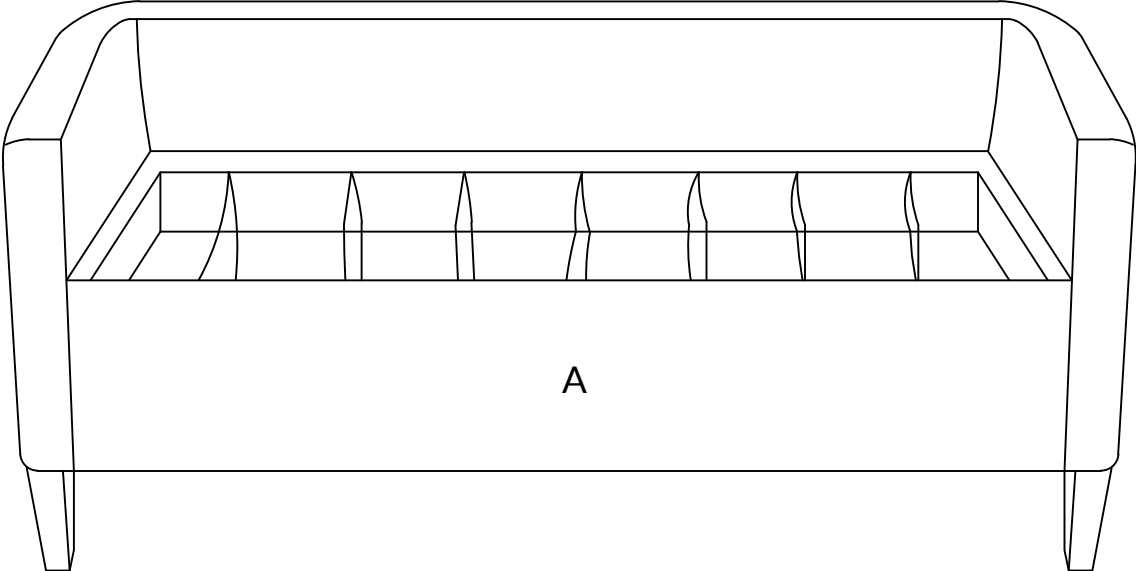

WARRANTY

- We strive to offer quality products, and we also try our best to satisfy every customer who orders from us with products or services as needed.
- Replacement parts can be purchased from our company if available.
- For returns, please check the return policy with the retailer or marketplace where you purchased the item.

We appreciate your purchase.
Brighten your life with our furniture!