

# Assembly Instructions

## ARMCHAIR

**CAUTION:** You must read this before you proceed.

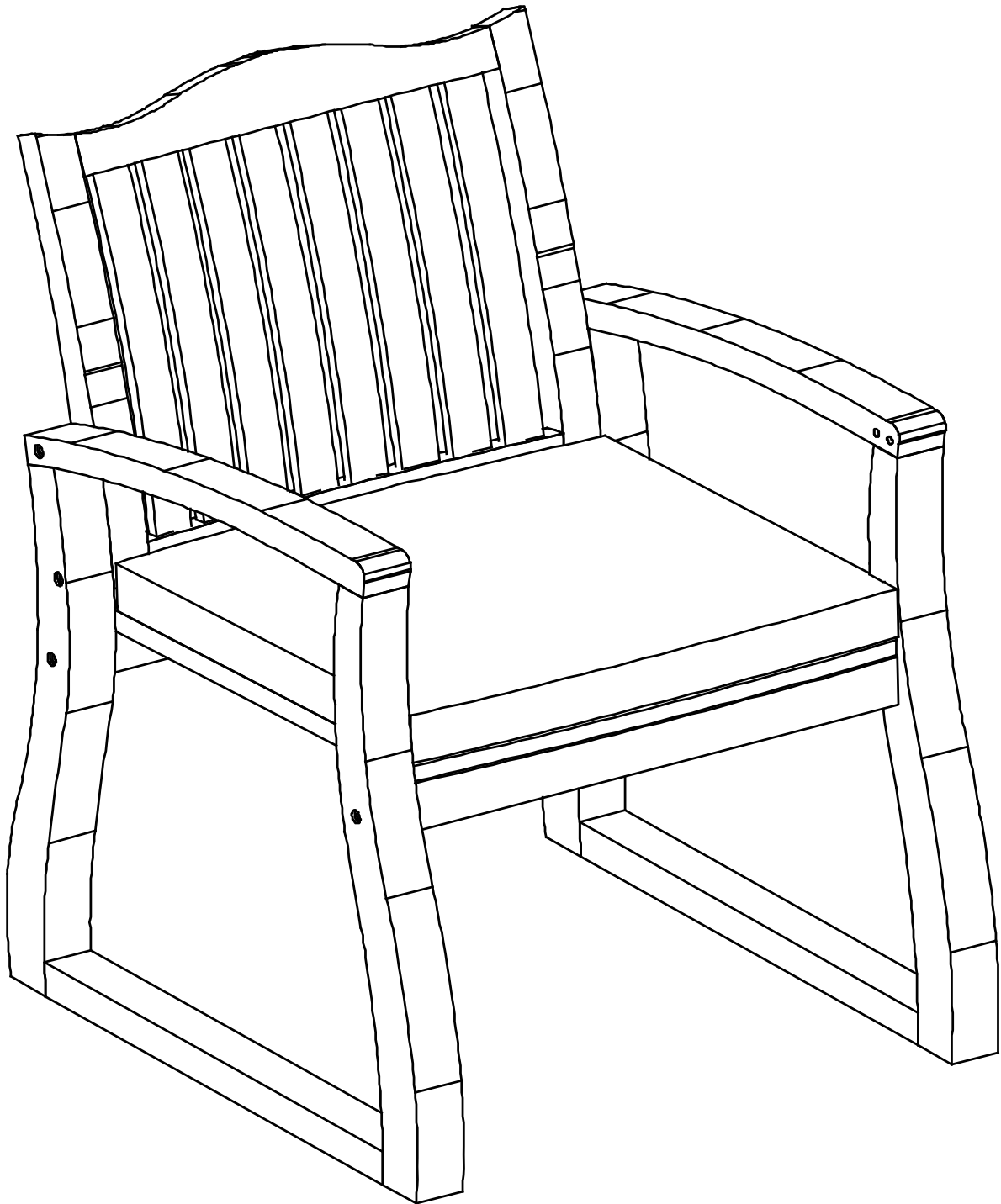

**CAUTION :** This Armchair is NOT a TOY.



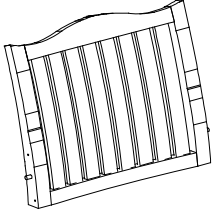
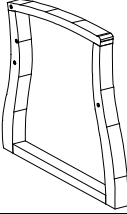
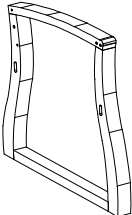
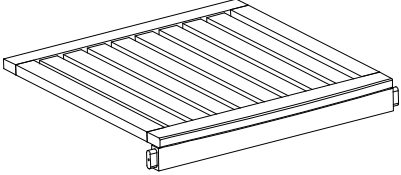
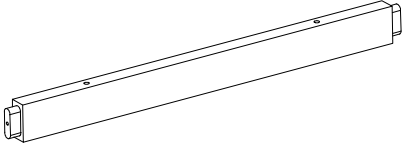
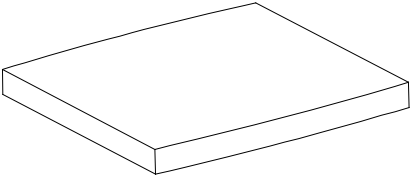

Keep your child / children at bay in the process of assembly.

For turning the Armchair and to prevent damage to the End Table, 02 persons may be needed to execute this action.

## Parts List

| No. | Picture                                                                             | Description     | Qty |
|-----|-------------------------------------------------------------------------------------|-----------------|-----|
| A   |    | Backrest Panel  | 1   |
| B   |    | Left Arm Panel  | 1   |
| C   |    | Right Arm Panel | 1   |
| D   |   | Seat Panel      | 1   |
| E   |  | Support Bar     | 1   |
| F   |  | Seat Cushion    | 1   |

## Hardware

| No. | Picture                                                                             | Description                | Qty |
|-----|-------------------------------------------------------------------------------------|----------------------------|-----|
| ①   |  | Long Screws<br>(M6x80mm)   | 5   |
| ②   |  | Medium Screws<br>(M6x70mm) | 5   |
| ③   |  | Short Screws<br>(M6x60mm)  | 3   |
| ④   |  | Allen Key                  | 1   |

# Assembly Preparation

## Before Beginning Assembly:

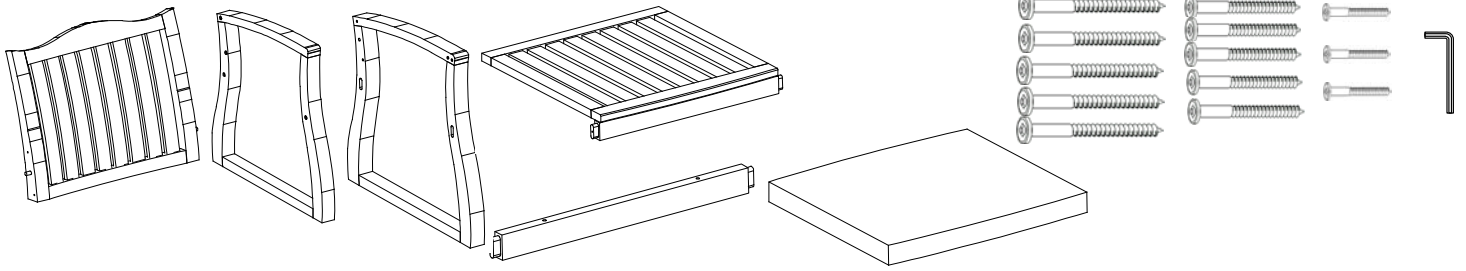

Read instructions, cover to cover.



Have 2 adults on hand for assembly.



Do not assemble on flooring or carpet.



Assemble on a clean non-marring surface (packing foam).



Save all packaging until finished.

## Assembly Steps

### OVERVIEW

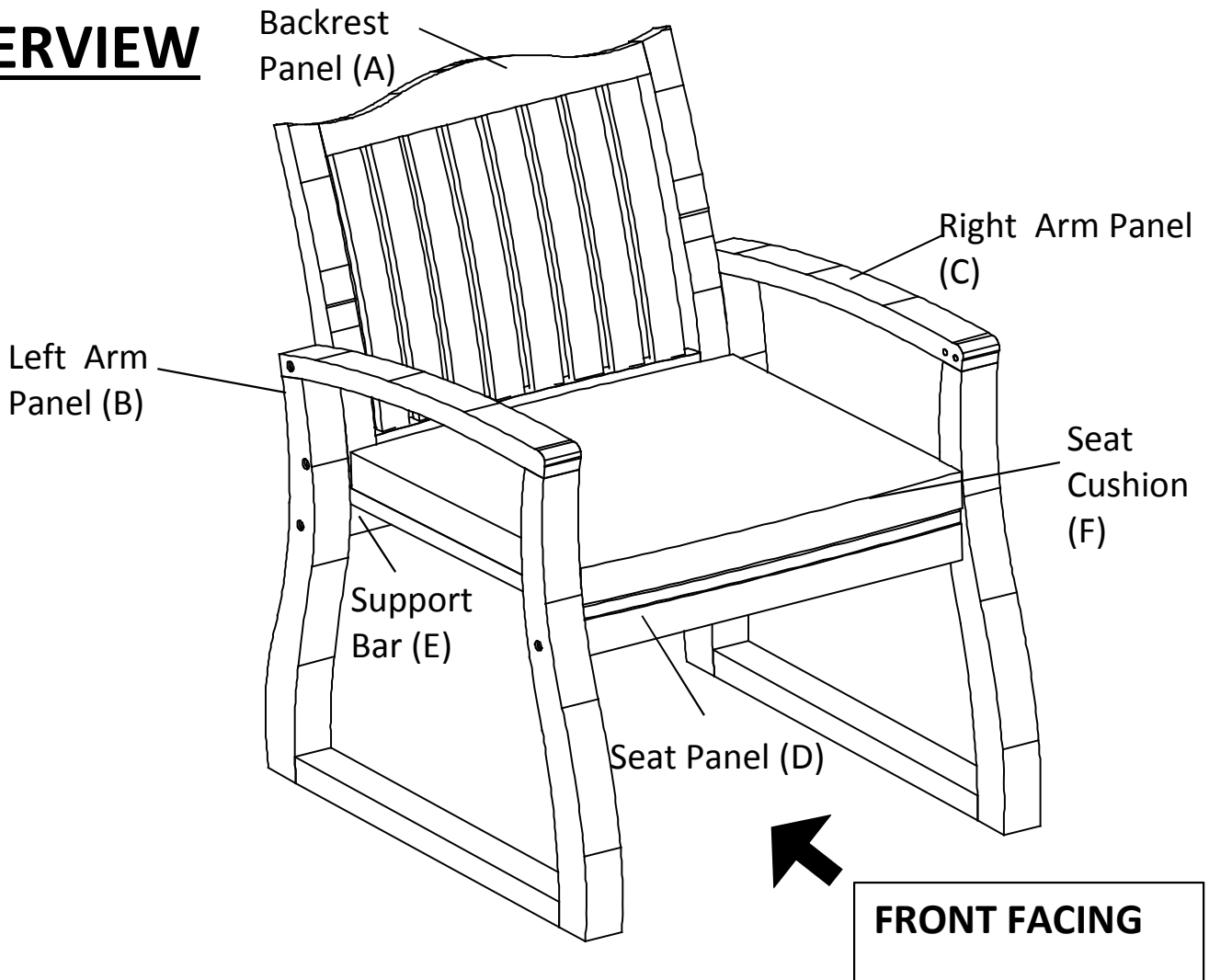

This Armchair has multiple parts and may require up to 30 minutes to assemble. To give you an overview of the Armchair parts, the above picture is to help you put the various parts into perspective. Please read through the instructions herebelow to familiarise the parts and steps before assembly.

### **Step 1**

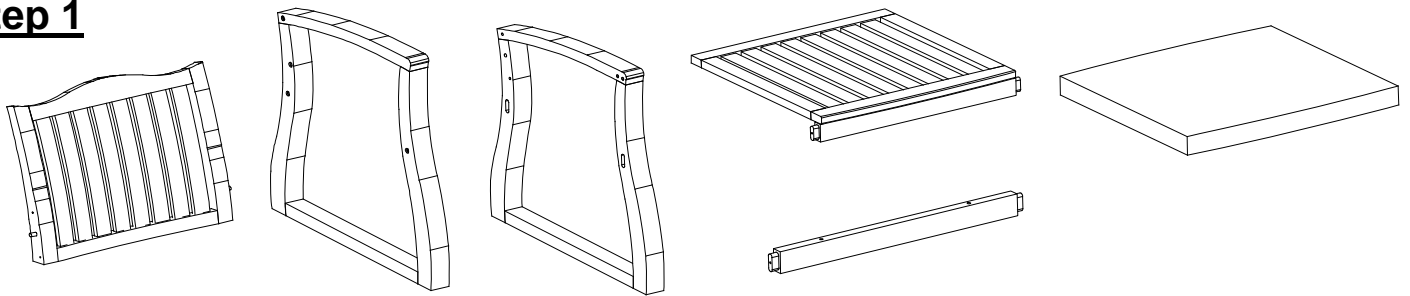

Unpack and place all parts on a clean, non-marring surface.

### **Step 2**

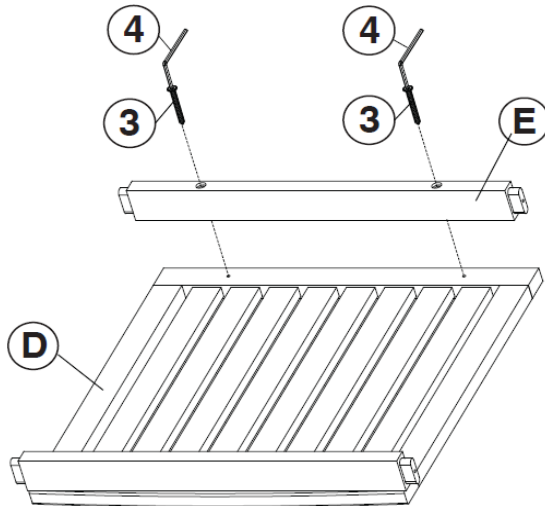

Place Support Bar (E) to the housings of Seat Panel (D), secure by using the Short Screws (3) and Allen Key (4), as shown in the picture.

**DO NOT FULLY TIGHTEN SCREWS.**

### **Step 3**

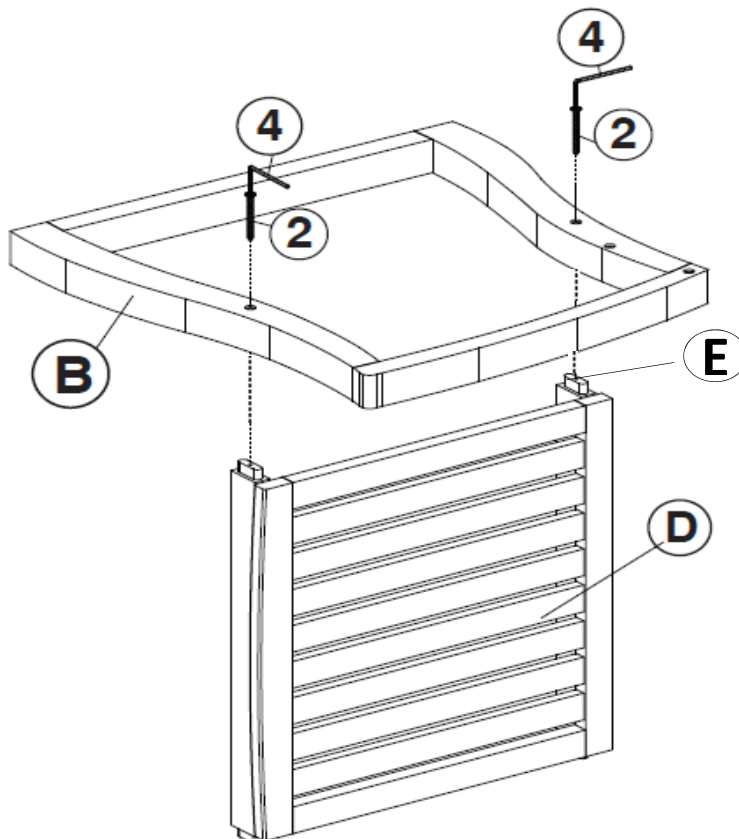

Place the Seat Panel (D) with its one side face skywards as shown in picture onto a clean, soft surface to avoid any scratches or damages to the product.

Align the tenon of Seat Panel (D) into the Mortise of the Left Arm Panel (B).

Then, affix Seat Panel (D) with Left Arm Panel (B) by using Medium Screws (2) and Allen Key (4).

**DO NOT FULLY TIGHTEN SCREWS.**

## Step 4

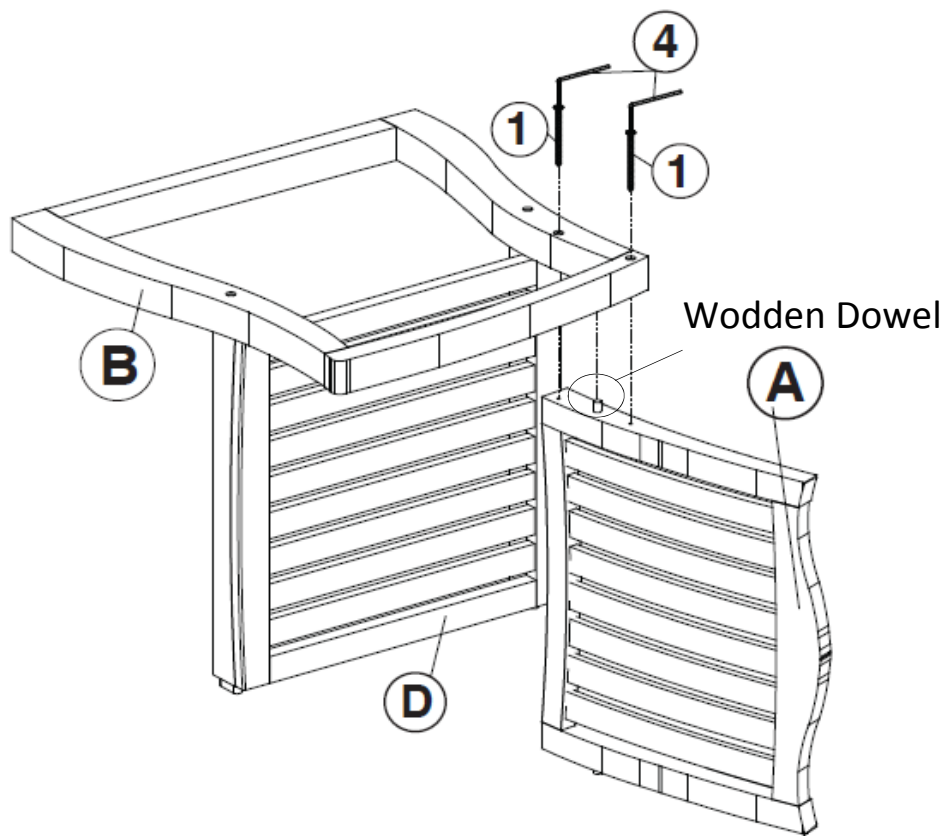

Then continue position Backrest Panel (A) as shown in picture above.

Align the wooden dowel into the positions in the arms.

Then, affix Left Arm Panel (B) with Backrest Panel (A) by using Long Screws (①) and Allen Key (④).

**DO NOT FULLY TIGHTEN SCREWS.**

## Step 5

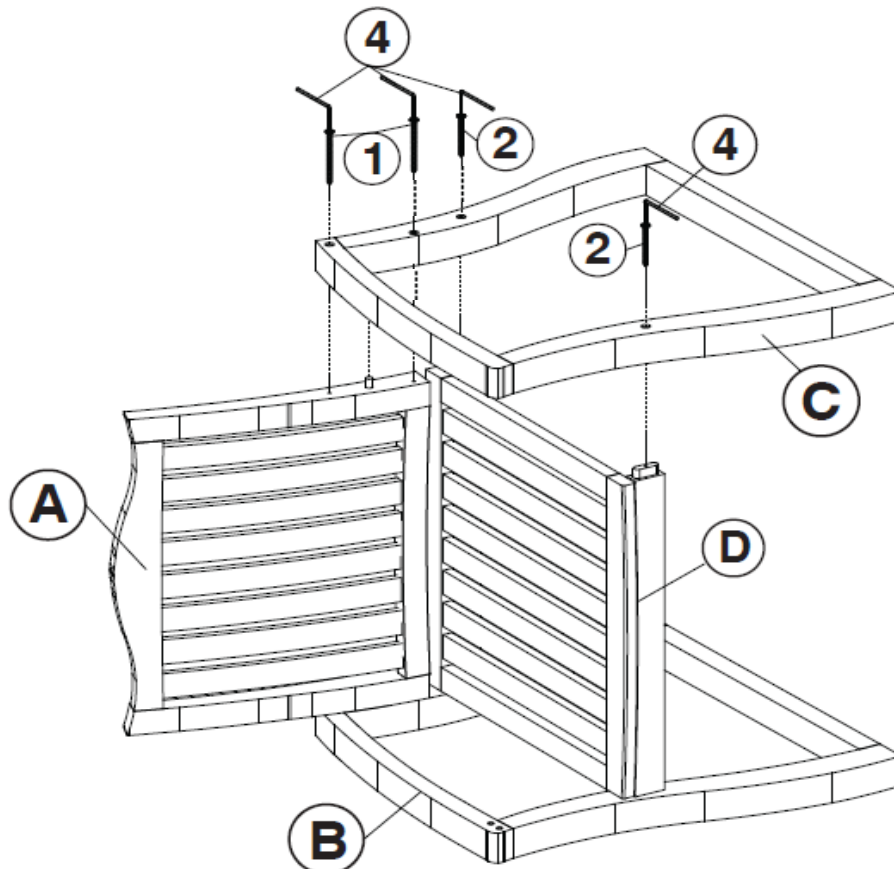

With the help from your partner, turn the Armchair to rest on Left Arm Panel (B) so that Right Arm Panel (C) is now facing skywards.

Repeat the same process by affixing Screws (①), (②), to designated points.

**DO NOT FULLY TIGHTEN SCREWS.**

## Step 6

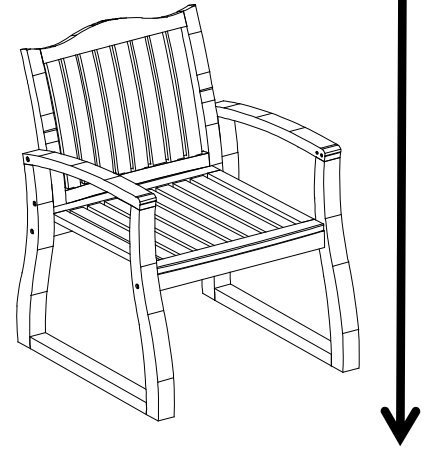
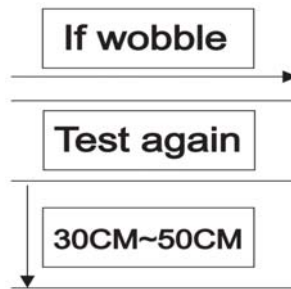
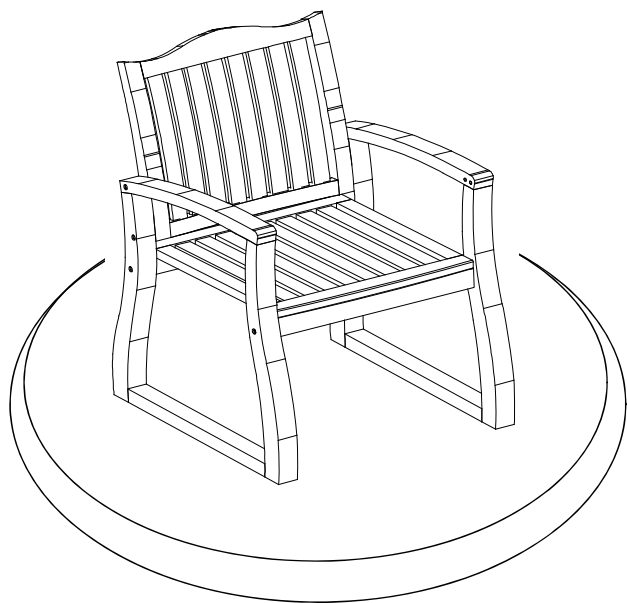

Turn the Armchair right side up  
Place the Armchair on a **LEVEL SURFACE** to see if it wobbles.

If it wobbles, lift the Armchair to some 30cm to 50cm height from the ground.  
Keep your feet and toes well away from the drop zone.  
Drop the Armchair freely and vertically with the four legs, hitting the ground, at the same time.  
This Drop Test will help to ensure that all the screws and gaps to all reach full alignment status.  
Test again for evenness on a **LEVEL SURFACE**.  
If no wobbles found, proceed to tighten all the screws.

**CAUTION: When tightening these screws, tighten sequentially.  
DO NOT tighten any screw fully and then towards the next one.  
This would cause the frame to warp.**

**If there is still wobbles, loosen the screws and execute this same drop tests.**

**WARNING ! IF ARMCHAIR IS NOT STABLE , IT COULD LEAD TO DAMAGING THE PRODUCT.**



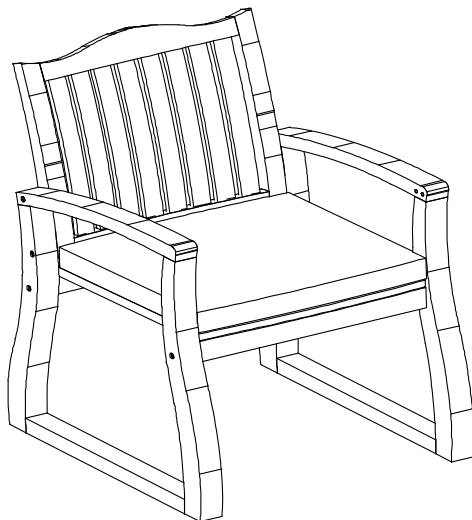





## Step 7



Turn the chair right side up.  
Place Seat Cushion (F) to Seat Panel (D).  
Inspect it and make sure all parts are adequately connected.  
Ensure all screws are fully locked into position and secured.  
The Armchair is ready to be used.

**Caution: This Armchair can only be used on a flat, level surface.**

## Care & Maintenance

-   Do not put hot items directly on furniture surface.
-   Do not clean furniture with harsh cleansers or polish.
-   To obtain the longest lifespan of your outdoor products, minimizing exposure to direct sunlight is recommended.
-   Children should not climb or jump on the furniture.
-   Do not write on furniture without a padded barrier to protect the surface.
-   To obtain the longest lifespan of your outdoor products, avoid extended and lengthy exposure to rain, snow, and direct sunshine. Whenever possible cover the product and /or place under patio or awnings.
-   Not for commercial use. For residential use only.
-   Stains may be removed with mild soap solution and damp cloth.
-   Dust and pick-up spills using a clean, non-colored, lint-free cloth.

### What is Proposition 65?

Proposition 65 is a California law that requires warning labels on products that may contain one of more than 800-plus chemicals or ingredients that the California Office of Environmental Health Hazard Assessment (OEHHA) has deemed to cause cancer or other reproductive toxicity. Chemicals and elements on this list include wood dust, brass, and other everyday substances, which can be found in very common household items, such as: lamps, tableware, jewelry, crystal glasses, electric cords, beauty products, automobiles, and furniture.

### Why Did I Find a Proposition 65 Warning on My Home Goods Product?

We include Proposition 65 warnings on all of our products because there is always a chance that one of the 800-plus common chemicals and ingredients listed under this law could potentially be on our furniture or packing materials. We risk large fines under this law, if we don't include this warning.

### Should I worry?

We realize you may be worried finding this warning on our products, but we want to reassure you that the hazardous exposure limits for any of these chemicals have never been found on furniture products that we've shipped to our customers. Additionally, this warning label is very common and can be found on almost every piece of furniture sold in the state of California.

### Just How Common Are Proposition 65 Warnings?

Proposition 65 warnings have become so common in California that it is hard to take a trip to a local bank, grocery store, or restaurant without finding at least one warning. In fact, even the Disney Land Resort has a Proposition 65 warning:

