









ASSEMBLY INSTRUCTIONS

DP-6037

BILL OF MATERIALS

12	wrench	1	
11	Allen key	1	
10	glass holder	12	
9	castor	4	
8	shim	4	
7	screw	18	
6	cover	18	
5	stopper	18	
4	tube with hole	1	
3	tube	2	
2	plate	2	
1	baseplate	1	
No.	ITEM	QTY.	PHOTO

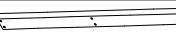
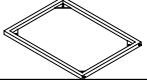
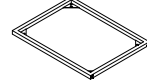
EXPLODED DIAGRAM

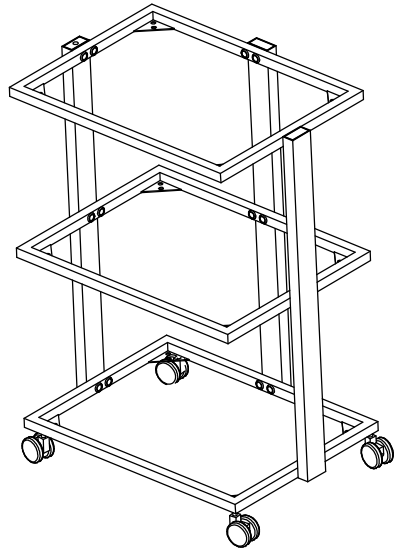

STEP1

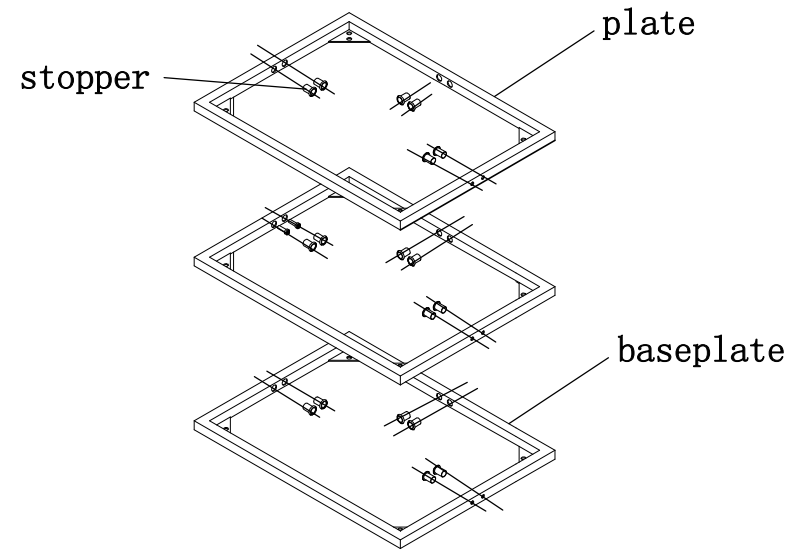

baseplate has four additional holes for castors

STEP2

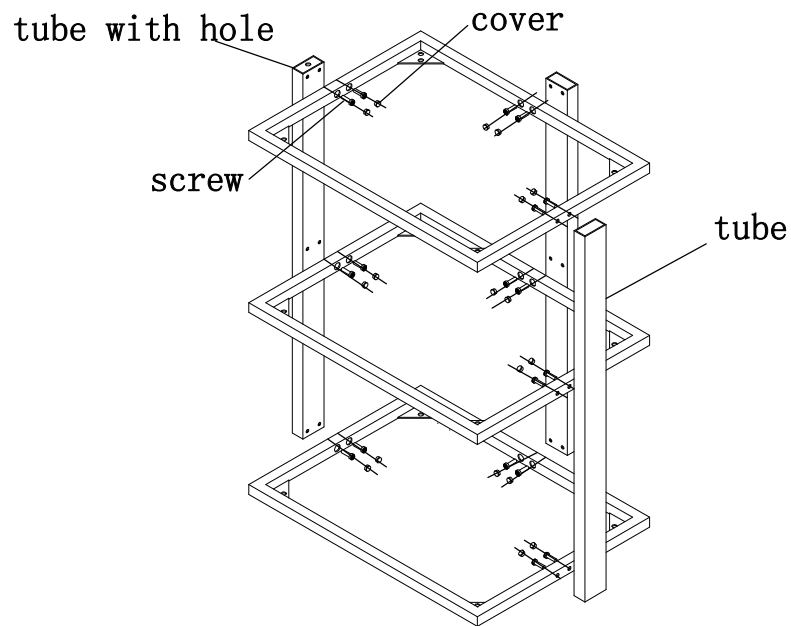

STEP3

