

NIGHT STAND

Assembly Instruction

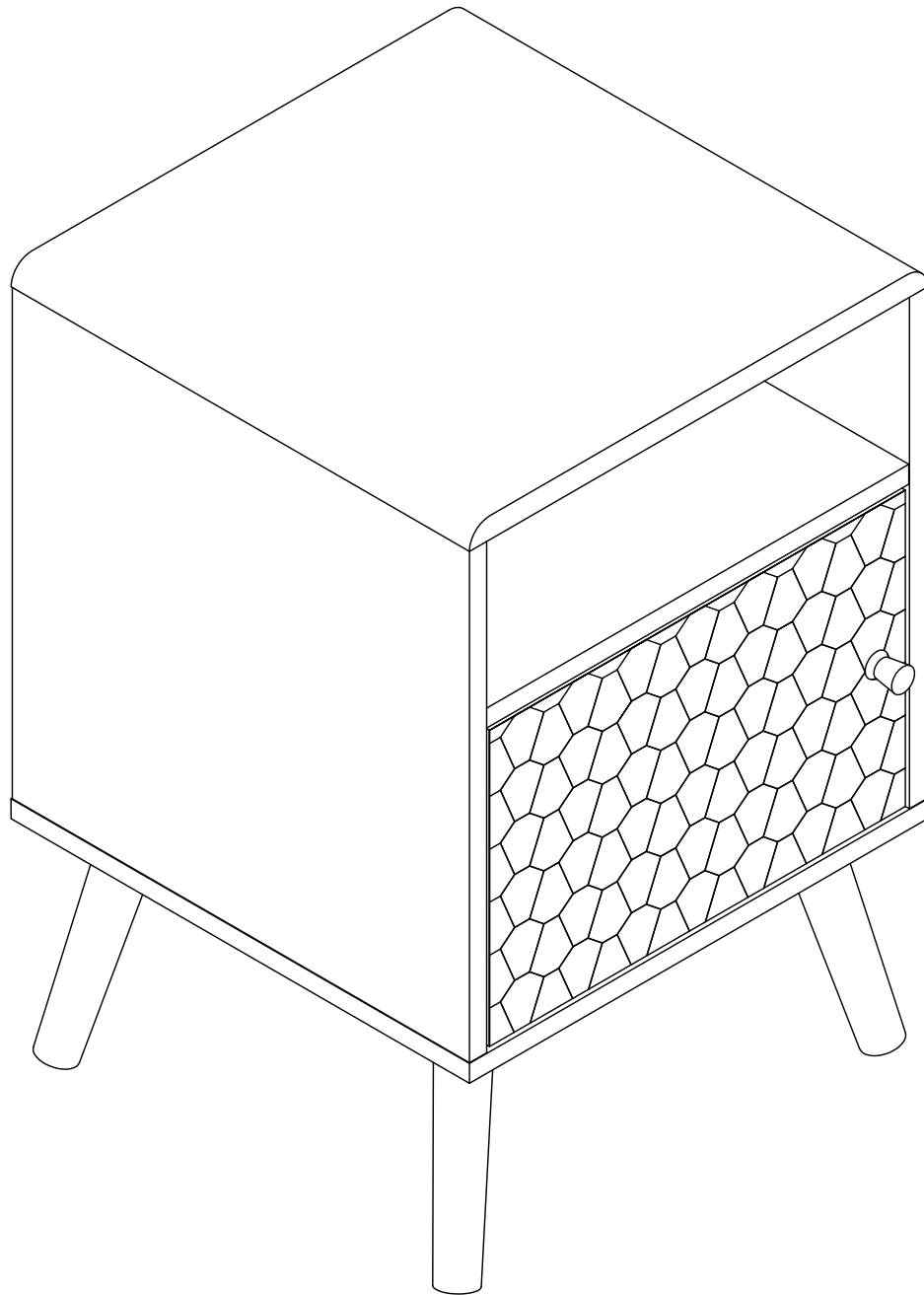

General Assembly Guidelines



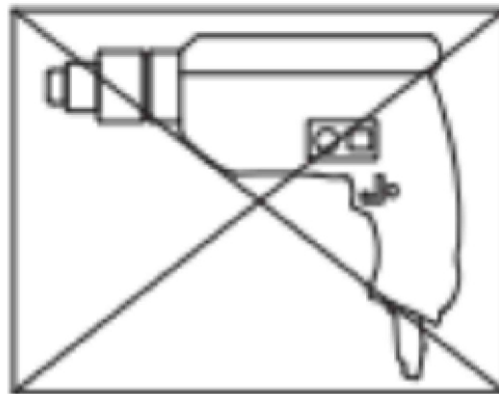



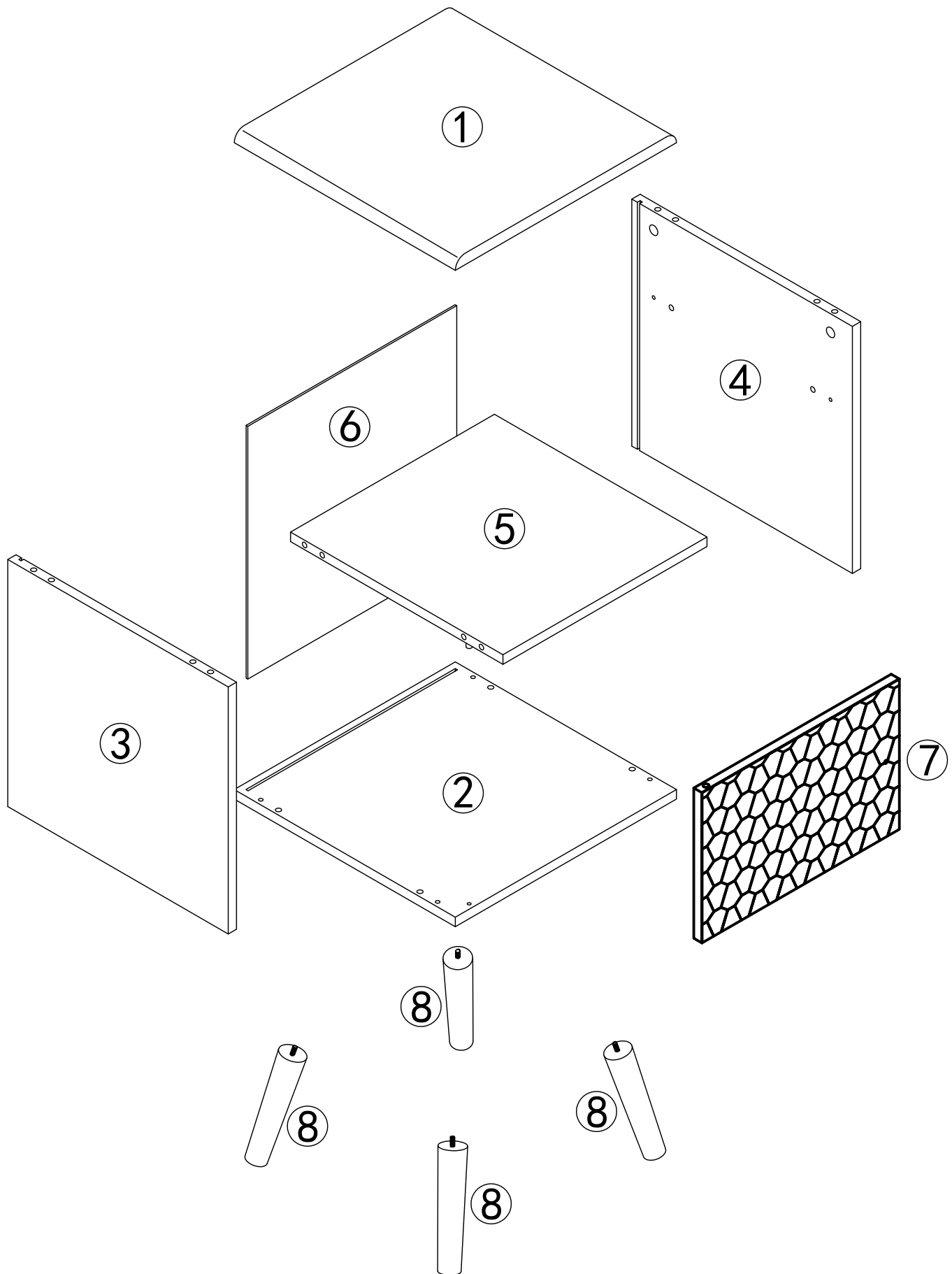



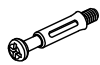



- I. Ensure that all parts and hardware are available before beginning assembly.
- II. Follow each step carefully to ensure the proper assembly of this product.
- III. Two people are recommended for ease in the assembly of this product.
- IV. The three main types of hardware used to assemble this product are: hex key, footpads and bolts.
- V. Power tools should not be used to assemble this product.



Parts List



Hardware List

A		M6x35mm	Screw	8 pcs
B			Screw	8 pcs
C		M3.5x14mm	Bolt	16 pcs
D			Iron sheet	4 pcs
E		M4	Hex Key	1 pc
F		M5x40mm	Bolt	4 pcs
G			Cork	12 pcs
H		M4x20mm	Bolt	1 pc
I			Door handle	1 pc
J			Magnet	1 pc
K			Iron sheet	1 pc
L		M3x12mm	Bolt	2 pcs
M			Door shaft	2 pcs
N		M3x12mm	Bolt	2 pcs

Cam Lock Fastening System

Insert the cam bolt into the hole first, then insert the cam lock and lock it.

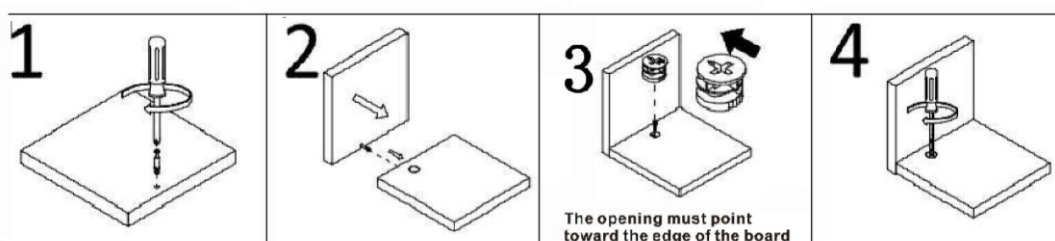

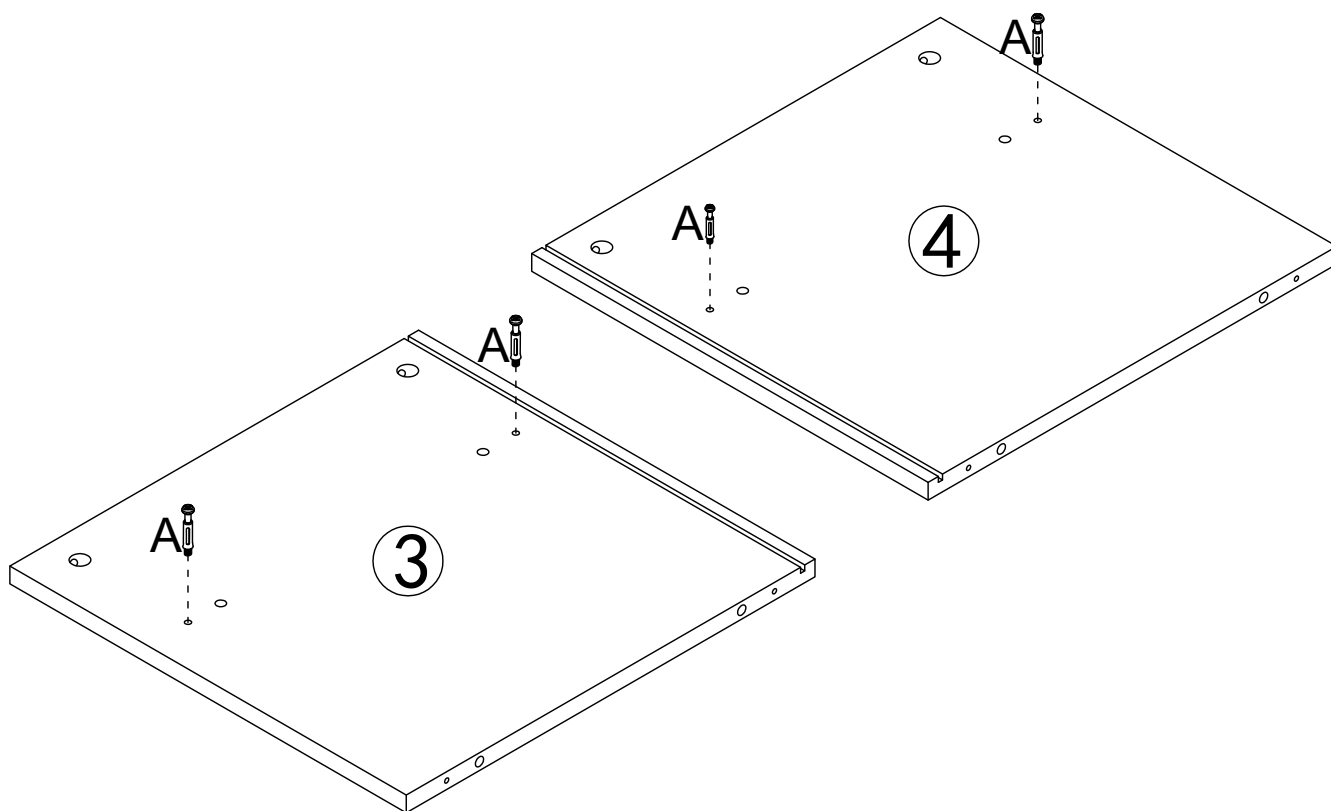

Step 1

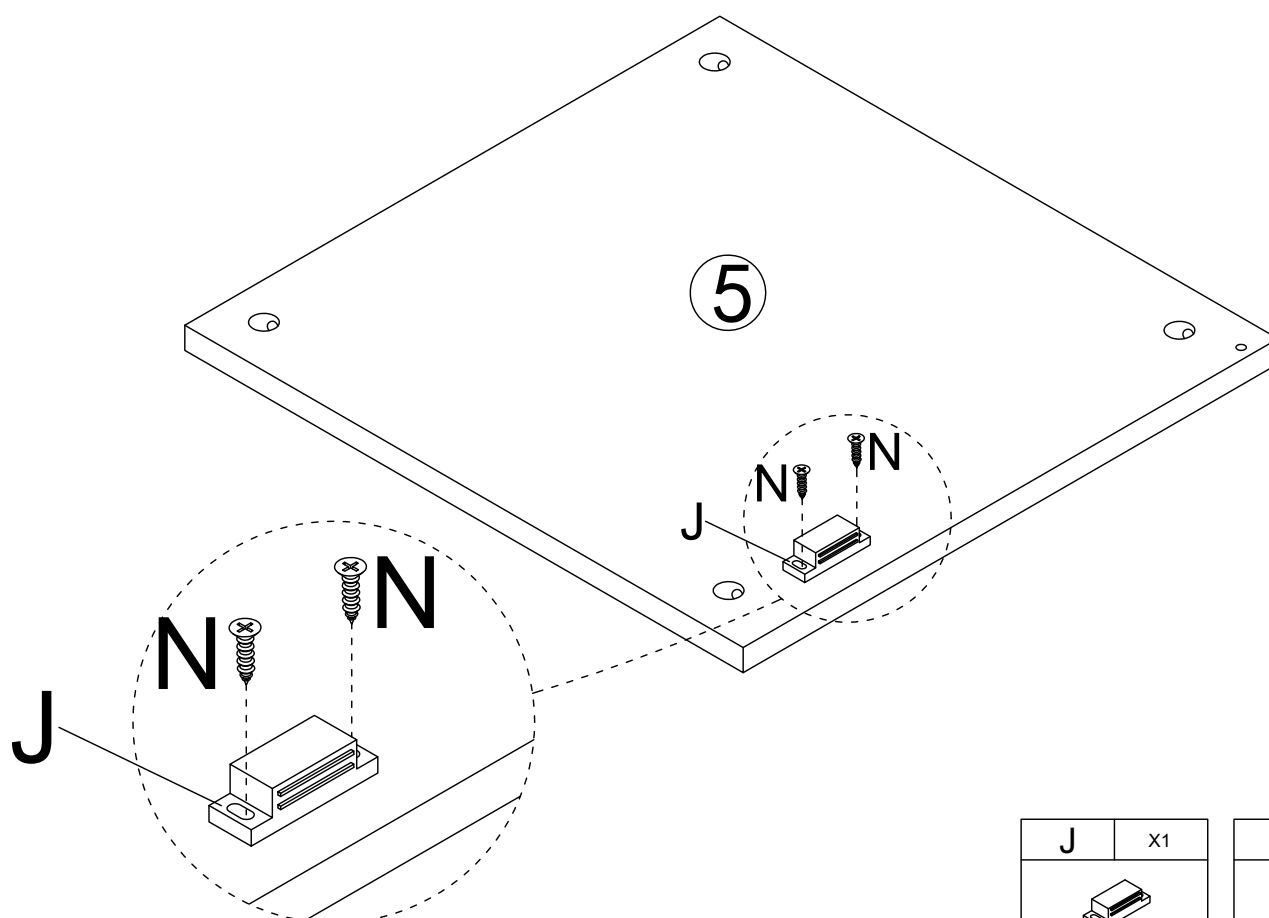

A	x4
	
M6x35mm	

Step 2



J	x1
	

N	x2
	
M3x16mm	

Step 3

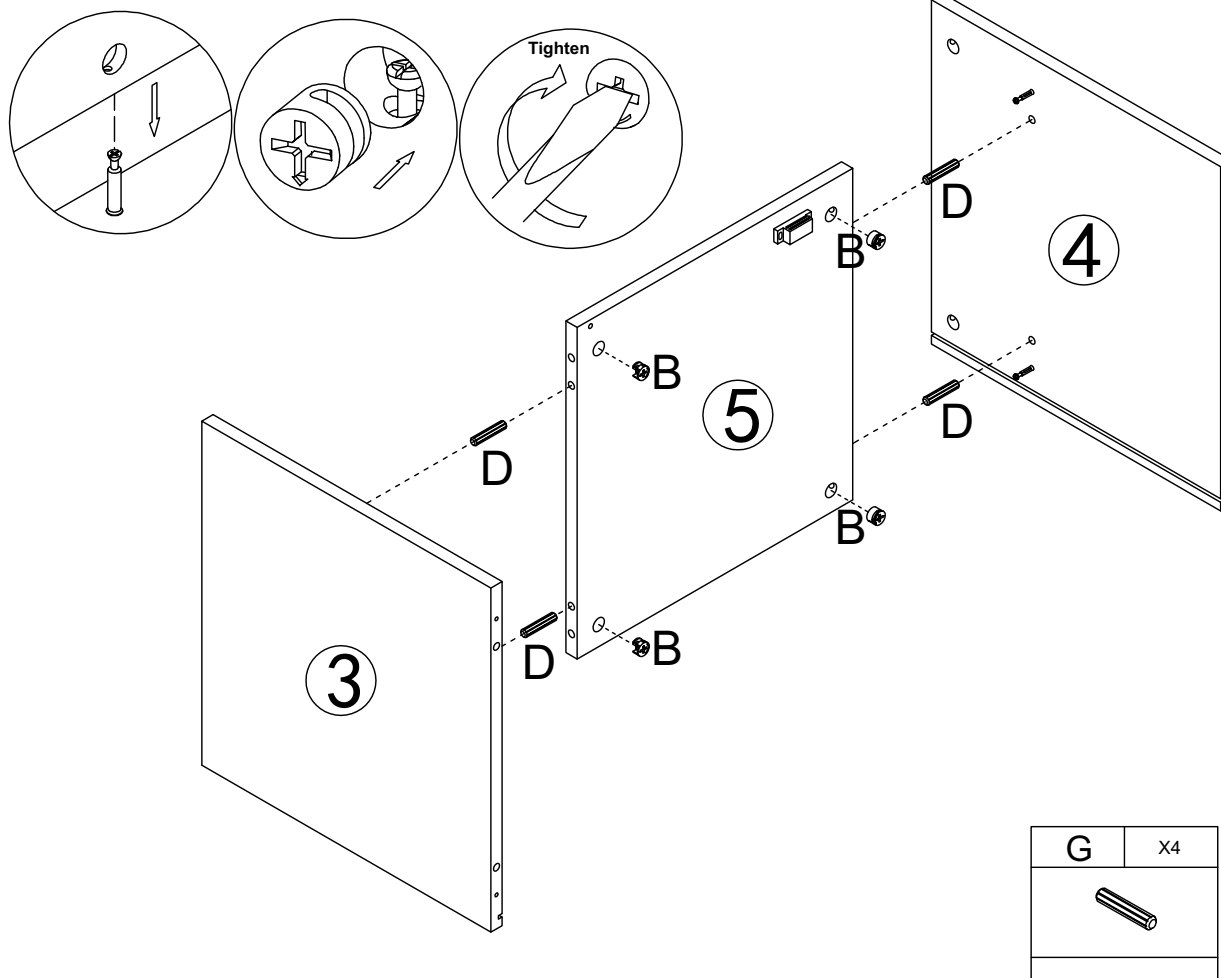

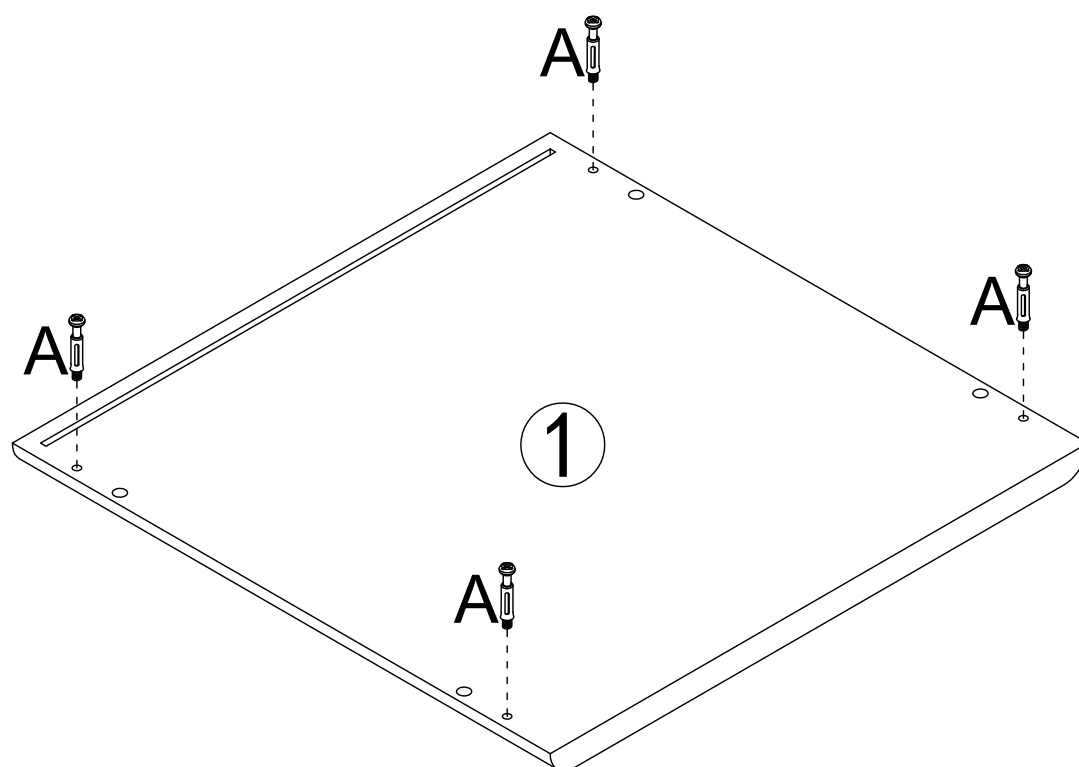

Step 4

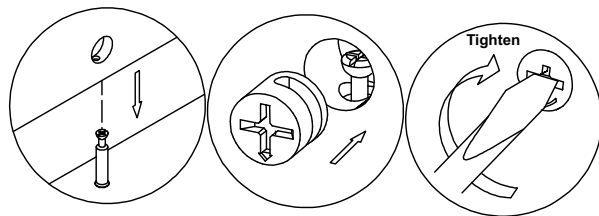
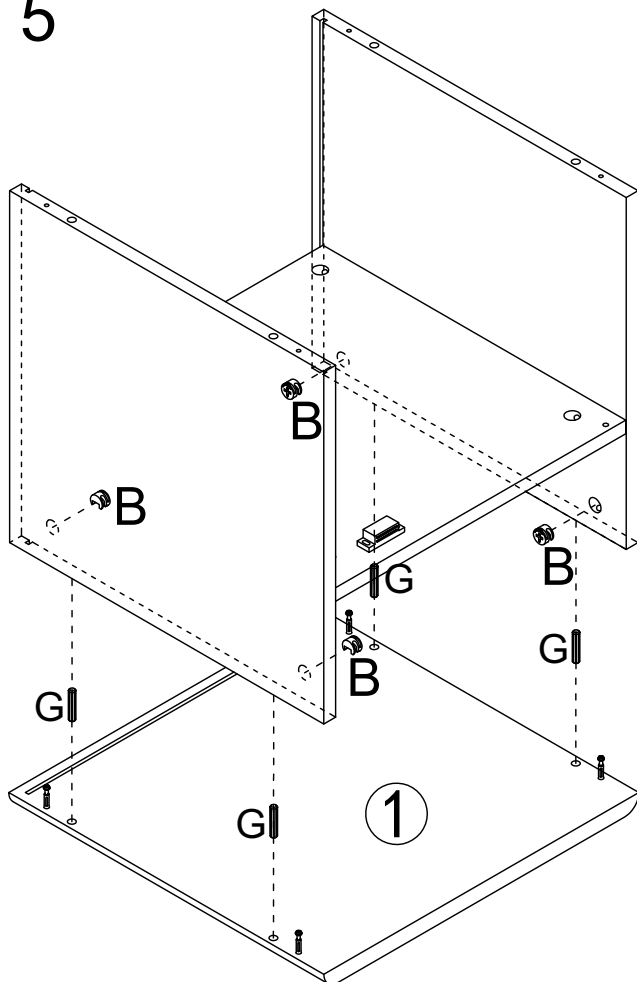

A	x4
M6x35mm	

Step 5



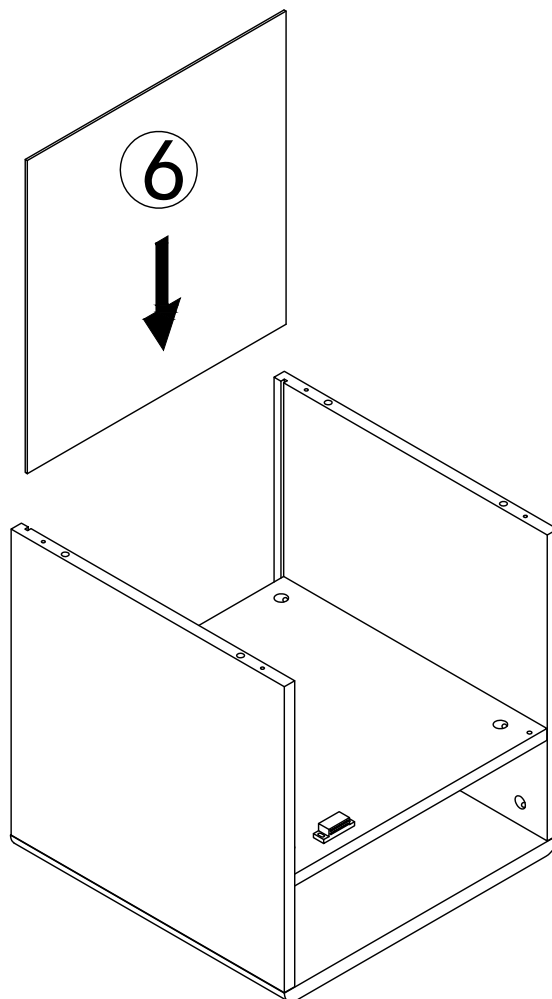

G	x4	B	x4
			

Step 6

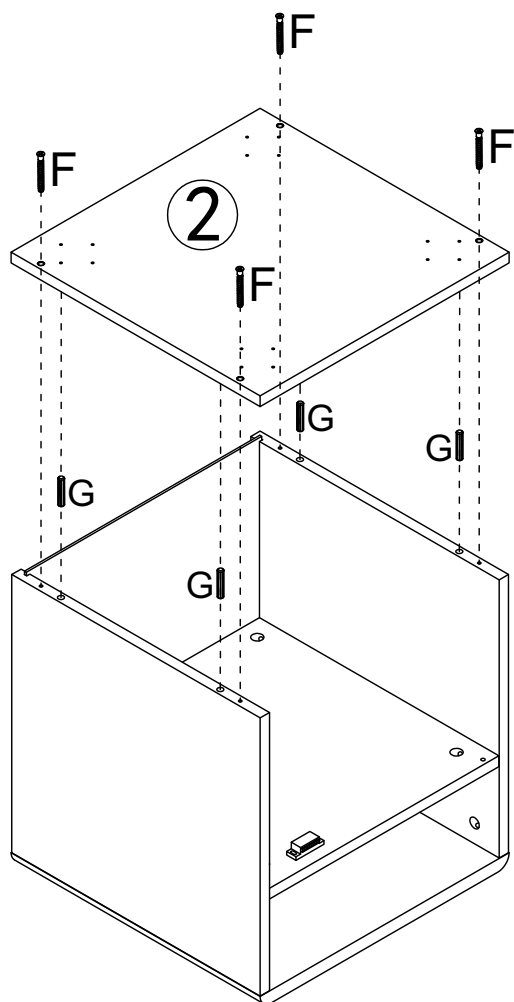

Step 7





G	x4
	

F	x4
	
M5x40mm	

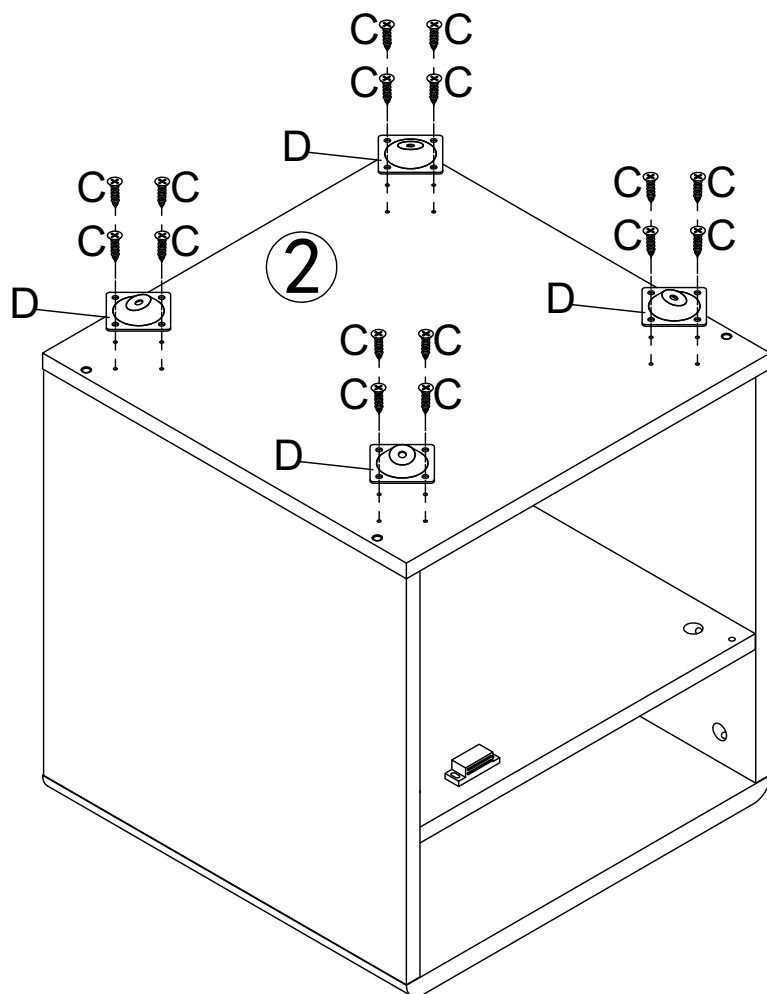
Step 8



D	x4
	

C	x16
	
M3.5x14mm	

Step 9

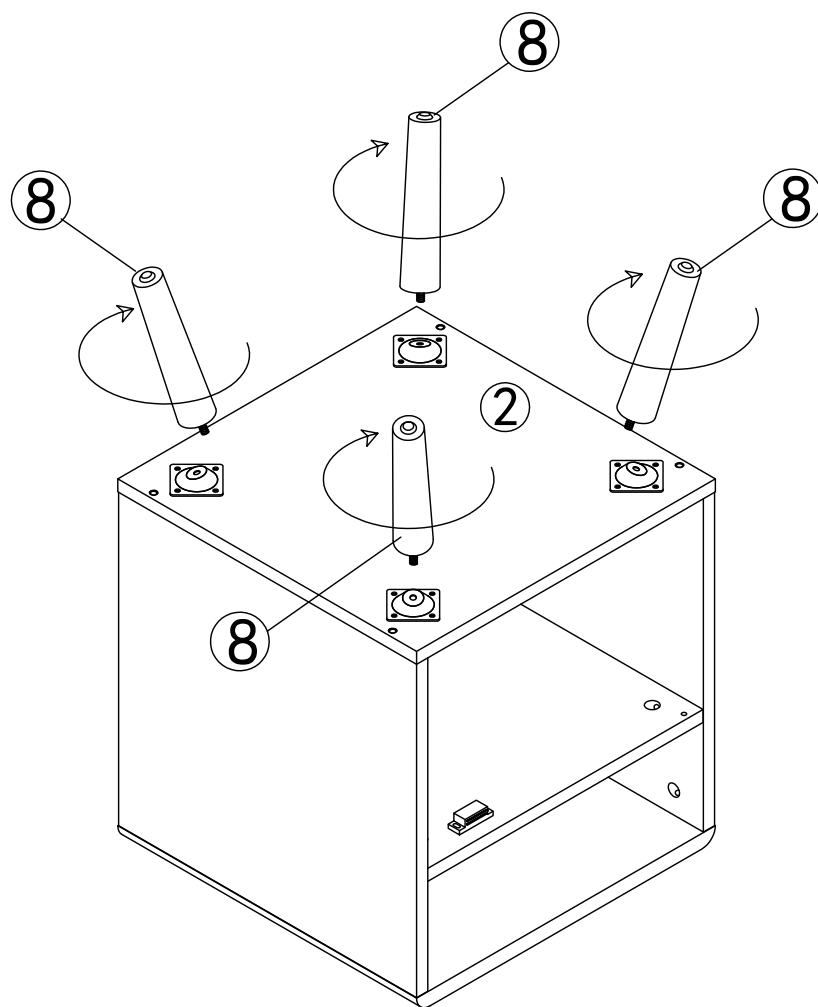

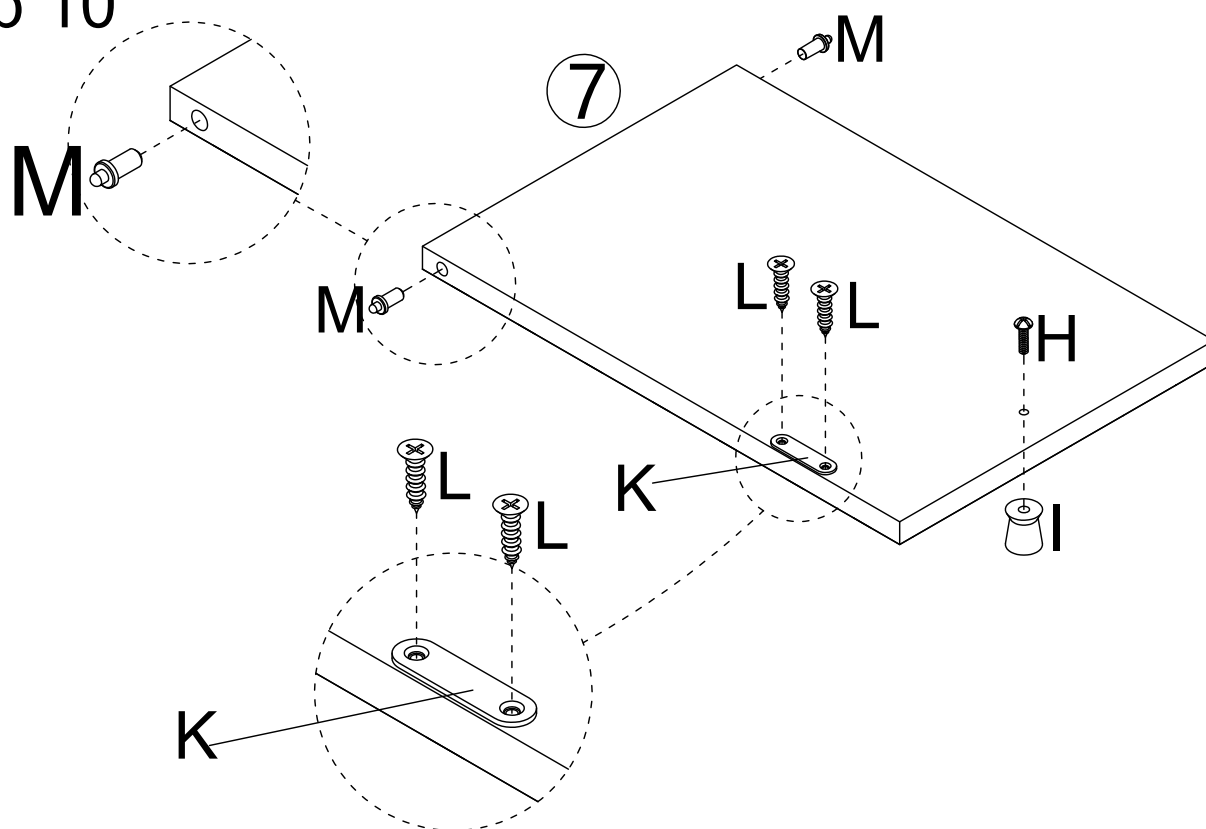

Step 10



L	X2
	
M3x12mm	

I	X1
	

H	X1
	
M4x20mm	

K	X1
	

M	X2
	

Step 11

