

ASSEMBLY INSTRUCTION

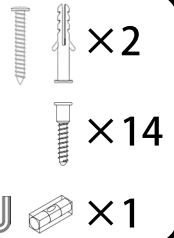

Large screw holes facing out

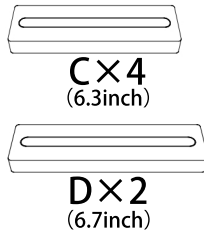
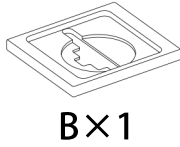
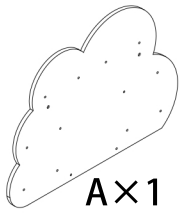
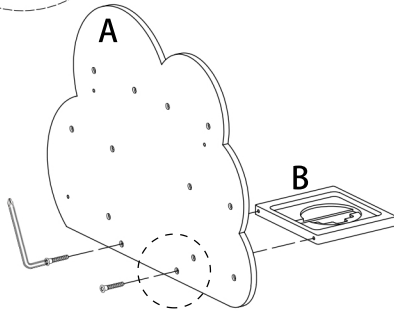
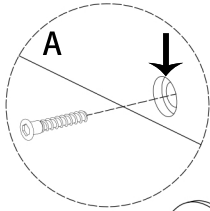

Connecting Part A B.

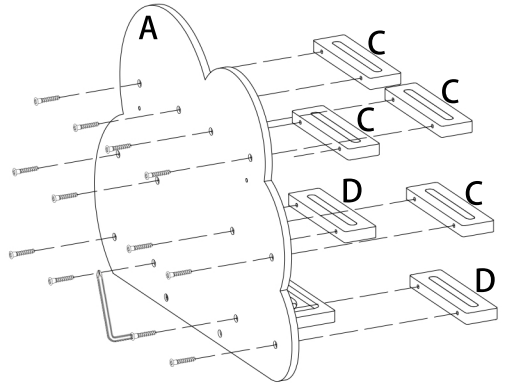

Connecting Part A C D.

Mark the place where you want to install the shelf and check with a level.

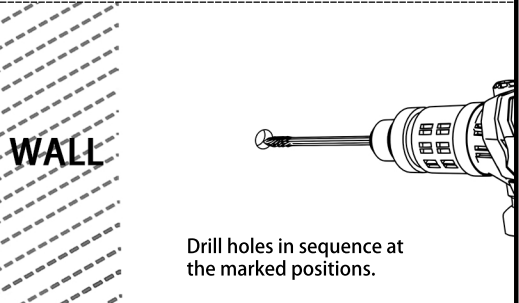
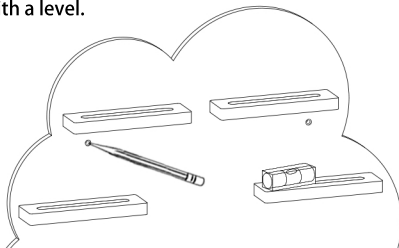

Use a hammer to hammer the expansion tube into the drilling hole.

Use screwdriver to screw the long screws into the expansion tubes.

WALL

