

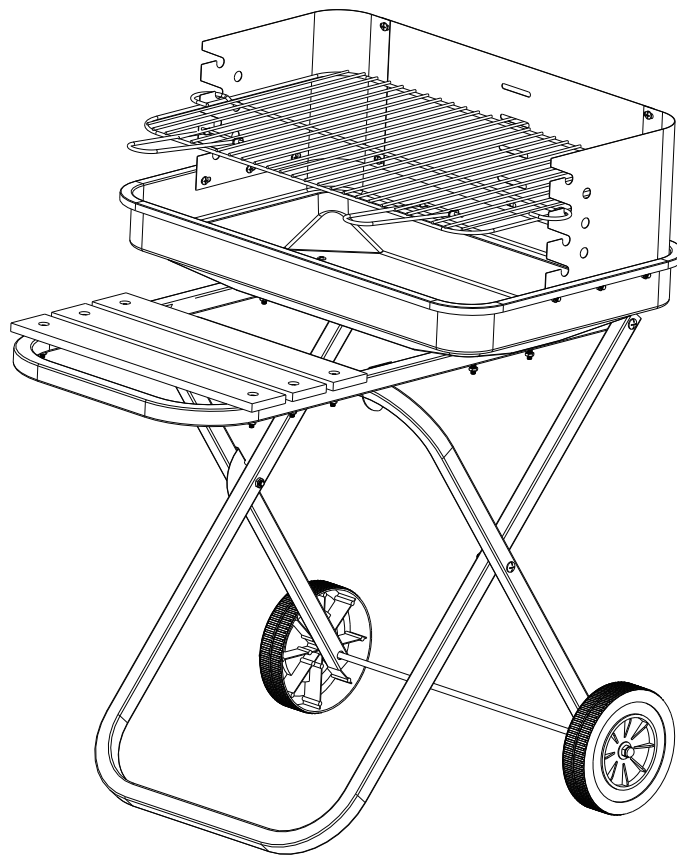

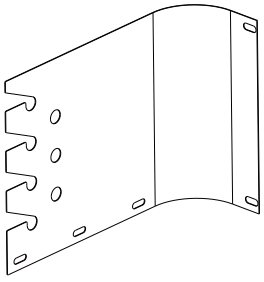

# Assembly Instructions

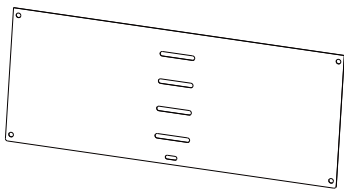
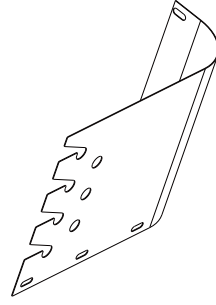
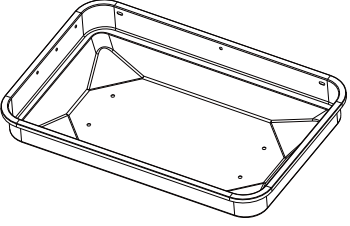
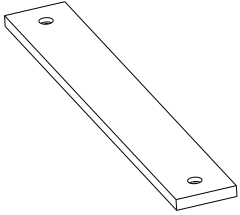
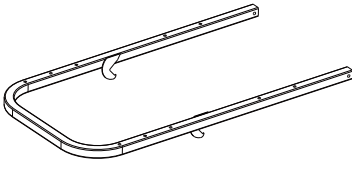
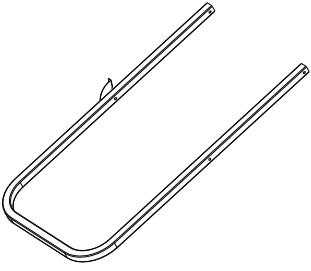
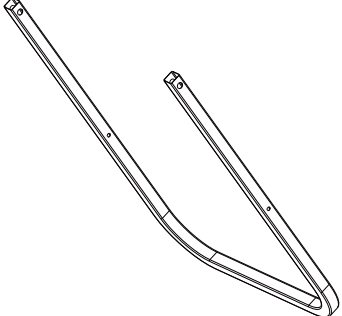
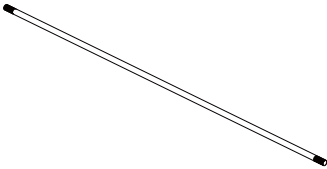
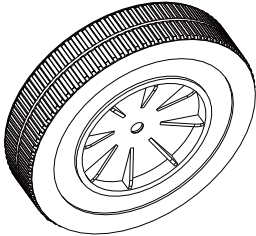
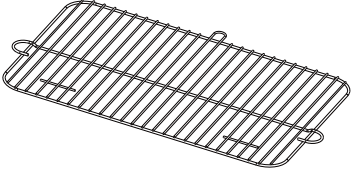
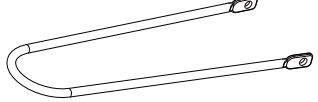

**Charcoal Barbecue 4**

# Part List

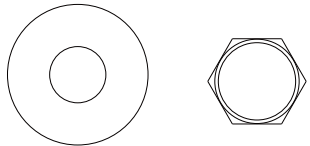
<p>① X1PC</p> 	<p>② X1PC</p> 	<p>③ X1PC</p> 	<p>④ X1PC</p> 
<p>⑤ X3PCS</p> 	<p>⑥ X1PC</p> 	<p>⑦ X1PC</p> 	<p>⑧ X1PC</p> 
<p>⑨ X1PC</p> 	<p>⑩ X2PCS</p> 	<p>⑪ X1PC</p> 	<p>⑫ X2PCS</p> 
<p>AXM5X10mmX9PCS</p> 	<p>BXM6X30mmX10PCS</p> 	<p>CXM6X55mmX4PCS</p> 	<p>DXM8X2PCS</p> 



## **Special Warnings**

- This Charcoal Barbecue 4 is intended for Outdoor Use Only!
- DO NOT use indoor !
- This barbecue will become very hot, do not move it during operation!
- Do not use spirit, petrol or any similar liquid for lighting or re-lighting!
- Keep children and pets away.

## **Operation Instructions**

- All screws must be firmly driven in.
- Every care has been taken in the production process to eliminate sharp edges on your grill . Please handle the parts with care so as to avoid accidents or injury during assembly and when in cooking .
- Always wear gloves when moving the grill, because the grill handles can become very hot during cooking .
- Always select a safe and level location in a place suited for charcoal barbecue. Do not transport the grill when it is still hot.
- It is dangerous to attempt to operate the grill with liquid fuels.
- Before first cooking it is recommended to heat the grill and bring the coals to a glowing heat for at least 30 minutes.

## **Care and Maintenance**

Heap charcoal pieces into a pyramid in the fuel bowl .

Position dry charcoal lighters evenly through this pyramid of coals.

Light the pyramid using a match.

Do not load the grill with meat until the coals are covered with a layer of ash.

Oil grilling skewers with a little vegetable oil and begin your barbecue.

# ■ Assembly Instructions

Estimated Assembly Time: 30 Minutes

**DO NOT over tighten hardware!**

