

Top View

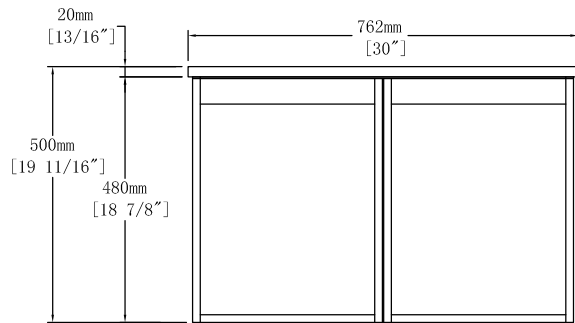

Front View

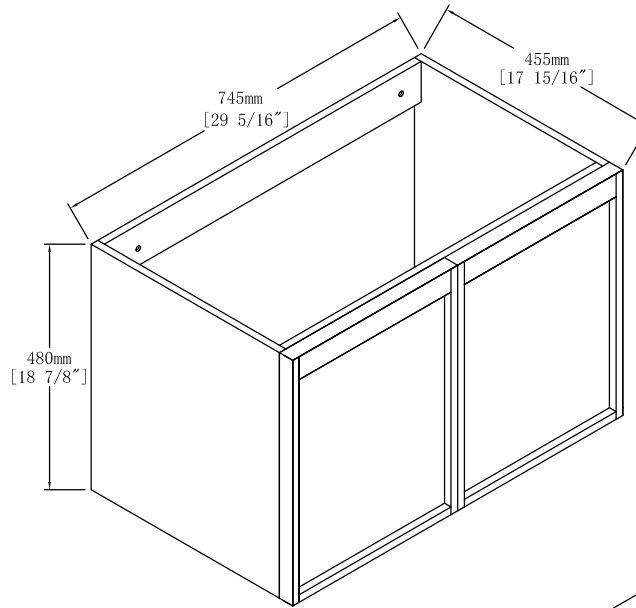
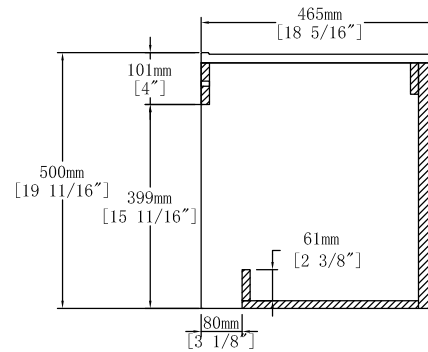

Side View

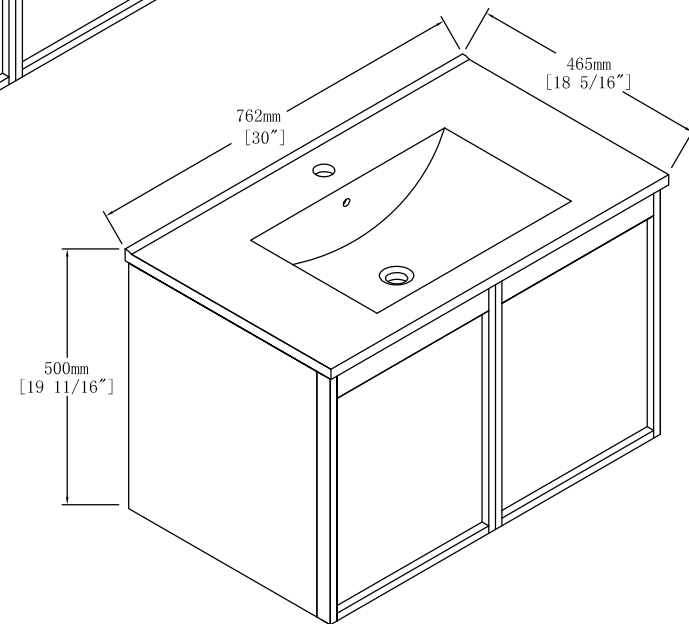

	Item NO.	UNOR VB 005 30	Version	V1
	Project		Date	2025-11-11