

OTO SP R55 UL

design Pio e Tito Toso 2015



 Vistosi



# ⚠ AVVERTENZE ! / WARNINGS !













Staccare l'interruttore generale di corrente prima del montaggio dell'apparecchio. Per l'installazione, in caso di dubbio interpellare un elettricista qualificato. Prima di iniziare consultare la lista componenti.

Turn off the main electricity switch before assembling. In case of doubts about the installation please contact a qualified electrician. Before starting, consult the components list.

 x2  180'

 **ATTREZZI / TOOLS**  

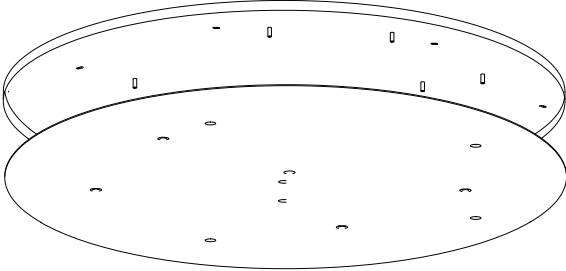
 **COMPONENTI / COMPONENTS**

X3	 <b>S</b> (Ø9CM)	X3	 <b>S</b> (Ø5,5CM)	X3	 <b>S</b> (Ø5,9CM)
X5	 <b>M</b> (Ø12CM)	X5	 <b>M</b> (Ø6,5CM)	X5	 <b>M</b> (Ø6,9CM)
X7	 <b>L</b> (Ø15CM)	X10	 <b>L</b> (Ø8,8CM)	X10	 <b>L</b> (Ø9,4CM)
X3	 <b>XL</b> (Ø18CM)				
X1				X9	
				X9	

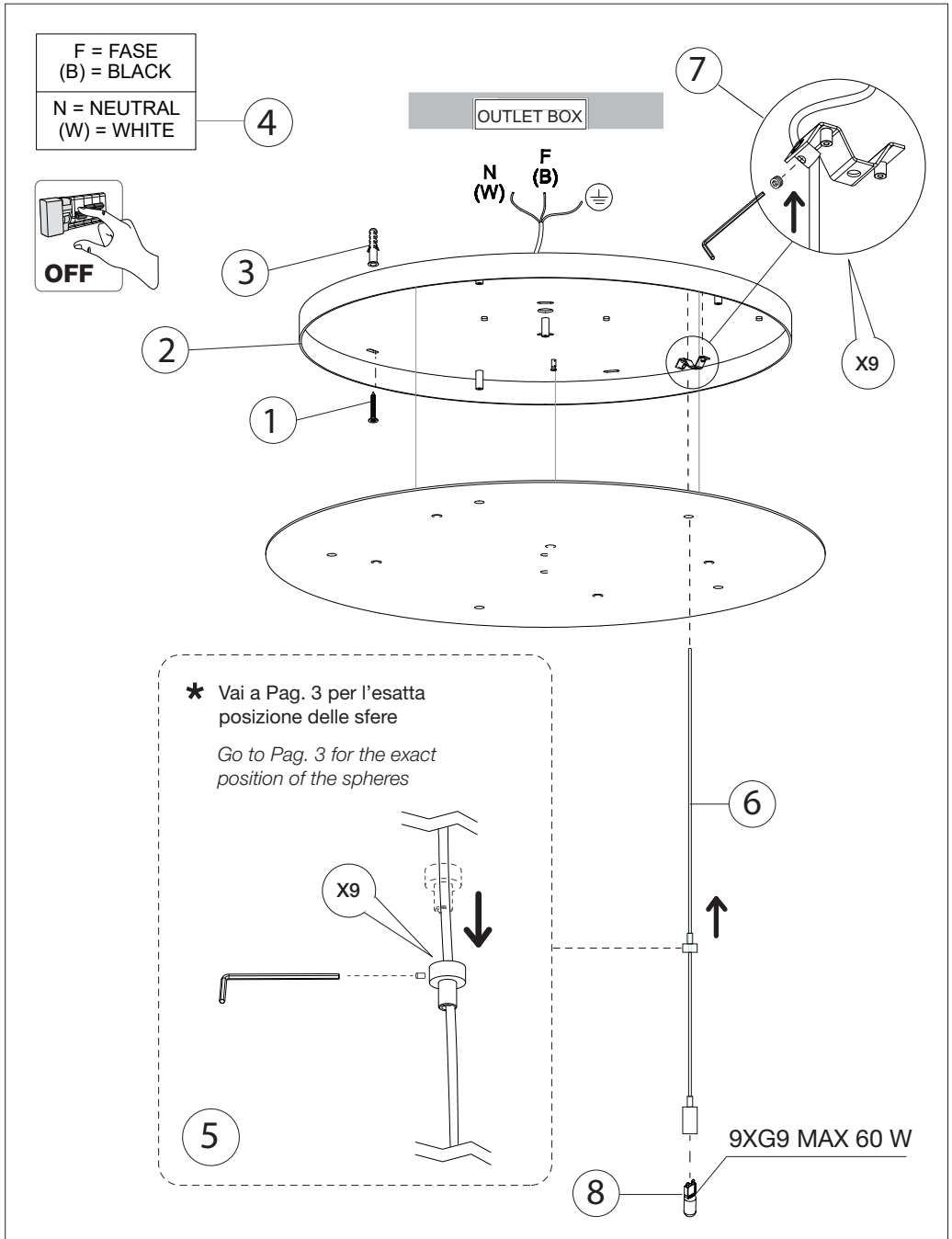

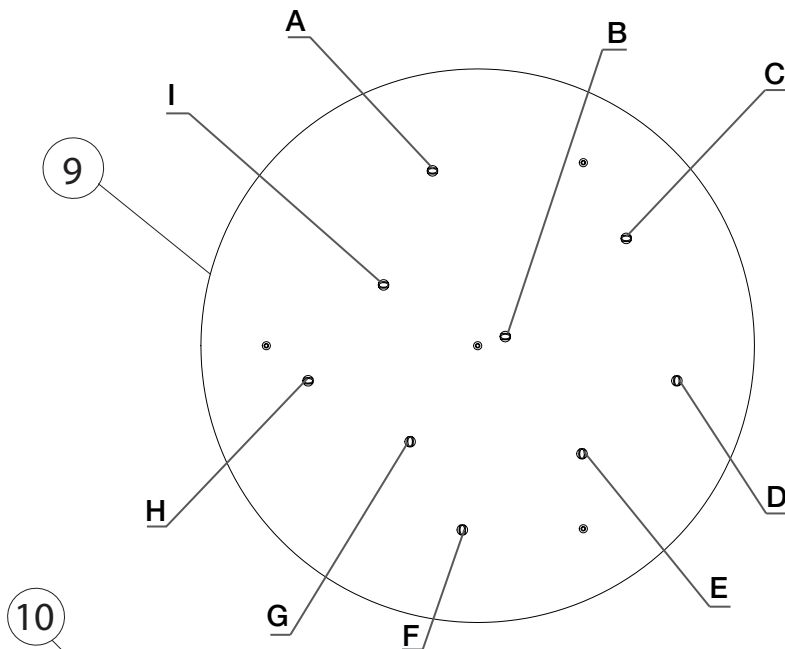

DISTRIBUZIONE CADUTE / DISTRIBUTION OF SPHERES

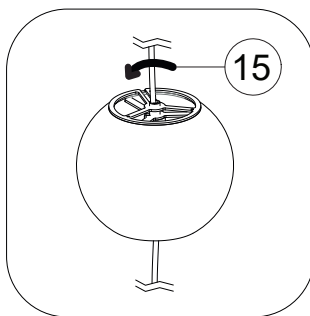
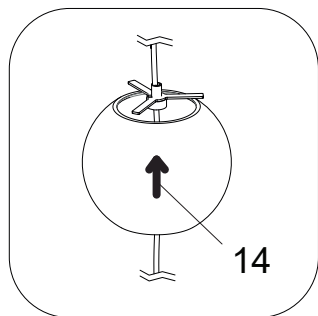
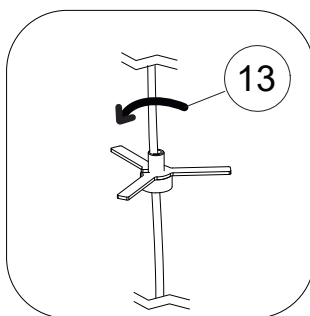
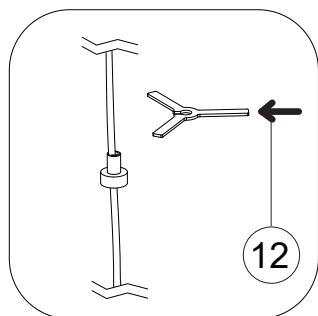
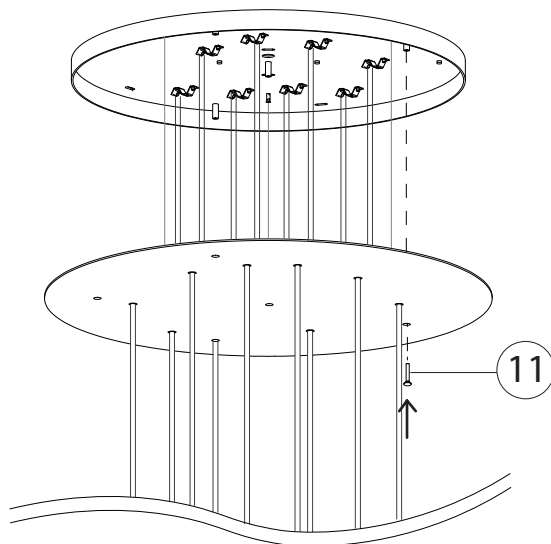

	A	B	C	D	E	F	G	H	I
<b>h</b>	37 + 28 cm	25 cm	18 + 44 + 30 + 22 cm	35 + 20 cm	74 + 25 cm	40 cm	13 cm	28 + 32 + 22 cm	108 + 18 cm
<b>∅</b>	15 cm 18 cm	15 cm	12 cm 9 cm 12 cm 15 cm	15 cm 12 cm	18 cm 15 cm	15 cm	12 cm	9 cm 15 cm 18 cm	9 cm 12 cm
	H TOT. 65 cm	H TOT. 25 cm	H TOT. 114 cm	H TOT. 55 cm	H TOT. 99 cm	H TOT. 40 cm	H TOT. 13 cm	H TOT. 82 cm	H TOT. 126 cm



 L'apparecchio di illuminazione rientra nella categoria di rifiuti RAEE.  
 Old appliances are waste electrical and electronic equipment (WEEE).

# IT - ISTRUZIONI DI MONTAGGIO, USO E MANUTENZIONE

## GENERALI

La garanzia del prodotto decade nel caso di errata installazione o manomissioni dell'apparecchio. Queste istruzioni di installazione, uso e manutenzione devono essere seguite attentamente e conservate assieme alla scheda di montaggio che viene fornita allegata alla presente. Per l'installazione in caso di dubbio interpellare un elettricista qualificato. Fare attenzione ai simboli e alle prescrizioni riportate sull'etichetta posta sul prodotto. Le istruzioni di montaggio aggiornate, si possono scaricare anche dal sito aziendale all'indirizzo [www.vistosi.it](http://www.vistosi.it) Non apportare modifiche all'apparecchio, se non autorizzate nelle istruzioni di montaggio. In caso di danneggiamento del cavo di alimentazione, per la sostituzione contattare l'assistenza o del personale qualificato. Non coprire l'apparecchio in alcun modo, né con tessuti né con altri materiali in quanto l'aerazione è fondamentale per il corretto funzionamento dello stesso. Tale precauzione vale anche come prevenzione antincendio.

## MANUTENZIONE

Si raccomanda di non toccare l'apparecchio in funzione in quanto alcune parti possono raggiungere temperature elevate. In caso di necessità, spegnere l'apparecchio ed attenderne il raffreddamento. Per la pulizia del vetro usare un panno umido senza solventi e/o abrasivi. Per la pulizia delle parti metalliche usare un panno morbido asciutto.

## MONTAGGIO / SMONTAGGIO

Togliere la spina dalla presa di corrente o staccare l'interruttore generale di corrente prima del montaggio o smontaggio dell'apparecchio, di qualsiasi suo componente o per la sostituzione delle lampadine. Non modificare o eliminare componenti che non siano stati indicati come optional nella scheda di montaggio. Durante il montaggio prestare la massima attenzione nel maneggiare le parti in vetro evitando in particolar modo urti che possono pregiudicarne l'integrità. Non stringere eccessivamente le viti di fissaggio dei vetri ed usare le relative guarnizioni in dotazione. Per gli apparecchi, che ne sono provvisti, usare le guaine di protezione dei cavi di alimentazione come indicato nella scheda di montaggio. Accertarsi che il voltaggio erogato dall'impianto elettrico sia corrispondente a quello indicato sull'apparecchio. Per lo smaltimento del prodotto vedere le avvertenze RAEE.

# EN - ASSEMBLY, USE AND MAINTENANCE INSTRUCTIONS

## GENERAL

The guarantee is not valid in the case of wrong installation or damage of the appliance. The following assembling, use, and maintenance instructions must be carefully followed and kept together with the assembling card attached to this page. In case of doubts about installation please contact a qualified electrician. Please follow the symbols and instructions written in the product's label. The updated assembling instructions can also be downloaded from the company's web-site [www.vistosi.com](http://www.vistosi.com). Do not modify the product in any way which is not contemplated in the assembling instructions. In case of damaged power cord please contact the assistance or a qualified electrician. Do not cover the appliance in any way (fabric nor any other material); a good ventilation is fundamental for its correct functioning. Such advice is also a valid fire preventing measure.

## MAINTENANCE

Please do not touch the functioning appliance; some of its parts may reach high temperatures. If needed, turn it off and wait until it cools down before touching it. Clean the glass with a wet cloth. Avoid solvents and/or abrasive substances. Clean the metallic parts with a dry soft cloth.

## ASSEMBLING / REMOVING

Unplug the appliance or turn off the main electricity switch before assembling or removing the appliance or any of its components or before changing the bulbs. Do not change or remove any component which is not indicated as optional in the assembling instructions. While assembling the appliance, be careful with the glass parts in order not to hit them in any way, compromising their integrity. Do not screw too hard the screws which fix the glasses and use the given seals. Use the protective sheaths (when given) for the electricity cables, as indicated in the assembling instructions. Check that the voltage produced by the electric system corresponds to that indicated on the appliance. For lamp's disposal please refer to RAEE indications.





Tensione Elettrica  
*Electrical Voltage*



Attenzione, pericolo!  
*Warning, danger!*



Spegnere l'interruttore  
Generale di Corrente  
*Turn off General  
Power Switch*



Messa a terra Elettrica  
*Grounding system*



Cavo Elettrico Neutro  
*Neutral Electric Wire*



Cavo Elettrico Linea  
*Line Electric Wire*



Persone Necessarie  
al Montaggio  
*People Needed for  
Assembly*



Tempo Stimato di  
Montaggio  
*Estimated Time of  
Assembly*



Sono Necessari  
Attrezzi Speciali  
*Necessary  
Special Tools*



Pre-assemblaggio su  
piano d'appoggio  
*Pre-assembly on  
a Support Surface*



Rifiuto Speciale RAEE  
*Special Waste WEEE*



Pulire accuratamente i  
componenti in vetro  
*Clean glass components  
carefully*



Effettua un controllo qualità  
dei componenti  
*Make a quality control  
of components*







Rev. 03 - Settembre 2022

Vetreria Vistosi srl - Via Galileo Galilei 9-9/A-11 - 31021 Mogliano Veneto - Treviso (Italy)  
Tel. +39 041 / 5903480 - [www.vistosi.it](http://www.vistosi.it) - [customer.service@vistosi.it](mailto:customer.service@vistosi.it)