

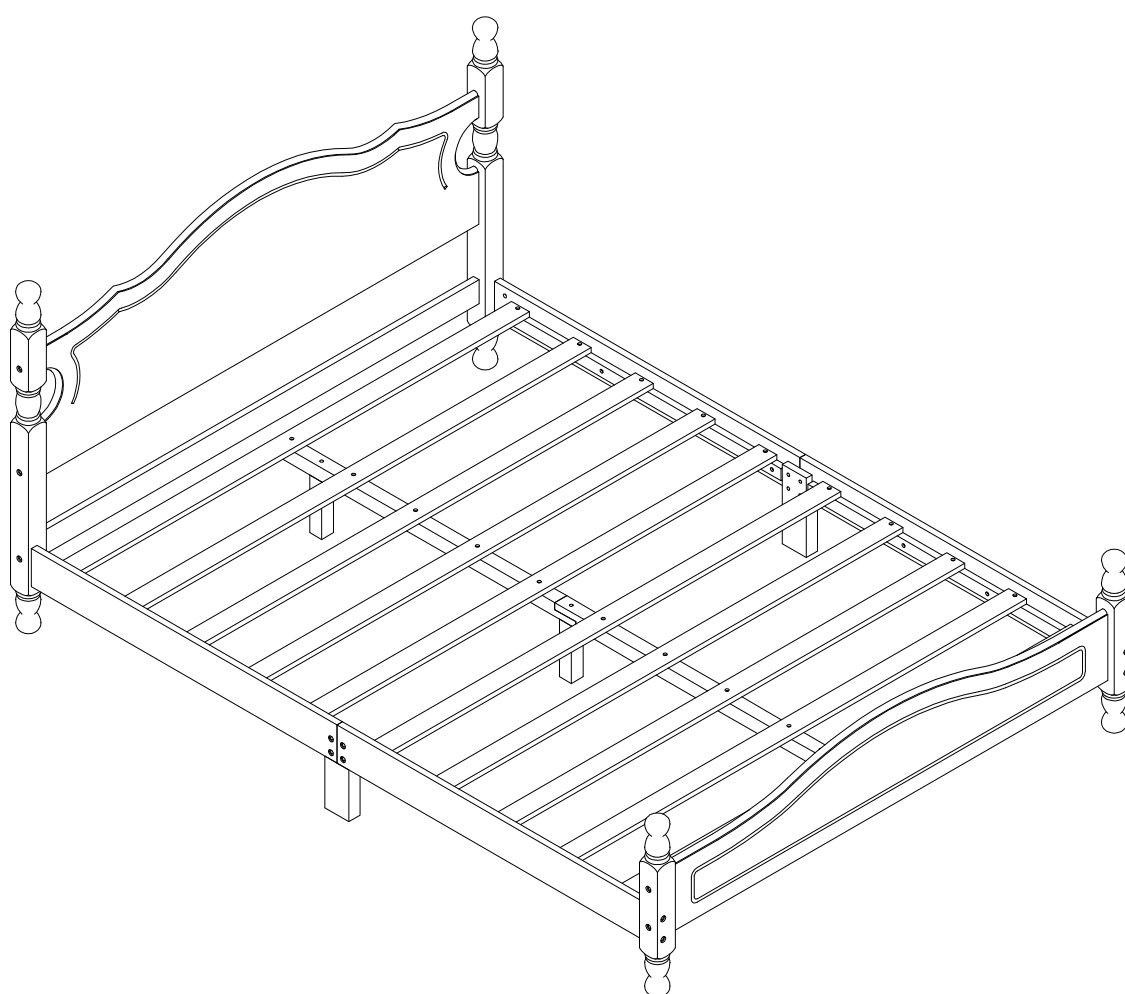

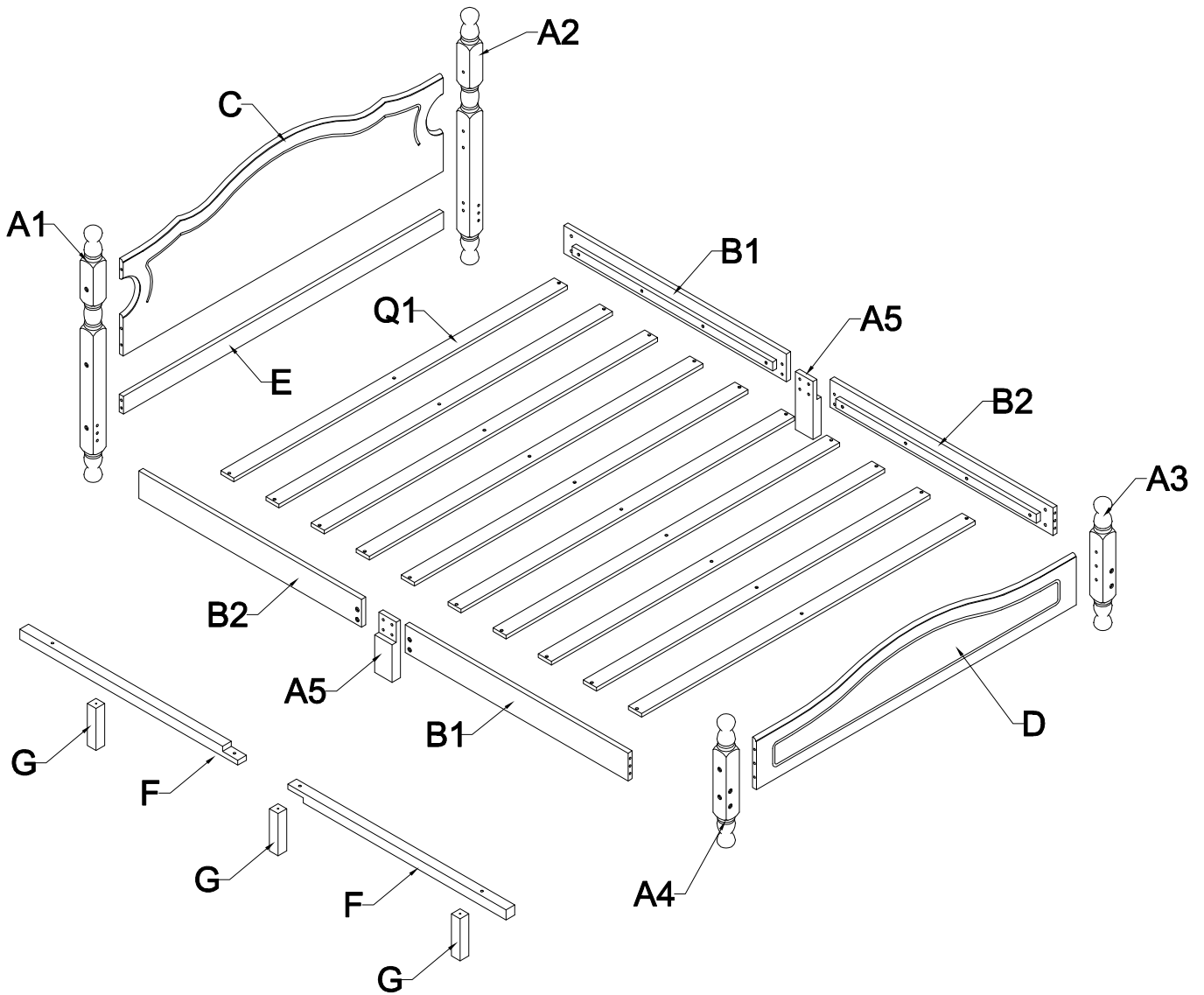



ASSEMBLY INSTRUCTIONS





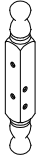
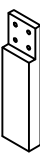
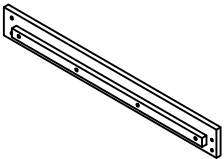
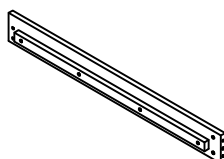
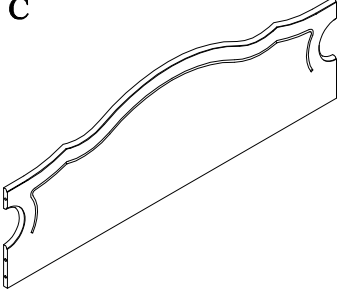
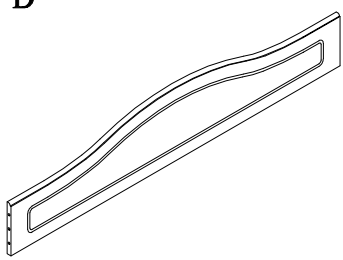
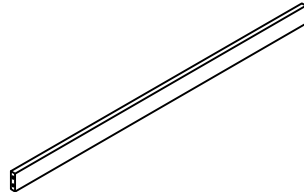
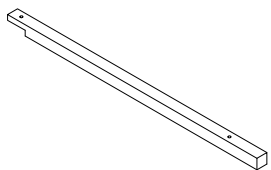

DETAIL VIEW

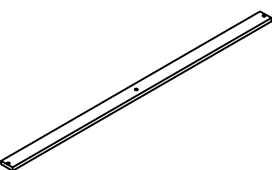

BOX 1

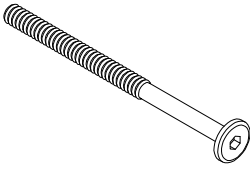
<p>A1</p>  <p>Front leg - left (1pc)</p>	<p>A2</p>  <p>Back leg - left (1pc)</p>	<p>A3</p>  <p>Back leg - right (1pc)</p>	<p>A4</p>  <p>Front leg - right (1pc)</p>
<p>A5</p>  <p>Middle leg (2pcs)</p>	<p>B1</p>  <p>Side rail - left (2pcs)</p>	<p>B2</p>  <p>Side rail - right (2pcs)</p>	<p>C</p>  <p>Headboard panel (1pc)</p>
<p>D</p>  <p>Footboard panel (1pc)</p>	<p>E</p>  <p>Horizontal rail (1pc)</p>	<p>F</p>  <p>Support slats (2pcs)</p>	<p>G</p>  <p>Extra leg (3pcs)</p>
<p>Q1</p>  <p>Slats (10pcs)</p>			

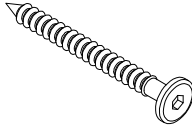

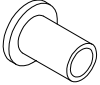
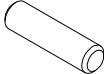
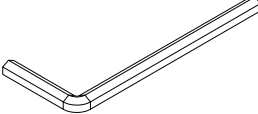
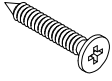
HARDWARE LIST

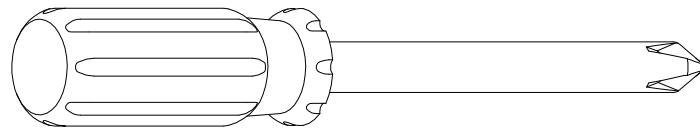
<p>1</p>  <p>Hex - Head bolts Ø1/4" * 110- 18pcs</p>	<p>2</p>  <p>Hex - Head bolts Ø1/4" * 30- 8pcs</p>	<p>3</p>  <p>Hexagonal bolts catch wood Ø6 * 70 - 3pcs</p>	<p>4</p>  <p>Horizontal - Hold bolts Ø1/4" - 18pcs</p>
<p>5</p>  <p>Canopy head though Ø1/4" - 8pcs</p>	<p>6</p>  <p>Wood dowel Ø8 * 30 - 10pcs</p>	<p>7</p>  <p>Allen key K4 - 2pcs</p>	<p>8</p>  <p>Wood crews M4 * 30 - 30pcs</p>





Assembly Tools Required (Not Included)

STEP 1

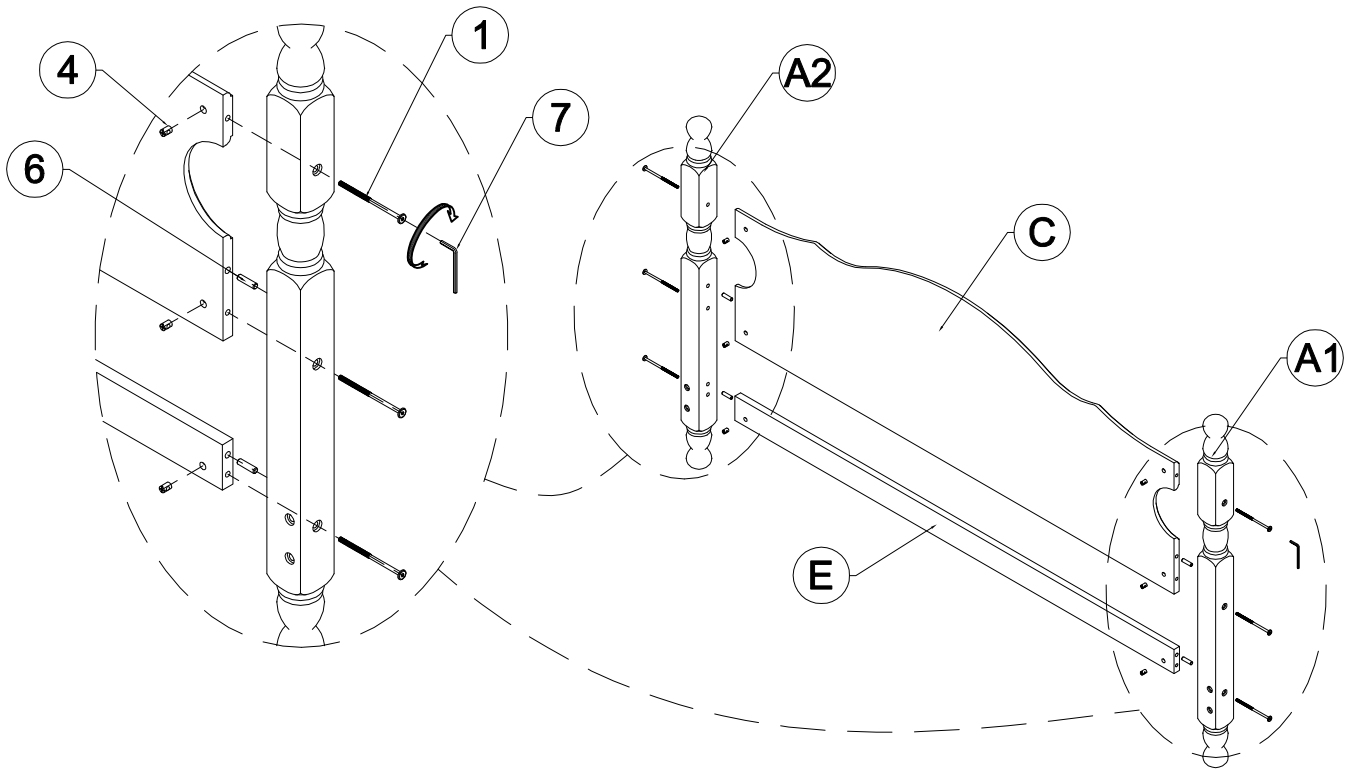
<p>1</p>  <p>Hex - Head bolts Ø1/4" * 110- 6pcs</p>	<p>4</p>  <p>Horizontal - Hold bolts Ø1/4" - 6pcs</p>	<p>6</p>  <p>Wood dowel Ø8 * 30 - 4pcs</p>
--	--	---



STEP 2

<p>1</p>  <p>Hex - Head bolts Ø1/4" * 110- 4pcs</p>	<p>4</p>  <p>Horizontal - Hold bolts Ø1/4" - 4pcs</p>	<p>6</p>  <p>Wood dowel Ø8 * 30 - 2pcs</p>
--	--	---

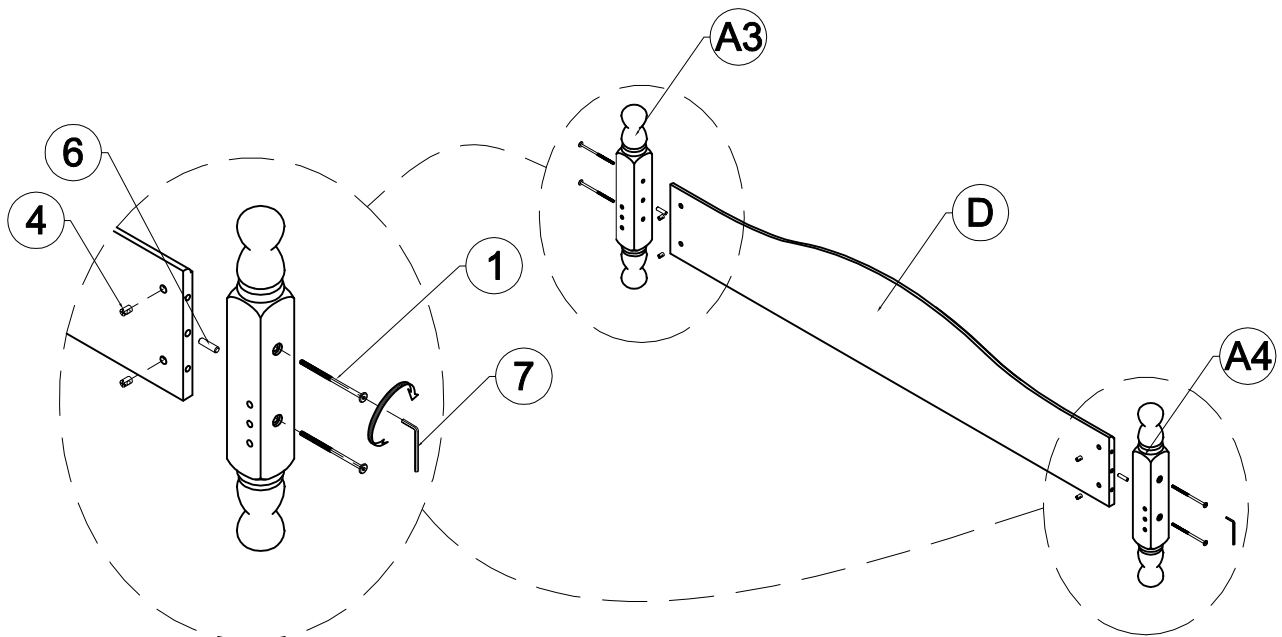

STEP 3

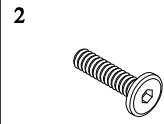

Hex - Head bolts
Ø1/4" * 30- 8pcs

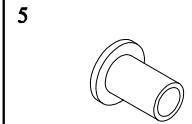

Canopy head though
Ø1/4" - 8pcs

X 2

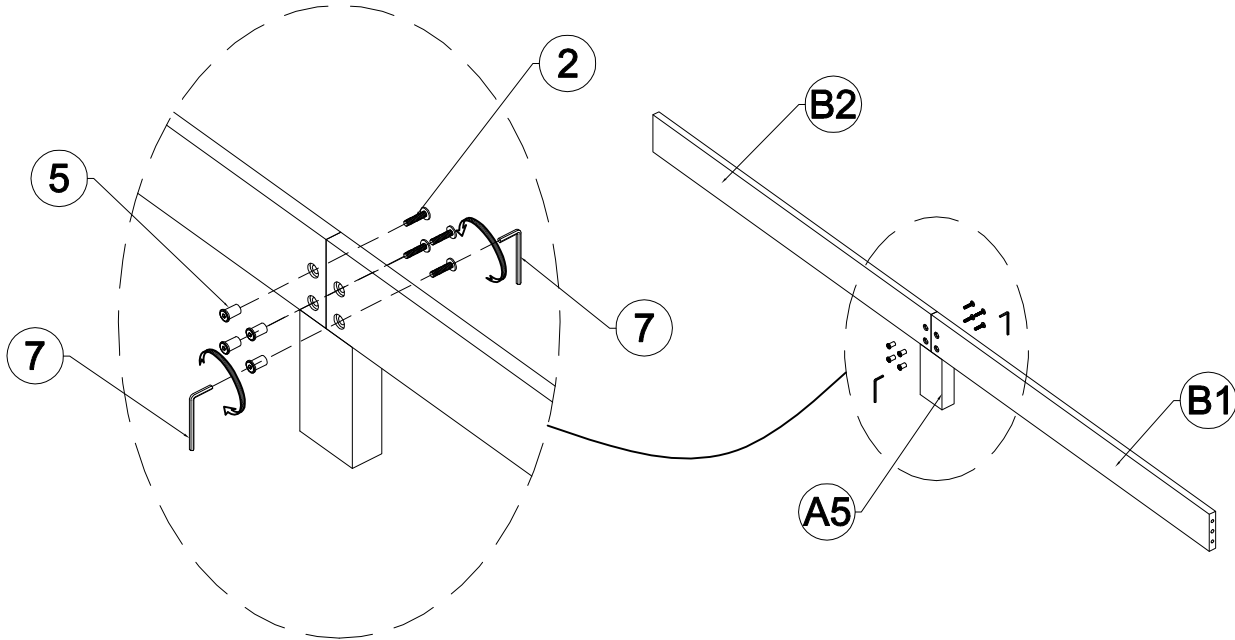

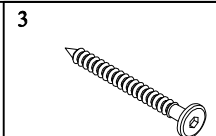

STEP 4

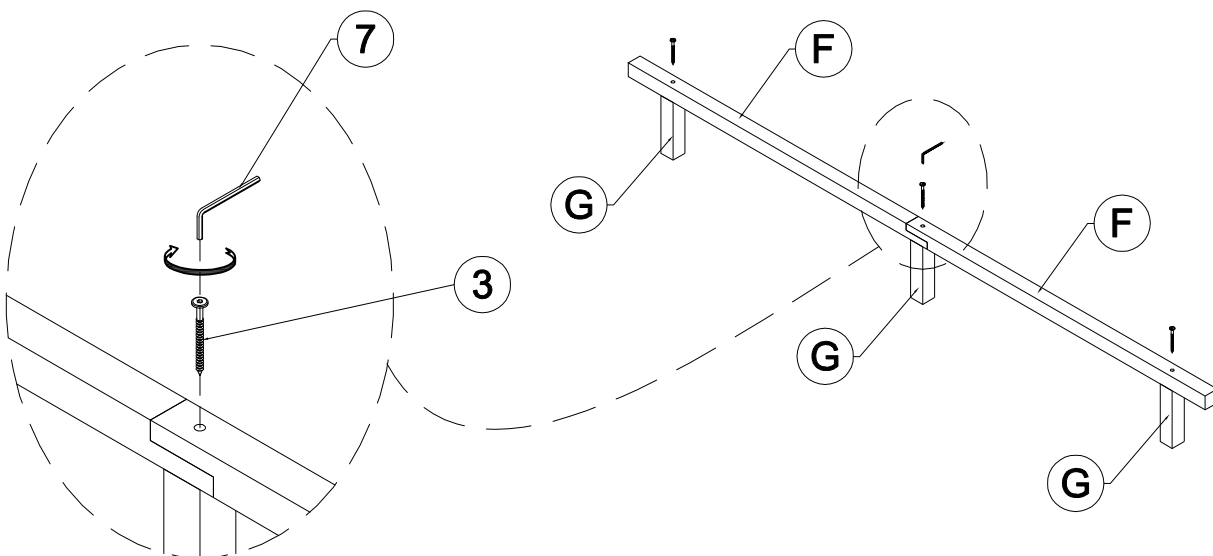

Hexagonal bolts catch wood
Ø6 * 70 - 3pcs



STEP 5

<p>1</p>  <p>Hex - Head bolts Ø1/4" * 110- 8pcs</p>	<p>4</p>  <p>Horizontal - Hold bolts Ø1/4" - 8pcs</p>	<p>6</p>  <p>Wood dowel Ø8 * 30 - 4pcs</p>
--	--	---

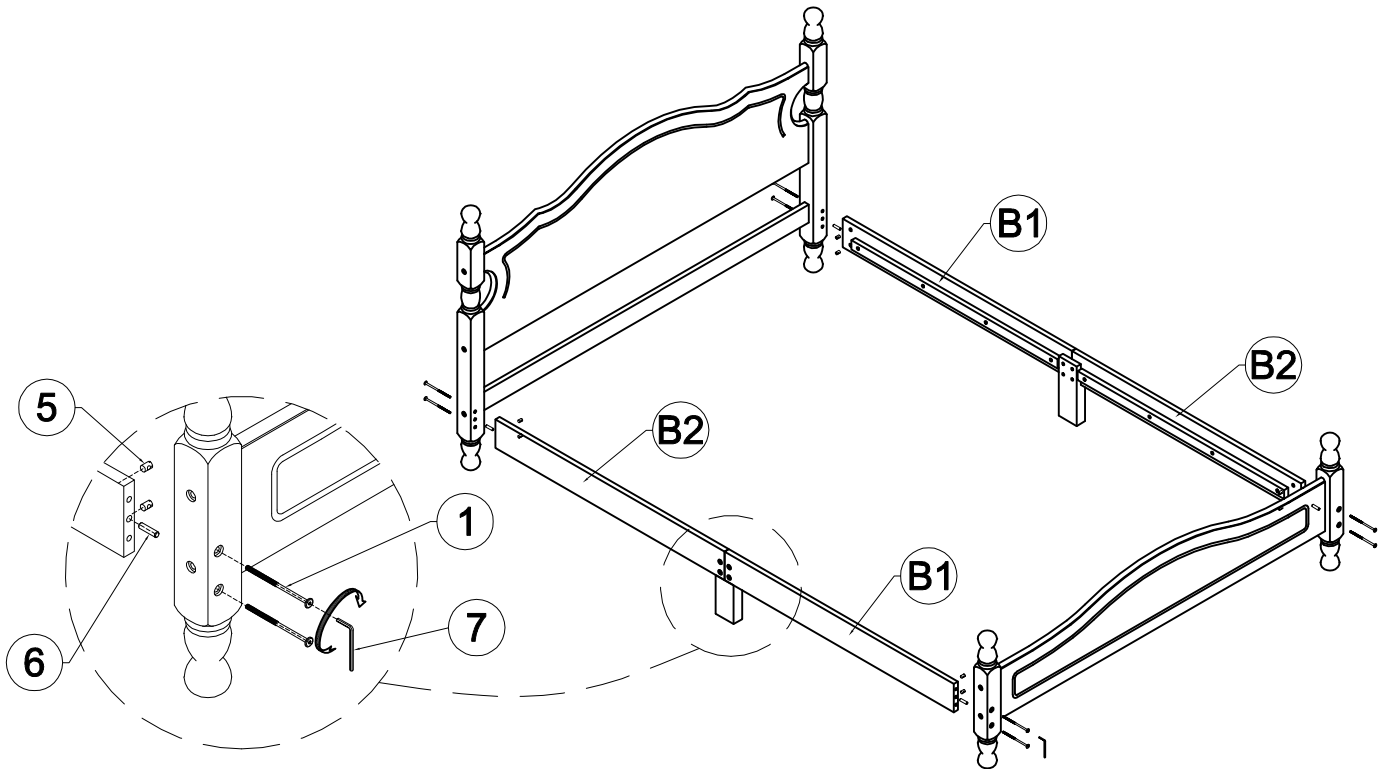

STEP 6

The distance between the slats is 5 - 3/4 inch

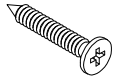
<p>8</p>  <p>Wood crews M4 * 30 - 30pcs</p>
--

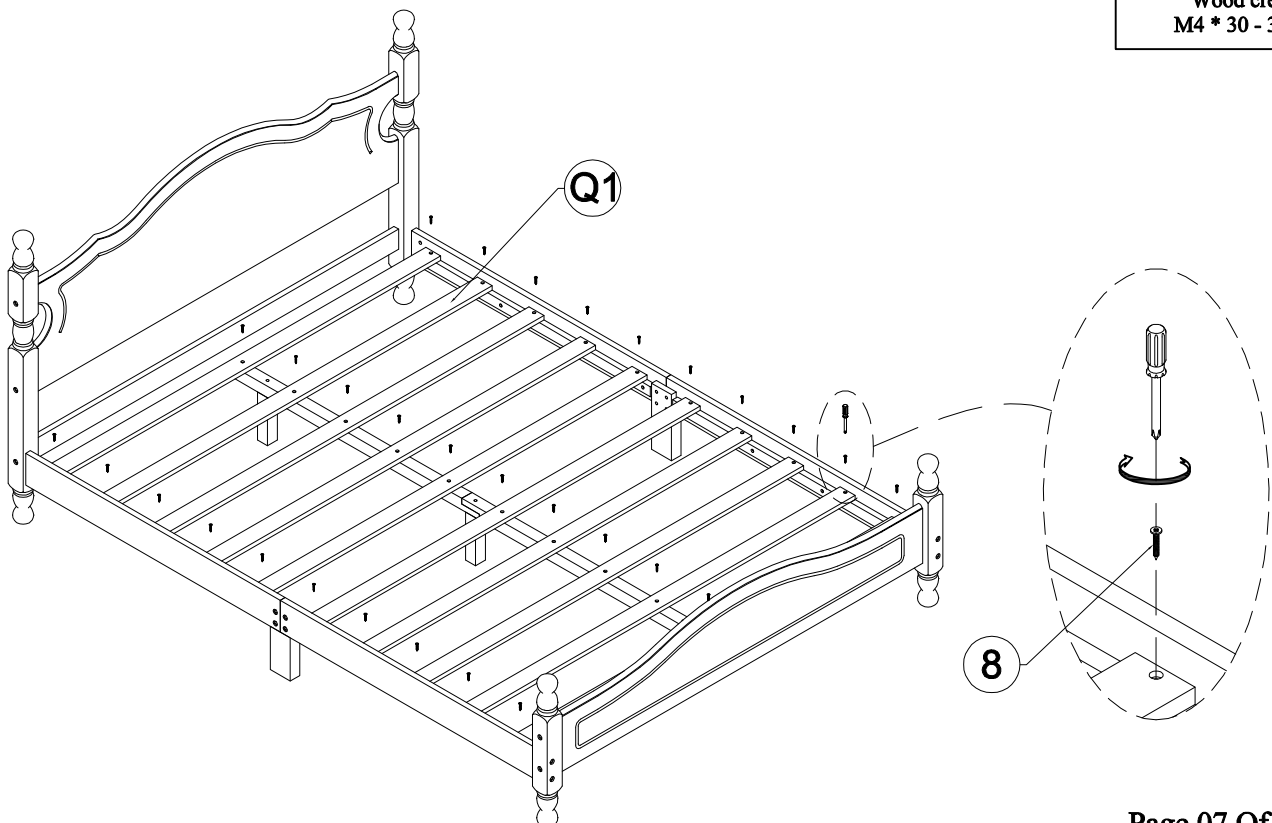

COMPLETED

