

Instruction Manual

WARNING

UNPACKING SAFELY

Please follow these instructions to unpack your garden building safely

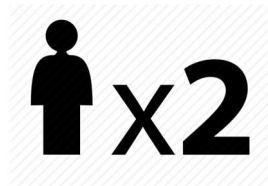

- Two people minimum to unpack
- Place the pallet on firm level ground
- Cut the plastic banding
- Remove each panel by removing screws one column at a time as indicated below
- Be careful of loose components inside the pack when removing panels
- Check all the components against the checklist prior to install

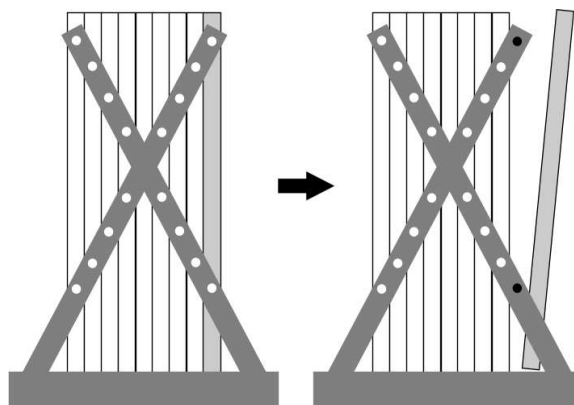

BASE KIT AND FIXING PACK

Please note – if you have ordered a base kit it's unlikely you will be able to see the base kit from the outside of the pack - it will be inside your panels. The fixings are also inside the pack.

Power Pent Product Instructions

Watch the video!

We recommend watching our installation video before starting assembly of your Power shed.
This video can be applied to all pent sheds in our range



www.Powersheds.com/faqs/how-do-you-assemble-a-power-shed/

Contents

- Page 3 – Before You Start
- Page 4 – Timber & Base Details
- Page 5-6 – Components Checklist
- Page 7 – Pre-Assembly
- Page 8 – Floor
- Page 9 – Door
- Page 10 – 11 – Walls
- Page 12 – Front Top & Gable
- Page 13 – Roof
- Page 14 – Felt
- Page 15 – Finishing Touches
- Page 16 – Aftercare & Maintenance
- Page 17 – Shed Shelving Instructions
- Page 18 – Two Tier Staging Instructions

Before You Start

Most accidents are the result of negligence and carelessness, usually caused by the failure of the operator to follow simple but necessary safety precautions.

Do **not** install the garden building before carefully reading this manual and ensuring all components are accounted for and have been checked for any damage.

Visit www.Powersheds.com to check the base size for your shed and any other dimensions you may need.

Health & Safety

Every effort has been made during the manufacturing process to eliminate splinters on the timber.

You are strongly advised to wear gloves when working with or handling timber.

We also strongly advise you to wear safety glasses when installing the felt to protect your eyes.

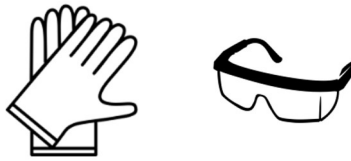

2 persons recommended



Power Sheds Ltd cannot be held responsible for any damage or injury sustained due to incorrect unloading, unpacking, or assembly of any of our products.

Tools required

(not supplied)



Drill



Spirit level



Hammer



Stanley knife



Stepladder



Saw

Our treatment

Wear gloves when handling freshly treated wood.

Avoid breathing dust when cutting treated or untreated wood. Dispose of off-cuts responsibly – do not burn.

Contains: IPBC (3-iodo-2-propynyl-N-butyl carbamate) and propiconazole.

May produce an allergic reaction (EUH208). Causes serious eye irritation (H319) Wash skin thoroughly after handling (P264)

Wear protective gloves/protective clothing/eye protection/face protection (P280)

IF IN EYES: Rinse cautiously with water for several minutes.

Remove contact lenses, if present and easy to do and continue rinsing. (P305 + P351 + P338)

If eye irritation persists: Get medical advice/attention (P337+P313)

Timber

As timber is a natural product, it is prone to changes in appearance, including some movement, warping and splitting, particularly in extreme weather conditions. There may be the occasional split, knot or similar visual imperfections in the timber.

Whilst every effort is made to hand pick timber without visible knotholes or splits there may be occasions where timber is selected in good faith that contains what appears to be a solid knot which over the course of time / during movement of the product it may occur that these small knot holes are then dislodged from the timber leaving a small knot or crack.

Unfortunately, we cannot be held responsible for this maturing of the product and can only offer our best advice as how to deal with this situation in the unlikely event that it should occur which would be to apply some wood filler to the area affected or in extreme circumstances to change the board over.

None of this should affect the structural integrity of the product.

Firm & Level Base

All our garden sheds require a firm and level base.

When thinking about where the garden building and base is going to be constructed:

- Ensure that there will be access to all sides for maintenance work and annual treatment.
- Remember not to place the base too close to any walls or fences, as there may be a slight overhang on the roof which may come into contact with the wall or fence.
- Ensure the base is level and is built on firm ground, to prevent distortion.
- Refer to PowerSheds.com for base dimensions.
- Consider when placing the base next to trees or large bushes as this could cause problems from overhanging branches, especially if these are likely to grow and come into contact with the building in the future and could cause the felt to rip.

The base is slightly smaller than the external measurement of the building, i.e. The cladding should overhang the base, creating a run for water.

It is recommended that the floor is at least 25mm above the surrounding ground level to avoid flooding.

If you have not chosen to purchase our Power Base, then other suitable bases would include a concrete base (75mm of concrete on top of 75mm of hardcore) or a paving slab base (slabs laid on top of 50mm of sharp sand).

Power Base Kit













If you have ordered a Power Base Kit the instructions can be found in the small base kit fixing pack.

Please scan the QR code to watch our base kit installation video -

Watch the build a base video:













www.powersheds.com/faqs/how-do-you-assemble-the-power-sheds-base-kit/

	4x4 Floor	2x4 Floor	4x6 Floor	2x6 Floor	4ft Blank Panel	4ft Window Panel (Or additional blank panels if windowless)	2ft Blank Panel	Door Panel (Single or Double)	4x4 Pent Roof Panel (For 4ft wide)	2x4 Pent Roof Panel (For 4ft wide)	4x6 Pent Roof Panel (For 6ft wide)	2x6 Pent Roof Panel (For 6ft wide)	4ft Pent Gable Top	6ft Pent Gable Top	
															
	4x4	1	0	0	0	2	1	0	1	1	0	0	0	2	0
**	6x4	1	1	0	0	2	1	2	1	1	0	0	0	2	0
	8x4	2	0	0	0	3	2	0	1	2	0	0	0	2	0
	10x4	2	1	0	0	3	2	2	1	2	1	0	0	2	0
	12x4	3	0	0	0	4	3	0	1	3	0	0	0	2	0
	14x4	3	1	0	0	4	3	2	1	3	1	0	0	2	0
	16x4	4	0	0	0	5	4	0	1	4	0	0	0	2	0
	18x4	4	1	0	0	5	4	2	1	4	1	0	0	2	0
	20x4	5	0	0	0	6	5	0	1	5	0	0	0	2	0
**	4x6	0	0	1	0	2	1	2	1	0	0	1	0	0	2
	6x6	0	0	1	1	2	1	4	1	0	0	1	1	0	2
	8x6	0	0	2	0	3	2	2	1	0	0	2	0	0	2
	10x6	0	0	2	1	3	2	4	1	0	0	2	1	0	2
	12x6	0	0	3	0	4	3	2	1	0	0	3	0	0	2
	14x6	0	0	3	1	4	3	4	1	0	0	3	1	0	2
	16x6	0	0	4	0	5	4	2	1	0	0	4	0	0	2
	18x6	0	0	4	1	5	4	4	1	0	0	4	1	0	2
	20x6	0	0	5	0	6	5	2	1	0	0	5	0	0	2

Component Checklist

Please note – If you have a **Potting Shed**, the number of 4ft window panels will be the same, but there will also be two or three 2ft window panels (depending on the size) instead of two or three 2ft blank panels. You will also receive shelving which will be fitted under the window and screwed with 50mm screws. There will be legs for the front of the shelving and the back of the shelving is screwed to the upright framing of the wall.

** Please take additional care when checking components for a 4x6 and 6x4 shed as these are 2 different sheds with different components.

	1790x56 x44mm Heavy Duty Bearer	1190x56 x44mm Heavy Duty Bearer	4ft Front Top	2ft Front Top	1363x70mm Bargeboard (For 4ft)	1963x70mm Bargeboard (For 6ft)	1801 x58mm Cover Lat	1925 x58mm Cover Lat	Felt	Fixing Pack
										
4x4	0	2	1	0	5	0	2	2	8ft Piece @ 1m wide	1
6x4	0	2	1	1	2	3	3	3	12ft Piece @ 1m wide	1
8x4	0	2	2	0	8	0	3	3	16ft Piece @ 1m wide	1
10x4	0	2	2	1	5	3	4	4	20ft Piece @ 1m wide	1
12x4	0	2	3	0	2	6	4	4	24ft Piece @ 1m wide	1
14x4	0	2	3	1	8	3	5	5	(2x) 14ft Piece @ 1m Wide	1
16x4	0	2	4	0	5	6	5	5	(2x) 16ft Piece @ 1m wide	1
18x4	0	2	4	1	2	9	6	6	(2x) 18ft Piece @ 1m wide	1
20x4	0	2	5	0	8	6	6	6	(2x) 20ft Piece @ 1m wide	1
4x6	2	0	1	0	3	2	4	2	8ft Piece @ 1m wide 4ft Piece @ 0.5m wide	1
6x6	2	0	1	1	0	5	5	3	12ft Piece @ 1m wide 6ft Piece @ 0.5m wide	1
8x6	2	0	2	0	6	2	5	3	16ft Piece @ 1m wide 8ft Piece @ 0.5m wide	1
10x6	2	0	2	1	3	5	6	4	20ft Piece @ 1m wide 10ft Piece @ 0.5m wide	1
12x6	2	0	3	0	0	8	6	4	24ft Piece @ 1m wide 12ft Piece @ 0.5m wide	1
14x6	2	0	3	1	6	5	7	5	(2x) 14ft Piece @ 1m Wide 14ft Piece @ 0.5m wide	1
16x6	2	0	4	0	3	8	7	5	(2x) 16ft Piece @ 1m Wide 16ft Piece @ 0.5m wide	1
18x6	2	0	4	1	0	11	8	6	(2x) 18ft Piece @ 1m Wide 18ft Piece @ 0.5m wide	1
20x6	2	0	5	0	6	8	8	6	(2x) 20ft Piece @ 1m Wide 20ft Piece @ 0.5m wide	1

7x5 Sheds

If you have ordered a 7x5 Pent Shed, you will receive:

Panels – (1x) 3ft door panel, (1x) 4ft window panel (or additional blank panel), (1x) 4ft blank panel, (3x) 3ft blank panels, (2x) 2ft blank panels, (1x) 4x5 floor panel, (1x) 3x5 floor panel, (1x) 3x5 roof panel, (1x) 4x5 roof panel.

Components – (2x) 5ft gable tops, (1x) 4ft front top, (1x) 3ft front top, (2x) 5ft heavy duty bearers, (3x) 1925x58mm cover lats, (5x) 1801x58mm cover lats, (2x) 1663x70mm bargeboards, (3x) 1363x70mm bargeboards, (3x) 1063x70mm bargeboards, 14ft piece of felt & 7ft piece of felt @ 0.5m wide, fixing pack.

The Fixing Pack

Your fixing pack will include:

- 25mm screws (silver)
- 35mm screws
- 50mm screws
- 70mm screws
- Clout nails (for the felt)
- 40mm galvanised nails

If you have ordered a Power Base, you will also receive 80mm and 100mm screws.

*Please note 35mm screws are not needed for a pent
(This is a standard pack used for both pent and apex sheds)*

On the rare occasion that not enough screws are provided please contact us and make us aware so we can send more out to yourself. Please be aware we are unable to reimburse if you purchase your own.

Pre-Assembly

1. Safely unpack your components and check that you have all the parts required.
Please use the table in the two previous few pages to view which components are required for the size you have ordered.
2. Carefully remove the pallet and any untreated packing timber.
3. Remove any transport blocks from the bottom of the blank and window panels. These are there to offer further protection to the bottom board of the panel.

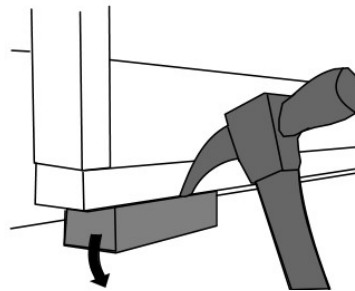

USEFUL TIP!

Re-treat the underside of the floor before assembly for additional protection and maximum longevity.

Drilling

In the instructions we will talk about screwing panels together. We recommend this is done with a drill. We suggest that you pre-drill the timber with a 3mm drill bit before inserting the screws. This will minimise the chance the timber will split.

Floor

1. Lay down your floor panel(s) onto your firm and level base into the desired position of your shed. Be sure to consider any overhangs on the shed when deciding the correct position as per the instructions regarding bases in the 'before you start' section.

**NOTE: Do not confuse floor panels with roof panels.
Floor panels will have more pieces of framing attached.**

2. Turn the floor sections upside down so that the floor bearers are facing up and the floor boards are running in line with each other. Join the floor panels together using the 50mm screws provided, using around three screws per join.
3. At this stage, screw the two 'heavy duty bearers' which are two pieces of framing joined together, to each gable end (the end where the triangular 'gable tops' will go later' – especially important on 4x4 and 6x6 sheds where the bearers could accidentally be put on the wrong side).
4. Join the bearers by screwing through the floor joists first so the screw goes as far into the bearer as possible.
 - a. For 4ft wide Power sheds (4x4, 6x4, 8x4, 10x4, 12x4, 14x4, 16x4, 18x4, 20x4) use the 1190mm heavy duty bearer provided.
 - b. For 5ft wide Power Sheds (7x5) use the 1490mm heavy duty bearers provided.
 - c. For 6ft wide Power sheds (4x6, 6x6, 8x6, 10x6, 12x6, 14x6, 16x6, 18x6, 20x6) use the 1790mm heavy duty bearer provided.
5. Once screwed together, turn the floor the correct way up.

Note – The method of turning the floor over is suitable for sheds up to 12ft long.

If the shed is over 12ft long, then you may struggle to turn the whole floor over without damaging the floor. For floors over 12ft long this method should be followed but to do it in two halves.

USEFUL TIP! – If you have purchased a **POWER Base** you can screw the floor to the timber **POWER base** below for maximum strength and security.

Reminder

Ensure bearers are added to the floor!

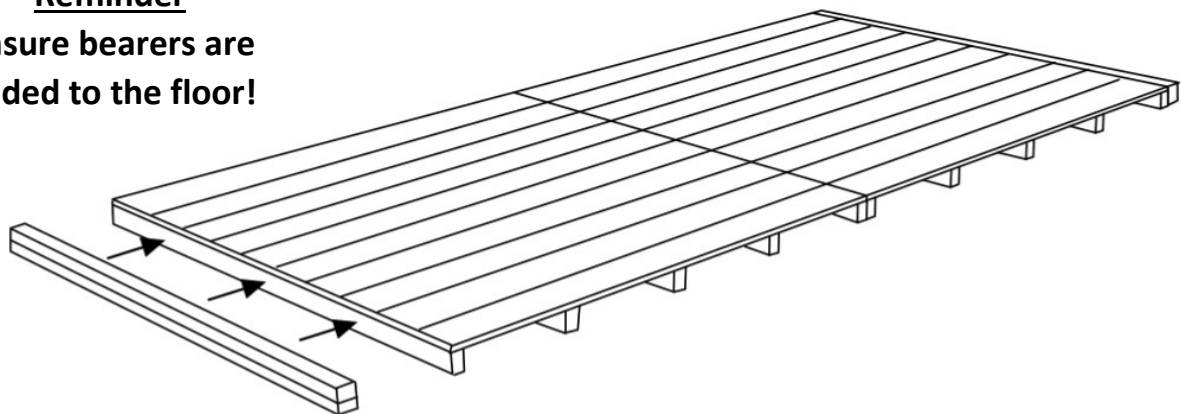

(image showing two heavy duty bearers being attached to each end of the floor)

Door

1. Your shed will either come with a single door or a double door depending on what you selected when ordering. Double doors are already hung on the door panel. However, for a single door you will need to hang the door. The key is screwed to the back of the door.

For a single door you can choose which way round to hang it – left hand or right hand.

Note – If you choose a left-hand hinged door then the lock can be unscrewed and positioned the other way round as it will be upside down. You may need to drill new holes for this to be fitted correctly.

2. For a single door, lay the door panel on the floor and. Line up the door onto the framing so that it is square. The door should be positioned centrally, with an even gap on both sides. Make sure the lock is on the inside of the shed when the door is closed. Secure the hinges in place using the 25mm screws provided.
3. Choose two places on the door to secure your two turn buttons – one towards the top, one towards the bottom. For double doors a turn button will already be secured. Be careful not to screw this too tightly or it will not turn.

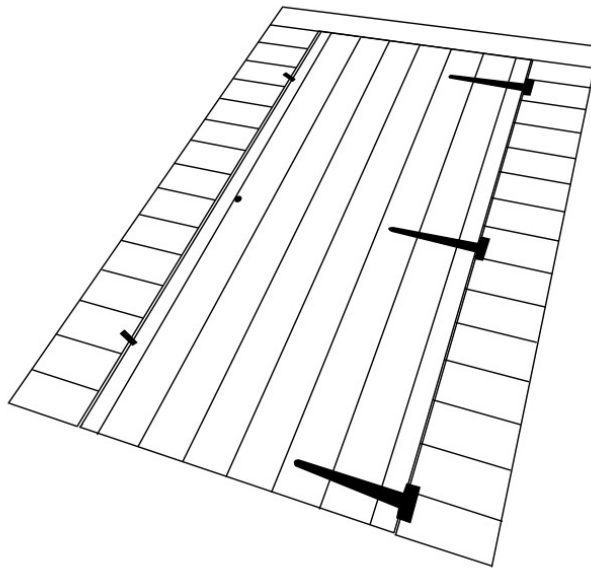

Important!

Make sure the door is unlocked before the next stage or once you have assembled the side walls you will not be able to get in your shed.

Walls

1. Please ensure you have removed the transport blocks as per page 7.
2. Your shed will come with a number of wall sections. The quantity of these will depend which type and size you ordered – there could be 4ft Blank Panels, 2ft Blank Panels, 4ft Window Panels (unless you have selected the windowless version), 3ft sections (for a 7x5 shed) and a door panel (which could be a single door or double door). Please see the components table to confirm which panels you should have for your shed.
3. Lay out the wall panels in the configuration you want for your garden building.
The blank panels, door panel and window panels can go in any position.

We give you the ‘power’ to choose how you want your shed!

4. Start with the 4ft panel (or 3ft panel for a 7x5) that will be part of your gable end (the end where the triangular gable tops will go later) and position this on top of one of the heavy duty bearers which you attached in the previous section. Ensure the side of the panel is flush with the side of the floor.
5. If your Power shed is 5ft or 6ft wide (4x6, 6x6, 7x5, 8x6, 10x6, 12x6, 14x6, 16x6, 18x6, 20x6) then you will need to position one of the 2ft blank panels next to the 4ft (or 3ft for the 7x5) wall panel you have chosen to complete the gable end.
6. Secure these panels together from the inside using the 50mm screws provided. Use three screws per join.

Important!

When securing panels together ensure they line up at the top (so the building is square) and that only the ends of the cladding are shown, which will later be covered with corner strips).

This is only in the corner when the side meets the gable.

7. Place another wall panel at a right angle to the gable end wall panels for the side walls and again secure using the 50mm screws provided.

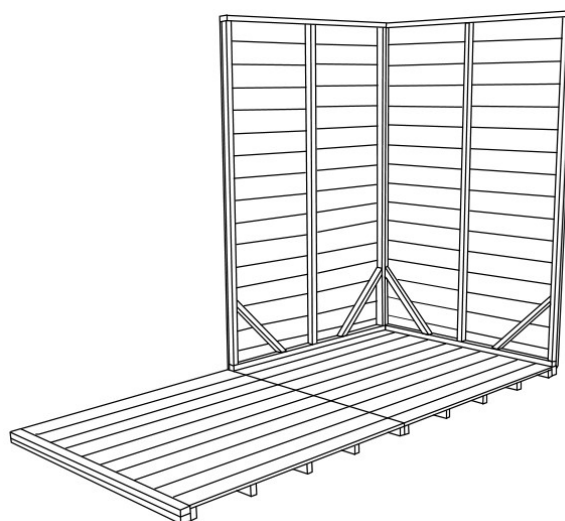

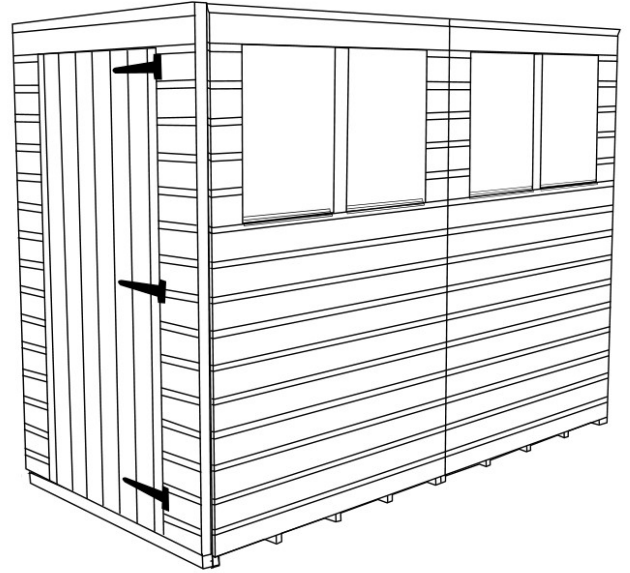
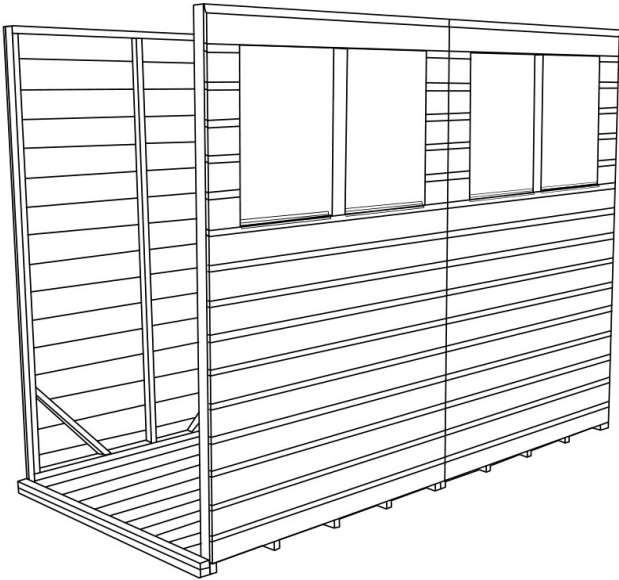

7. When you have secured all the wall panels (door panel, 2ft, 3ft and 4ft blank panels, window panels) you then need to secure these to the floor using 70mm screws provided. Screw into the floor with 2x screws for every wall panel ensuring the screws are driven through the framing at the bottom of the side/gable walls, through the floor boards and into the floor joists.

USEFUL TIP!

You can work out the position of the floor joists from the location of the existing nails in the floor. If the upright framing or corner brace is in the way you would need to nail down into the floor joists at an angle.

If you are securing these panels against a wall (which gives you little access to nail the cover strips on, explained later) you can pre-assemble a side and move the whole side into position (with the cover lats already nailed on)

Front Top & Gables

1. Add the pent front top to the side you want to be higher and screw to the panels below with 50mm screws.

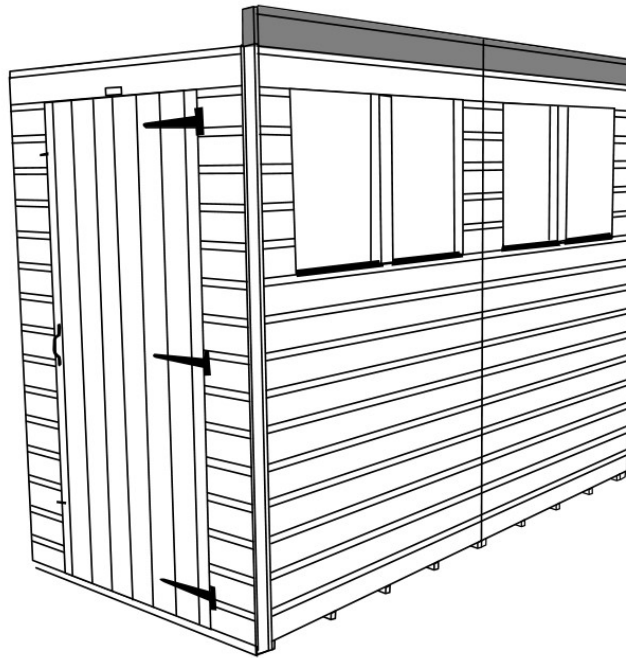

2. Line up the gable tops with the panels at the gable ends (the ends where you attached the 'heavy duty bearers' and secure them to the wall panels with 50mm screws from the inside, screwing upwards through the framing.

Please ensure that the 4ft pent top is on top of the 4ft panel and any 2ft pent tops are placed up on the 2ft panels as this will ensure that the cover lats align.

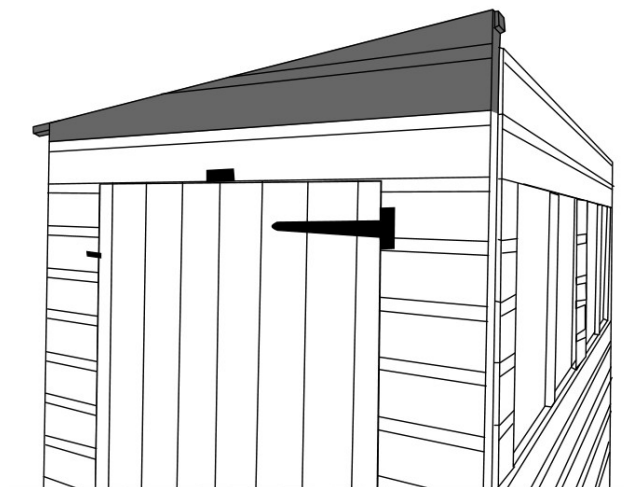

Roof

1. Depending on the size building you have ordered, your roof panels will be 2ft wide or 4ft wide. Place the roof panels in place so that the framing on the roof panel runs parallel with the gables i.e. from the front high side to the back low side.

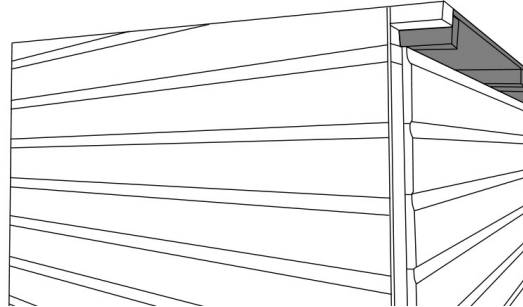

Make sure the framing on the roof is in line with the framing on the gable top so that the overhang on the front and back is correct.

If the framing does not align the base may be very slight out and the two opposite corners of the floor may need lifted. More details on bases can be found on www.powersheds.com/how-to-build-a-shed-base/

2. Join the roof panels to each other and to the gables using 50mm screws, going through the framing from the inside of the building.
3. Then, screw the roof panels to the side wall panels with 50mm screws (ensuring you screw up through the framing from the inside of the building into the framing on the roof panels).

Note – The roof panels are not handed, it does not matter which way round they go.

Felt

Health and Safety – Use safety goggles when installing the roofing felt.



1. Before laying the felt, you will need to attach the back bargeboards (which are 70mm wide) with the 40mm galvanised nails.

These bargeboards may come in more than one section and may need cutting down to size with a saw, depending on which size shed you have chosen.

Be sure not to mix these up with the corner strips and cover lats which are to go vertically around the shed in corners and covering joins (explained later).

Tip!

The underside bargeboard can left off to allow for additional ventilation in your shed.

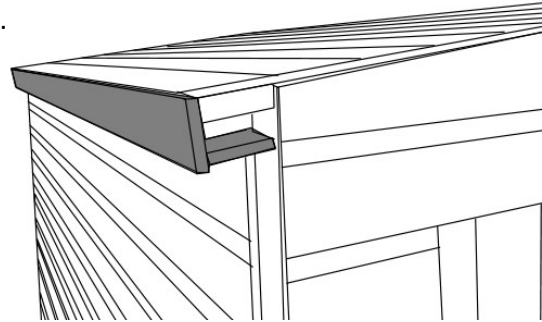

2. Roll out the mineral roofing felt along the lower part of one side of the roof. Allow for sufficient overhang to fold down onto the roof bargeboard (but not the underside roof bargeboard).

Health and Safety – Use Step Ladders to put on the roof felt but do not climb on top of the roof. Ensure there is a second person to support you when using a ladder.

Note – If you are unsure on how to felt the roof please contact us directly for more information. Please be aware, we cannot reimburse you if you choose to purchase additional materials

3. Use clout nails to tack along the top edge of the felt and into the roof board and the bottom edge of the felt into the back bargeboard.
4. Repeat this process along the higher part of the roof.

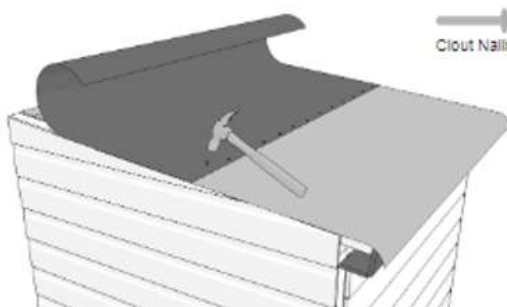

Important!

Take care not to tack into the tongue and groove join between each board as this can cause leaks.

Fold down the overhanging felt on the gable ends and tack this into place. Front and side bargeboards will cover any untidy edges.

Finishing Touches

1. Using the 40mm galvanised nails, fit the bargeboards to the front and sides of the roof. Again, these may need cutting down with a saw depending on what size building you have.

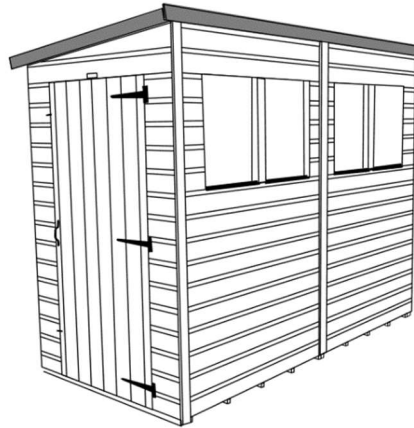

2. Secure corner strips at each corner of your Power shed with 40mm nails (at least four per strip). Extra strips are provided to cover any joins between side wall panels.

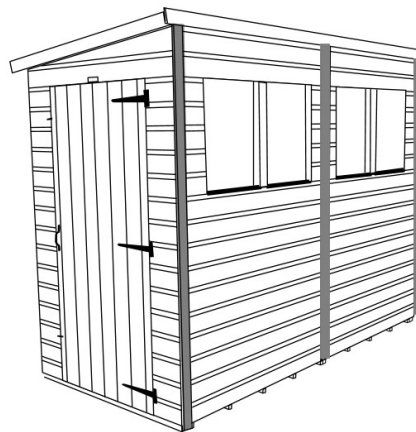

3. Secure the door pull to the door with 25mm screws.
4. Ensure there are no overhanging branches or debris on the shed as this can lead to water ingress. Please be aware, this will need to be checked regularly as part of the maintenance of the shed.
5. Peel the protective sticker off the Power branding plate above the door.

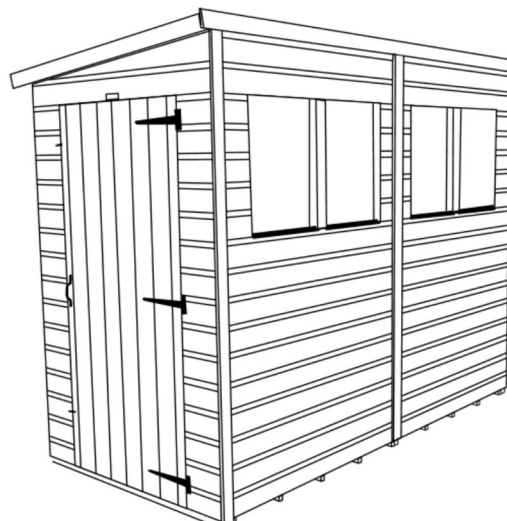

Aftercare & Maintenance

Seal Your Windows

We recommend windows are sealed externally with the application of silicone, putty or any other 'watertight' solution at your own preference.

Important

Please ensure you thoroughly seal the exterior bottom corners of the windows at the edge of the sill.

Shed Preserver

All our sheds come with our Power preservative.

It is important that you re-treat your Power shed annually with a high-quality wood preserver. Feel free to change the colour of the building giving you the '**power**' to style it your own way.

Take extra care to brush treatment into all wooden components inside and outside.

Please ensure there are no overhanging branches or debris on the shed as this can lead to water ingress.

USEFUL TIP – Looking for some inspiration?

Our Instagram has images of hundreds of Power Sheds which have all been sent to us by customers and is a great way to look at the different ways you can build and paint your shed!

Check Your Base

Although your base should be level at the time of assembly, some bases can move over time and if you find this occurs then the building can twist or door may not close properly.

If such occurrences you may need to pack up the base to keep the building level.

Share Your Shed

Here at Power we love to see your sheds!

Send us photos of your finished sheds to our social media channels using the following handles –

@PowerSheds

#PowerSheds



Instagram



Twitter



Facebook

Power Shed Shelving Instructions

Power Shed Shelving comes 4ft or 6ft long.

You will receive the following components in each shelving pack:

- (4x) board lengths (at either 4ft or 6ft depending what you ordered).
Please note: These are 70mm wide and are the same material as the bargeboards. Be careful not to use these during assembly of your Power Shed
- (3x) Brackets
- (2x) Batons
- (1x) Fixing pack - containing 70mm screws and 25mm screws.

Please note:

- When screwing the brackets into position, ensure they are fixed to the internal framing of the shed and not the cladding
 - You may have to cut the board lengths down with a saw to fit depending on the shed you have
1. Choose an appropriate location for your shelving and screw the brackets to the internal framing of the shed with the 70mm screws.
 2. Use a spirit level to ensure they are level.
Ensure the shelving bracket is the correct way up as per the diagram following:

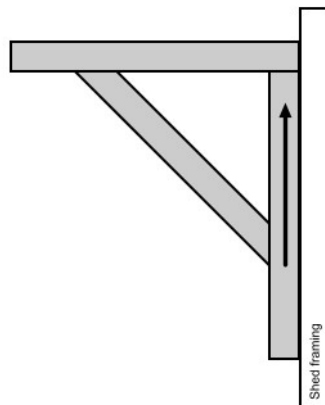

Depending on your shed, there may not be an appropriate place to secure your brackets or there may be framing in an unsuitable position (particularly if the shelf is going on a gable end). We have therefore sent some additional batons to use if required.

After the brackets are attached to the framing of the side walls, you can fix the shelving board lengths into the brackets which the 25mm screws. There should be two screws per board per bracket. There should be a small gap between each board length

Power Two-Tiered Staging Unit Installation Instructions

Power Shed Staging Units come at either 2ft or 4ft long.

You will receive the following components in each **individual** staging pack:

- (2x) Shelving Panels (either 2ft or 4ft)
- (2x) Legs (for the front of the panels only)

Please note:

- Depending on where you decide to install the staging units – you may need to cut the panels down. Before attaching the panels to the framing ensure they are correctly sized.
- Use 70mm screws from the fixing pack to attach the shelving panels to the framing.
- When screwing the shelving into position, ensure they are fixed to the internal framing of the shed and not the cladding

1. The staging units are designed to fit our Power Potting Shed window panels (however can be attached to any shed in our range), being fixed against the internal framing of the shed with the 70mm screws.
2. Use a spirit level to ensure they are level. We would recommend to pre-drill the holes for the screws to ensure the timber does not split.

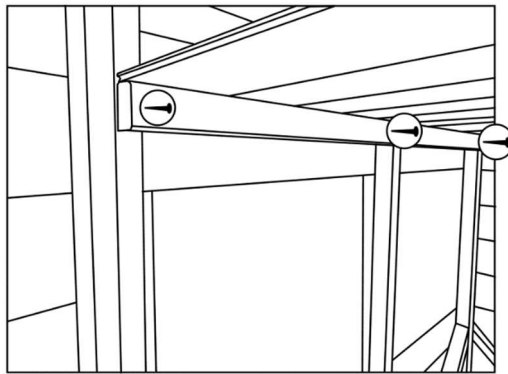

3. Fix the legs to the shelves, once again using the 70mm screws.
After these are added continue adding each additional staging unit (if necessary) securing batons as you go.

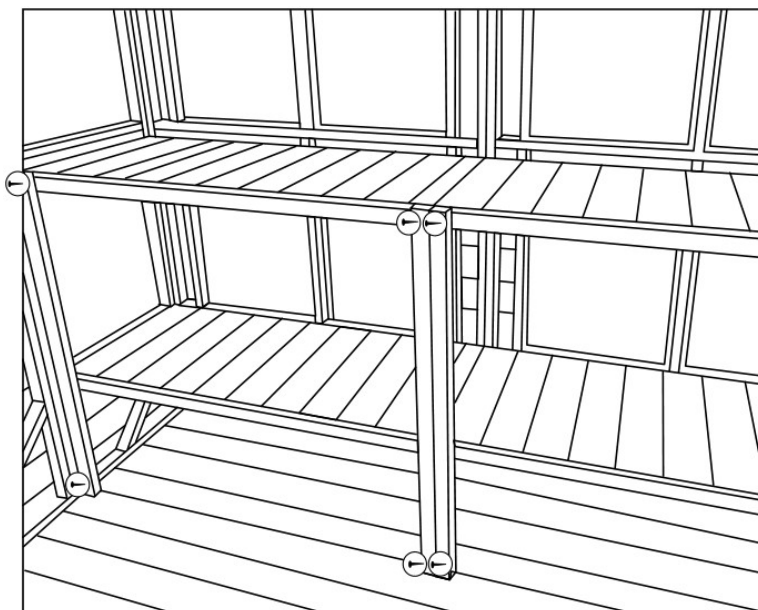

Returns

If Power is not for you and you'd like to return your shed within 14 days of delivery then we will collect the item from you without charging a collection fee. No fuss, no fees!

All we ask is that you **do not unpack** the shed or take the shed off the pallet. You will be able to see the shed panels on the pallet if you want to double check the quality of the shed panels.

You need to notify the company you ordered your garden building from to arrange a cancellation or return.

If you have unpacked the shed or taken the shed off the pallet, then you can still return the product to us providing it is within 14 days of delivery but you will have to cover the cost of returning the item. This will either need to be arranging the delivery yourself (to our manufacturing unit in West Yorkshire) or repacking and securing the goods back onto the pallet and we can arrange a pallet delivery for you. The cost of this will depend on your location and the item bought – please contact us if you would like us to advise the cost of this. In this case we will not profit from any courier charges but simply pass on the cost we receive to you.

Any delivery surcharges you have paid (such as a quicker delivery, Saturday delivery, or a timed delivery) will not be refunded.

Once your item has been returned it will be checked to ensure it is complete and in a re-sellable condition. If we deem that the product is not in a re-sellable condition we shall deduct a reasonable amount to cover any costs to use or return them to you.

Where a refund is to be paid we will usually refund any money received from you using the same method originally used by you to pay for your purchase.

Contact Us

If you have any queries or issues with your shed then you can:

- Check out our FAQ page on www.PowerSheds.com
- Email us at hello@PowerSheds.com
Please provide photographs of any reported issues*
Any replacement parts can take 1-3 working days.
- Contact us via the telephone – 01274 036 577 (Mon-Fri 08:00 - 16:30)
- Write to us at: Power Sheds Ltd
21 Comondale Way
Euroway Trading Estate
Bradford
BD4 6SF

- * On the rare occasion that something is missing, please contact us to make us aware so we can send out any replacements. Replacement parts will be dispatched within 1-3 working days.
- * Please be aware we are unable to reimburse you if you purchase your own materials.
- * We also cannot compensate for subsequential losses such as installation work.