

ASSEMBLY INSTRUCTIONS

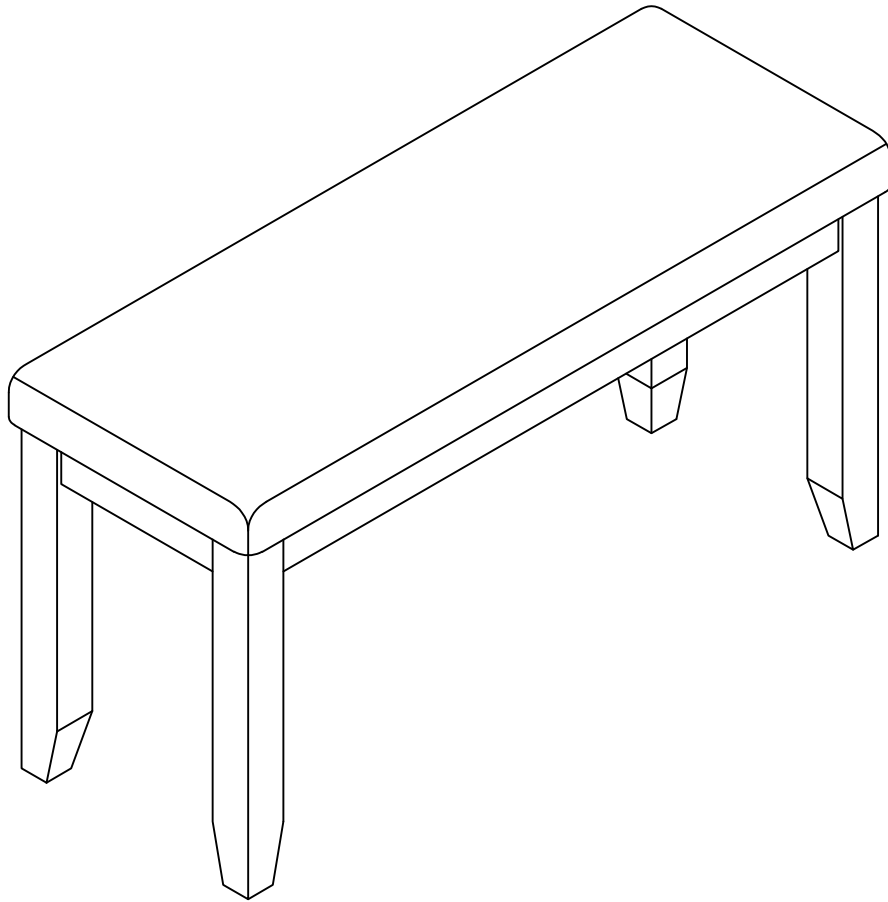





DINING BENCH

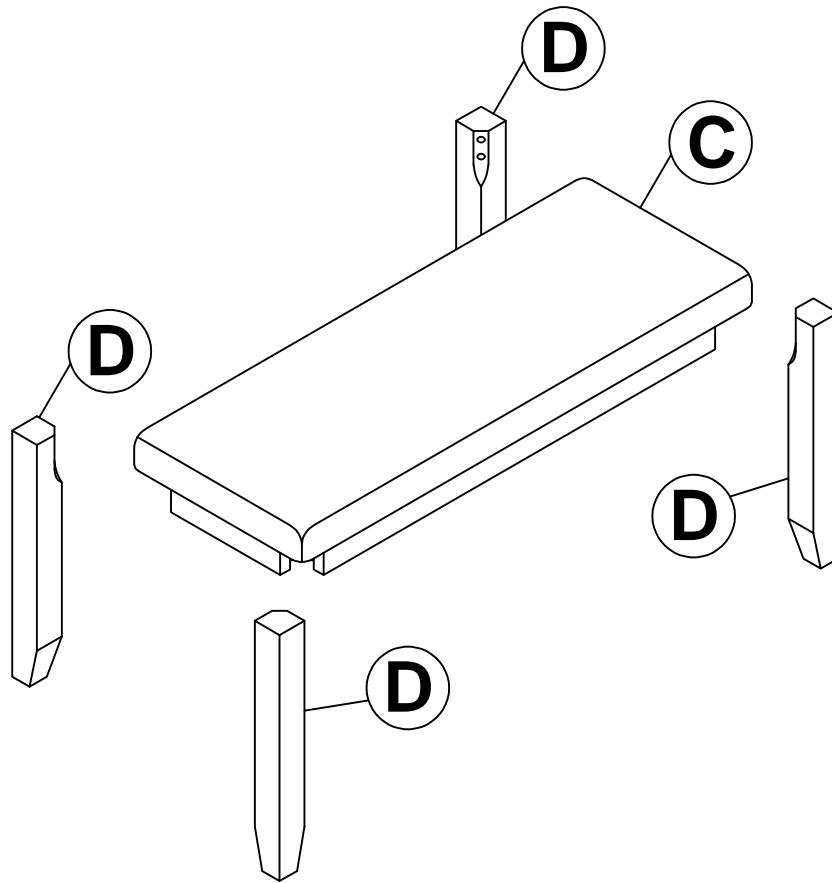

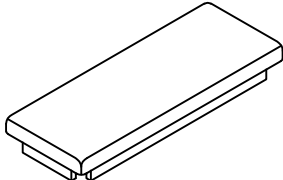
IMPORTANT NOTE :

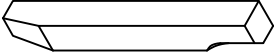
- ① PLACE ALL PARTS ON A CLEAN AND SMOOTH SURFACE SUCH AS A RUG OR CARPET TO AVOID THE PARTS FROM BEING SCRATCHED.
- ② BEFORE YOU BEGIN , KINDLY FOLLOW THE ASSEMBLY INSTRUCTIONS STEP BY STEP.
- ③ DO NOT TIGHTEN ALL SCREWS AND BOLTS UNTIL THE BENCH IS FULLY SET-UP



Part List	Hardware List
<p>C</p>  <p>SEAT BENCH (1pc)</p>	<p>5</p>  <p>Ø5/16" x 60mm</p> <p>BOLT (8pcs)</p>
<p>D</p>  <p>LEGS BENCH (4pcs)</p>	<p>6</p>  <p>Ø5/16" x 13mm</p> <p>SPRING WASHER (8pcs)</p>
	<p>7</p>  <p>Ø5/16" x 19mm</p> <p>FLAT WASHER (8pcs)</p>
	<p>8</p>  <p>4mm</p> <p>ALLENKEY (1pc)</p>

